



VISUAL

# french english

le petit déjeuner  
breakfast

le croissant  
croissant

le café  
coffee

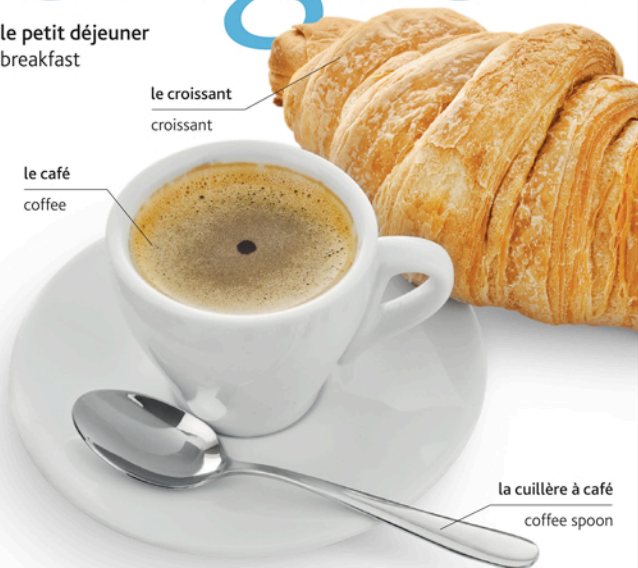

la cuillère à café  
coffee spoon

BILINGUAL  
DICTIONARY

WWW.EBOOK777.COM





# Bilingual **VISUAL** dictionary

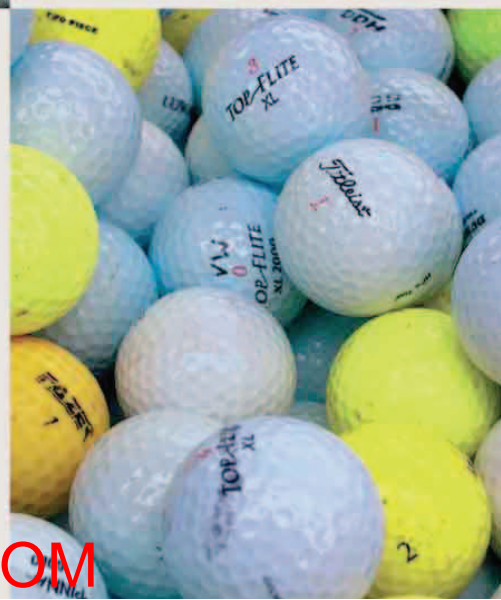

# Bilingual VISUAL dictionary

Previously published as part of  
*5-Language Visual Dictionary*



[WWW.EBOOK777.COM](http://WWW.EBOOK777.COM)



Penguin  
Random  
House

Senior Editor Angeles Gavira

Senior Art Editor Ina Stradins

DTP Designers Sunil Sharma, Balwant Singh,  
Harish Aggarwal, John Goldsmid, Ashwani Tyagi

DTP Coordinator Pankaj Sharma

Production Controller Liz Cherry

Picture Researcher Anna Grapes

Managing Editor Liz Wheeler

Managing Art Editor Phil Ormerod

Category Publisher Jonathan Metcalf

Designed for Dorling Kindersley by WaltonCreative.com

Art Editor Colin Walton, assisted by Tracy Musson

Designers Peter Radcliffe, Earl Neish, Ann Cannings

Picture Research Marissa Keating

Language content for Dorling Kindersley by  
g-and-w PUBLISHING

Managed by Jane Wightwick, assisted by Ana Bremón

Translation and editing by Christine Arthur

Additional input by Dr. Arturo Pretel, Martin Prill,

Frédéric Monteil, Meinrad Prill, Mari Bremón,

Oscar Bremón, Anunchi Bremón, Leila Gaafar

First American Edition, 2009

This edition published in the United States in 2015

by DK Publishing, 345 Hudson Street, New York,  
New York 10014

Copyright © 2015 Dorling Kindersley Limited

A Penguin Random House Company

15 16 17 18 19 10 9 8 7 6 5 4 3 2 1

001 – 283035 – June/15

All rights reserved.

Without limiting the rights under the copyright reserved  
above, no part of this publication may be reproduced,  
stored in or introduced into a retrieval system, or transmitted,  
in any form, or by any means (electronic, mechanical,  
photocopying, recording, or otherwise), without the prior  
written permission of the copyright owner.

Published in Great Britain by Dorling Kindersley Limited.

A catalog record for this book is available from the  
Library of Congress.

ISBN: 978-1-4654-3630-6

DK books are available at special discounts when purchased  
in bulk for sales promotions, premiums, fund-raising, or  
educational use. For details, contact: DK Publishing Special  
Markets, 345 Hudson Street, New York, New York 10014  
SpecialSales@dk.com

Printed and bound in China

All images © Dorling Kindersley Limited

For further information see: [www.dkimages.com](http://www.dkimages.com)

A WORLD OF IDEAS:  
SEE ALL THERE IS TO KNOW

[www.dk.com](http://www.dk.com)

## table des matières contents

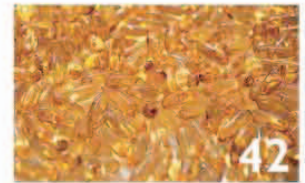

42

la santé  
health



146

sortir manger  
eating out



252

le temps libre  
leisure

[WWW.EBOOK777.COM](http://WWW.EBOOK777.COM)



8

**à propos du  
dictionnaire**  
about the dictionary



9

**comment utiliser  
ce livre**  
how to use this book



10

**les gens**  
people



28

**l'apparence**  
appearance



56

**la maison**  
home



92

**les services**  
services



102

**les courses**  
shopping



116

**la nourriture**  
food



160

**l'étude**  
study



170

**le travail**  
work



192

**le transport**  
transportation



218

**les sports**  
sports



278

**l'environnement**  
environment



302

**l'information**  
reference



324

**index**  
index



360

**remerciements**  
acknowledgments

**les gens • people**

**le corps** | body 12  
**le visage** | face 14  
**la main** | hand 15  
**le pied** | foot 15  
**les muscles** | muscles 16  
**le squelette** | skeleton 17  
**les organes internes**  
 internal organs 18  
**les organes de reproduction**  
 reproductive organs 20  
**la famille** | family 22  
**les relations**  
 relationships 24  
**les émotions** | emotions 25  
**les événements de la vie**  
 life events 26

**l'apparence • appearance**

**les vêtements d'enfants**  
 children's clothing 30  
**les vêtements pour hommes**  
 men's clothing 32  
**les vêtements pour femmes**  
 women's clothing 34  
**les accessoires** | accessories 36  
**les cheveux** | hair 38  
**la beauté** | beauty 40

**la santé • health**

**la maladie** | illness 44  
**le médecin** | doctor 45  
**la blessure** | injury 46  
**les premiers secours**  
 first aid 47  
**l'hôpital** | hospital 48  
**le dentiste** | dentist 50  
**l'opticien** | optometrist 51

**la grossesse** | pregnancy 52  
**la naissance** | childbirth 53  
**les thérapies alternatives**  
 complementary therapy 54

**la maison • home**

**la maison** | house 58  
**les systèmes domestiques**  
 internal systems 60  
**le salon** | living room 62  
**la salle à manger**  
 dining room 64  
**la cuisine** | kitchen 66  
**les ustensiles de cuisine**  
 kitchenware 68  
**la chambre** | bedroom 70  
**la salle de bain**  
 bathroom 72  
**la chambre d'enfants**  
 baby's room 74  
**la buanderie** | utility room 76  
**l'atelier** | workshop 78  
**la boîte à outils**  
 toolbox 80  
**la décoration** | decorating 82  
**le jardin** | garden 84  
**les plantes de jardin**  
 garden plants 86  
**les outils de jardin**  
 garden tools 88  
**le jardinage** | gardening 90  
**les services • services**  
**les services d'urgence**  
 emergency services 94  
**la banque** | bank 96

**les communications** 98  
 communications  
**l'hôtel** | hotel 100

**les courses • shopping**

**le centre commercial** 104  
 shopping centre  
**le grand magasin** 105  
 department store  
**le supermarché** 106  
 supermarket  
**la pharmacie** | pharmacy 108  
**le fleuriste** | florist 110  
**le marchand de journaux**  
 newsagent 112  
**le confiseur** | confectionery 113  
**les autres magasins** 114  
 other shops

**la nourriture • food**

**la viande** | meat 118  
**le poisson** | fish 120  
**les légumes** | vegetables 122  
**le fruit** | fruit 126  
**les céréales et les légumes secs** | grains and legumes 130  
**les herbes et les épices**  
 herbs and spices 132  
**les aliments en bouteilles**  
 bottled foods 134  
**les produits laitiers** 136  
 dairy produce  
**les pains et la farine** 138  
 breads and flours  
**les gâteaux et les desserts** 140  
 cakes and desserts  
**la charcuterie** | delicatessen 142  
**les boissons** | drinks 144



**sortir manger •**

eating out

le café   café	148
le bar   bar	150
le restaurant   restaurant	152
la restauration rapide fast food	154
le petit déjeuner   breakfast	156
le repas   dinner	158

**l'étude • study**

l'école   school	162
les mathématiques   maths	164
la science   science	166
l'enseignement supérieur college	168

**le travail • work**

le bureau   office	172
l'ordinateur   computer	176
les médias   media	178
le droit   law	180
la ferme   farm	182
la construction   construction	186
les professions   professions	188

**le transport •  
transportation**

les routes   roads	194
le bus   bus	196
la voiture   car	198
la moto   motorcycle	204
la bicyclette   bicycle	206
le train   train	208
l'avion   aircraft	210
l'aéroport   airport	212
le navire   ship	214
le port   port	216

**les sports • sport**

le football américain football	220
le rugby   rugby	221
le football   soccer	222
le hockey   hockey	224
le cricket   cricket	225
le basket   basketball	226
le baseball   baseball	228
le tennis   tennis	230
le golf   golf	232
l'athlétisme   track and field	234
les sports de combat combat sports	236
la natation   swimming	238
la voile   sailing	240
l'équitation   horseback riding	242
la pêche   fishing	244
le ski   skiing	246
les autres sports other sports	248
le conditionnement physique fitness	250

**le temps libre •  
leisure**

le théâtre   theater	254
l'orchestre   orchestra	256
le concert   concert	258
le tourisme   sightseeing	260
les activités de plein air outdoor activities	262
la plage   beach	264
le camping   camping	266
les distractions à la maison home entertainment	268
la photographie photography	270
les jeux   games	272



les arts et métiers arts and crafts	274
--	-----

**l'environnement •  
environment**

l'espace   space	280
la terre   Earth	282
le paysage   landscape	284
le temps   weather	286
les roches   rocks	288
les minéraux   minerals	289
les animaux   animals	290
les plantes   plants	296
la ville   town	298
l'architecture architecture	300

**l'information •  
reference**

l'heure   time	304
le calendrier   calendar	306
les nombres   numbers	308
les poids et mesures weights and measures	310
la carte du monde world map	312
particules et antonymes particles and antonyms	320
phrases utiles   useful phrases	322

## à propos du dictionnaire

Il est bien connu que les illustrations nous aident à comprendre et retenir l'information. Fondé sur ce principe, ce dictionnaire bilingue richement illustré présente un large éventail de vocabulaire courant et utile dans deux langues européennes.

Le dictionnaire est divisé de façon thématique et couvre en détail la plupart des aspects du monde quotidien, du restaurant au gymnase, de la maison au lieu de travail, de l'espace au monde animal. Vous y trouverez également des mots et expressions supplémentaires pour la conversation et pour enrichir votre vocabulaire.

Il s'agit d'un outil de référence essentiel pour tous ceux qui s'intéressent aux langues – pratique, stimulant et d'emploi facile.

### Quelques points à noter

Les deux langues sont toujours présentées dans le même ordre – français et anglais.

Les noms sont donnés avec leurs articles définis qui indiquent leur genre (masculin ou féminin) et leur nombre (singulier ou pluriel):

<b>la graine</b>	<b>les amandes</b>
seed	almonds

Les verbes sont indiqués par un (v), par exemple:

**récolter** • harvest (v)

Chaque langue a également son propre index à la fin du livre. Vous pourrez y vérifier un mot dans n'importe laquelle des deux langues et vous serez renvoyé au(x) numéro(s) de(s) page(s) où il figure. Le genre est indiqué par les abréviations suivantes:

m = masculin  
f = féminin

## about the dictionary

The use of pictures is proven to aid understanding and the retention of information. Working on this principle, this highly-illustrated bilingual dictionary presents a large range of useful current vocabulary in two European languages.

The dictionary is divided thematically and covers most aspects of the everyday world in detail, from the restaurant to the gym, the home to the workplace, outer space to the animal kingdom. You will also find additional words and phrases for conversational use and for extending your vocabulary.

This is an essential reference tool for anyone interested in languages – practical, stimulating, and easy-to-use.

### A few things to note

The two languages are always presented in the same order – French and English.

Nouns are given with their definite articles reflecting the gender (masculine or feminine) and number (singular or plural), for example:

<b>la graine</b>	<b>les amandes</b>
seed	almonds

Verbs are indicated by a (v) after the English—for example:

**récolter** • harvest (v)

Each language also has its own index at the back of the book. Here you can look up a word in either of the two languages and be referred to the page number(s) where it appears. The gender is shown using the following abbreviations:

m = masculine  
f = feminine



## comment utiliser ce livre

Que vous appreniez une nouvelle langue pour les affaires, le plaisir ou pour préparer vos vacances, ou encore si vous espérez élargir votre vocabulaire dans une langue qui vous est déjà familière, ce dictionnaire sera pour vous un outil d'apprentissage précieux que vous pourrez utiliser de plusieurs manières.

Lorsque vous apprenez une nouvelle langue, recherchez les mots apparentés (mots qui se ressemblent dans différentes langues) et les faux amis (mots qui se ressemblent mais ont des significations nettement différentes). Par exemple, l'anglais a importé des autres langues européennes de nombreux termes désignant la nourriture mais, en retour, exporté des termes employés dans le domaine de la technologie et de la culture populaire.

### Activités pratiques d'apprentissage

- Lorsque vous vous déplacez dans votre maison, au travail ou à l'université, essayez de regarder les pages qui correspondent à ce contexte. Vous pouvez ensuite fermer le livre, regarder autour de vous et voir combien d'objets vous pouvez nommer.
- Forcez-vous à écrire une histoire, une lettre ou un dialogue en employant le plus de termes possibles choisis dans une page. Ceci vous aidera à retenir le vocabulaire et son orthographe. Si vous souhaitez pouvoir écrire un texte plus long, commencez par des phrases qui incorporent 2 à 3 mots.
- Si vous avez une mémoire très visuelle, essayez de dessiner ou de décalquer des objets du livre sur une feuille de papier, puis fermez le livre et inscrivez les mots sous l'image.
- Une fois que vous serez plus sûr de vous, choisissez des mots dans l'index de la langue étrangère et essayez de voir si vous en connaissez le sens avant de vous reporter à la page correspondante pour vérifier.

## how to use this book

Whether you are learning a new language for business, pleasure, or in preparation for an overseas vacation, or are hoping to extend your vocabulary in an already familiar language, this dictionary is a valuable learning tool that you can use in a number of different ways.

When learning a new language, look for cognates (words that are alike in different languages) and "false friends" (words that look alike but carry significantly different meanings). You can also see where the languages have influenced each other. For example, English has imported many terms for food from other European languages but, in turn, exported terms used in technology and popular culture.

### Practical learning activities

- As you move around your home, workplace, or school, try looking at the pages which cover that setting. You could then close the book, look around you, and see how many of the objects and features you can name.
- Challenge yourself to write a story, letter, or dialogue using as many of the terms on a particular page as possible. This will help you retain the vocabulary and remember the spelling. If you want to build up to writing a longer text, start with sentences incorporating 2–3 words.
- If you have a very visual memory, try drawing or tracing items from the book onto a piece of paper, then closing the book and filling in the words below the picture.
- Once you are more confident, pick out words in a foreign-language index and see if you know what they mean before turning to the relevant page to see if you were right.





[WWW.EBOOK777.COM](http://WWW.EBOOK777.COM)



les gens  
people

[WWW.EBOOK777.COM](http://WWW.EBOOK777.COM)

# le corps • body

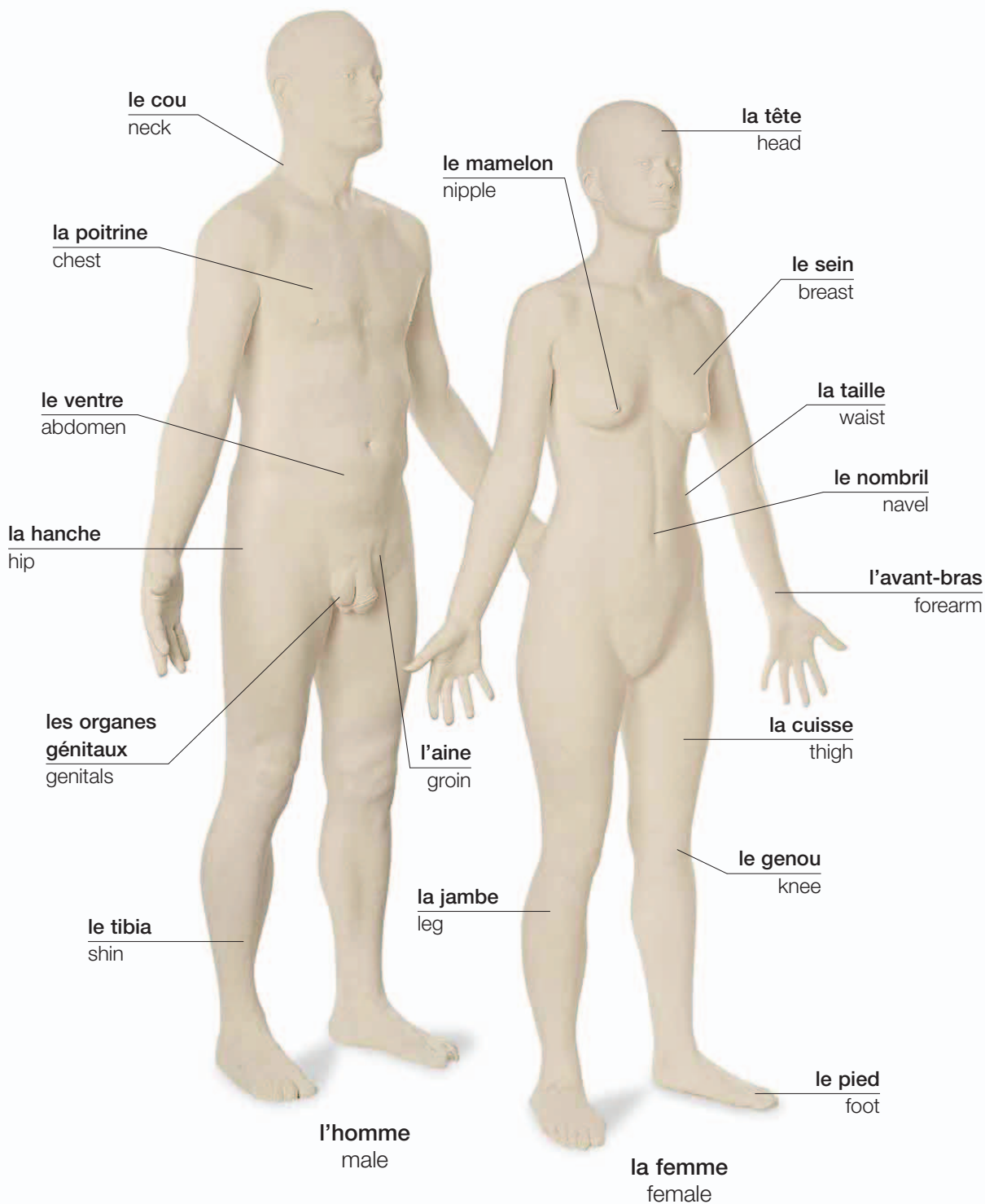

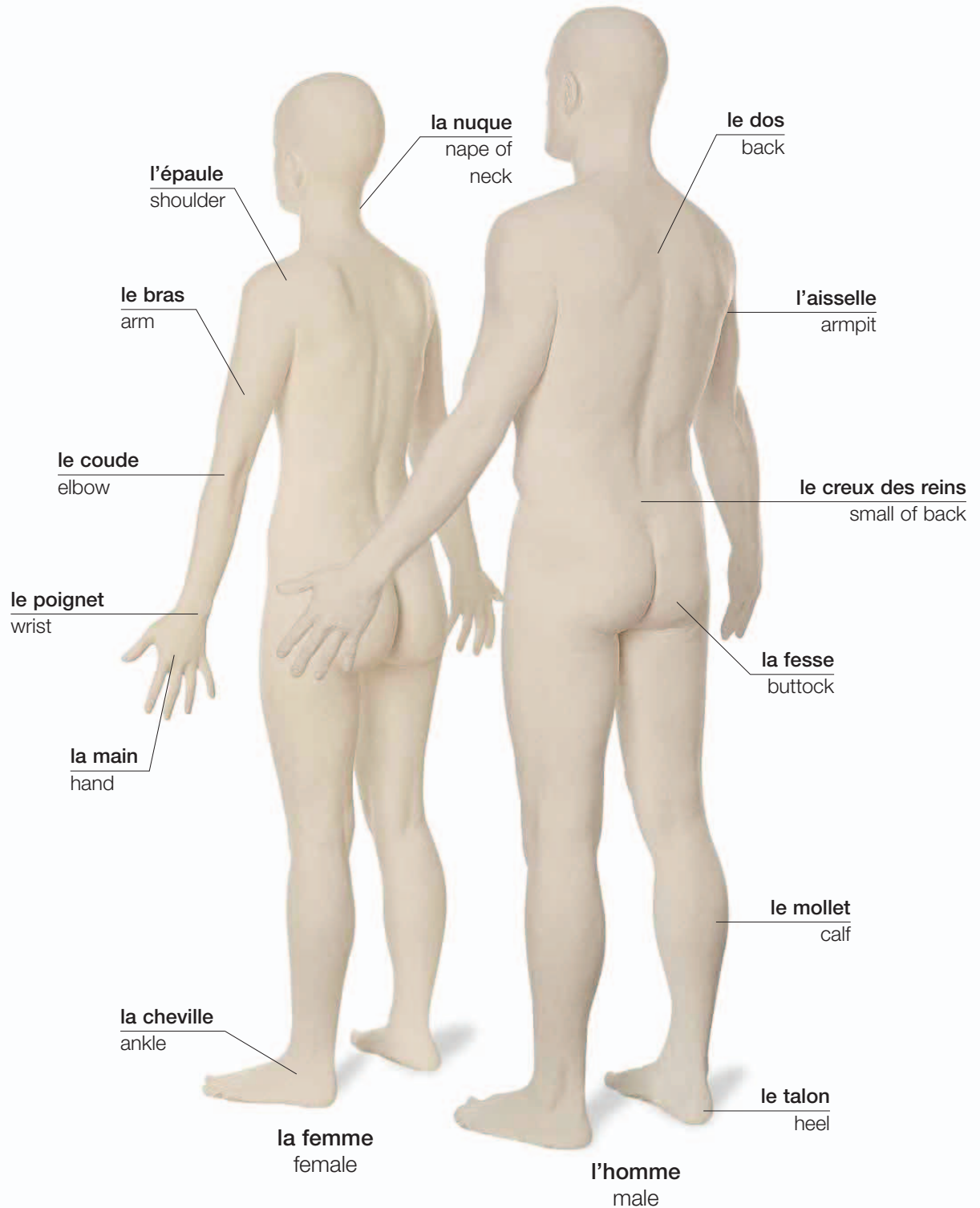

# le visage • face

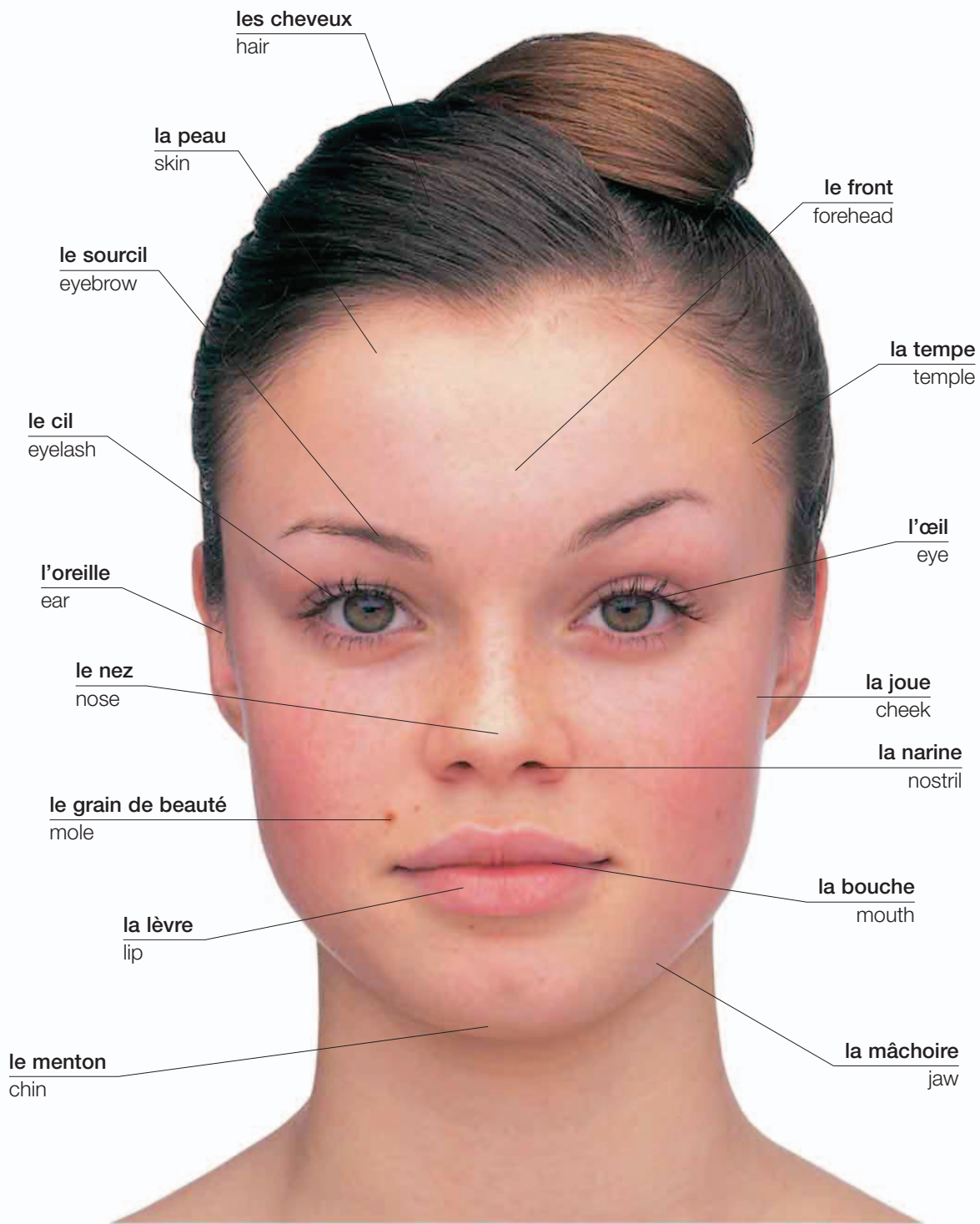





**la ride**  
wrinkle

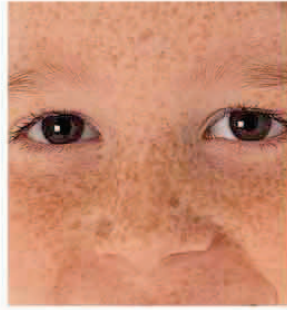

**la tache de rousseur**  
freckle

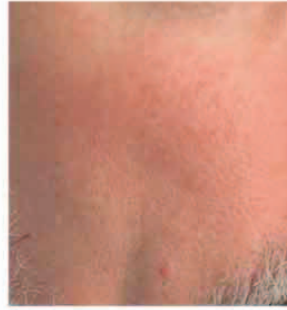

**le pore**  
pore

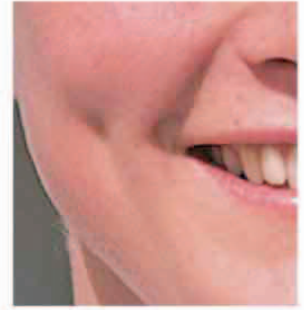

**la fossette**  
dimple

## la main • hand

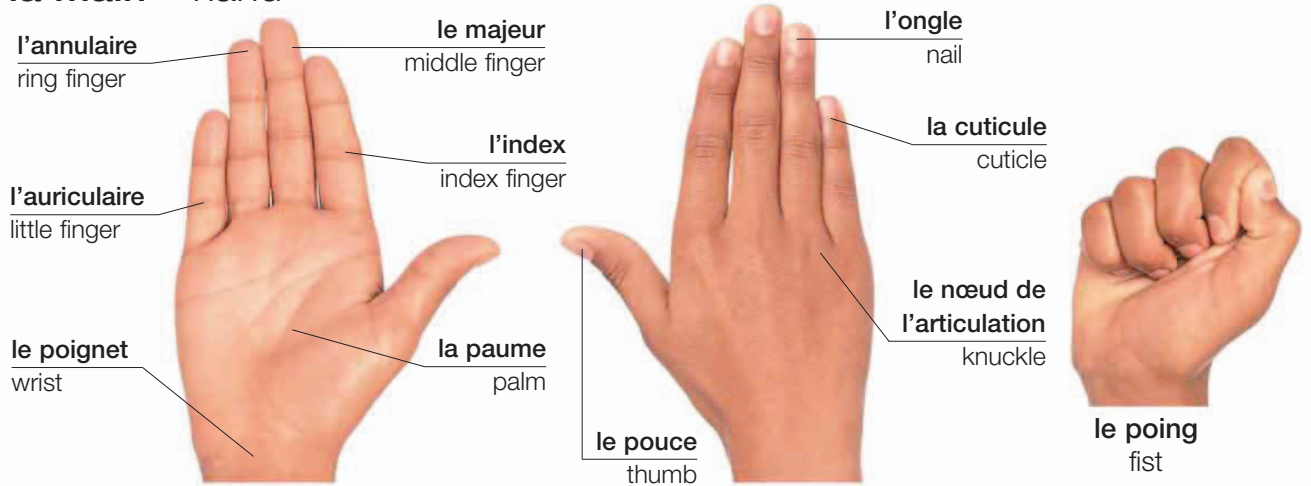

## le pied • foot

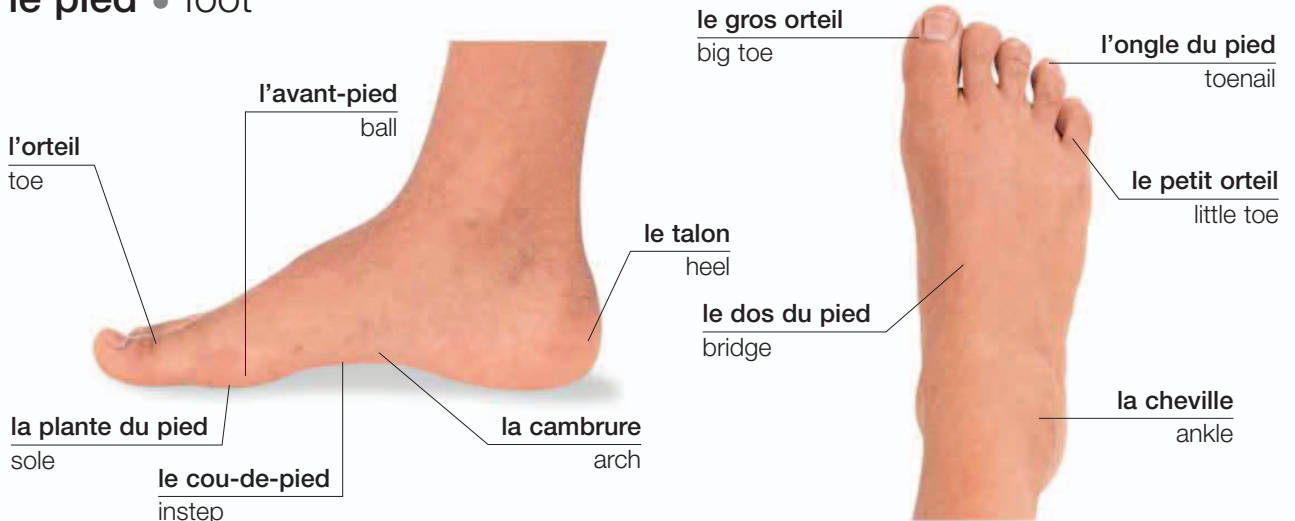

# les muscles • muscles

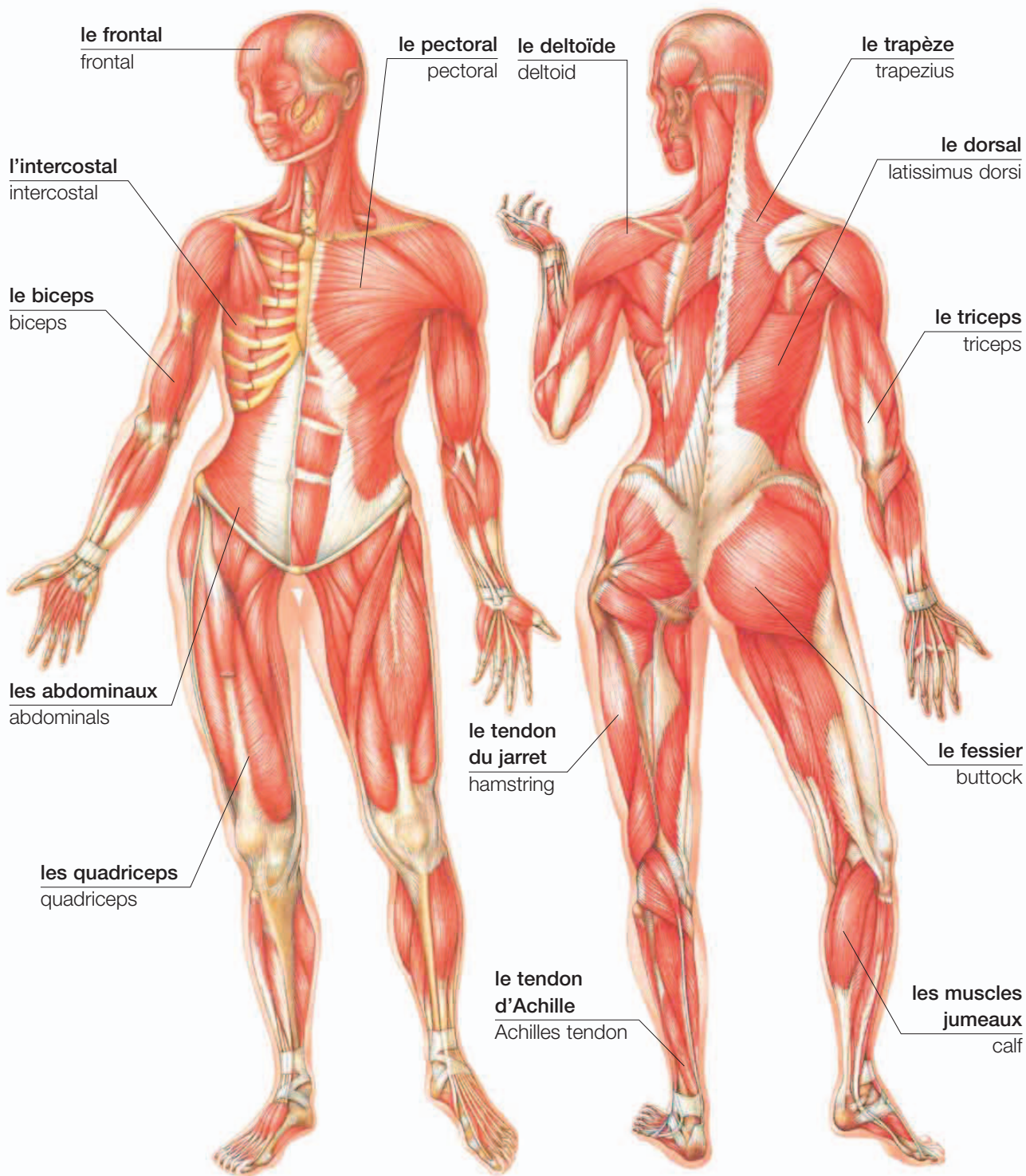

# le squelette • skeleton

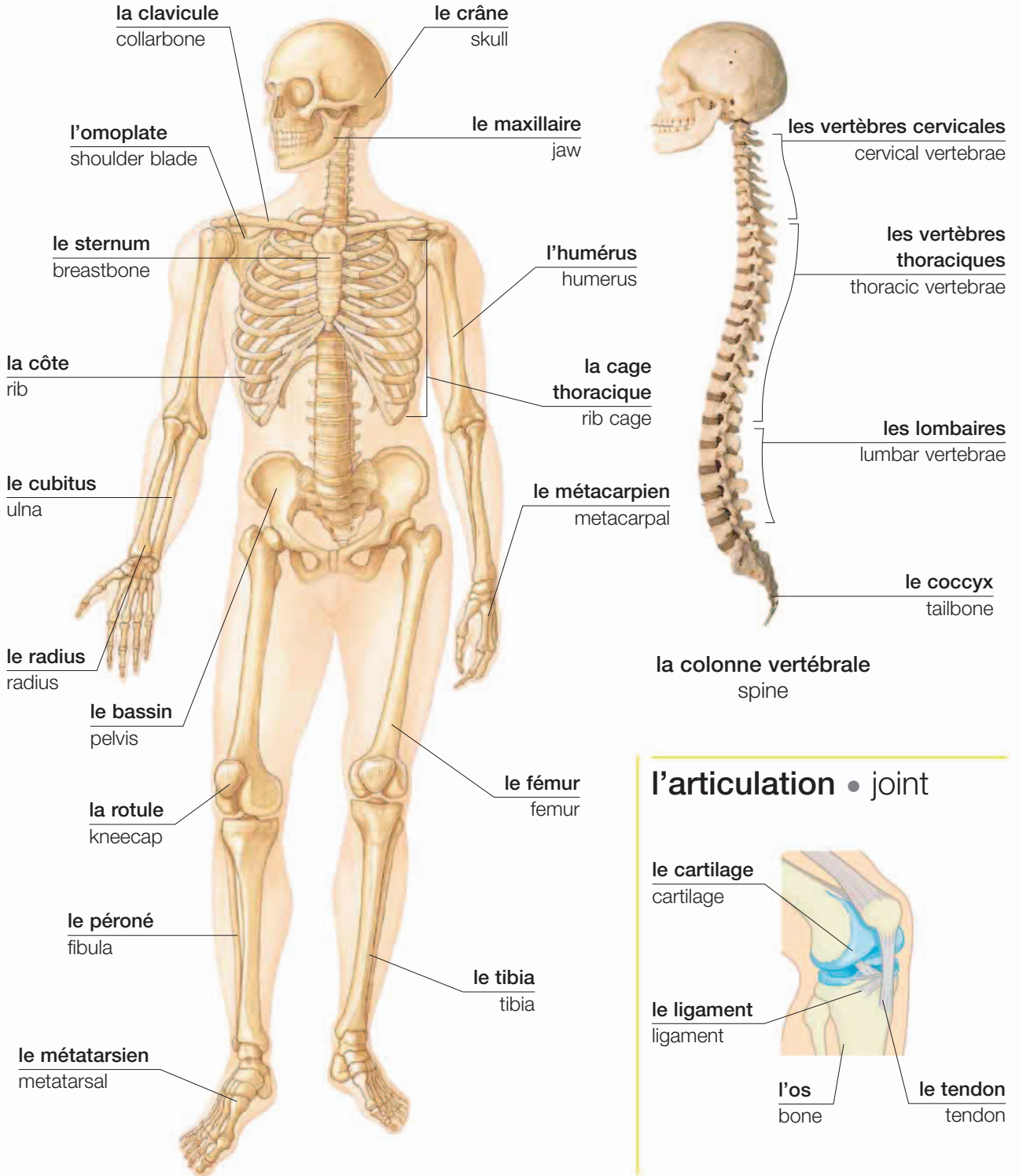

# les organes internes • internal organs

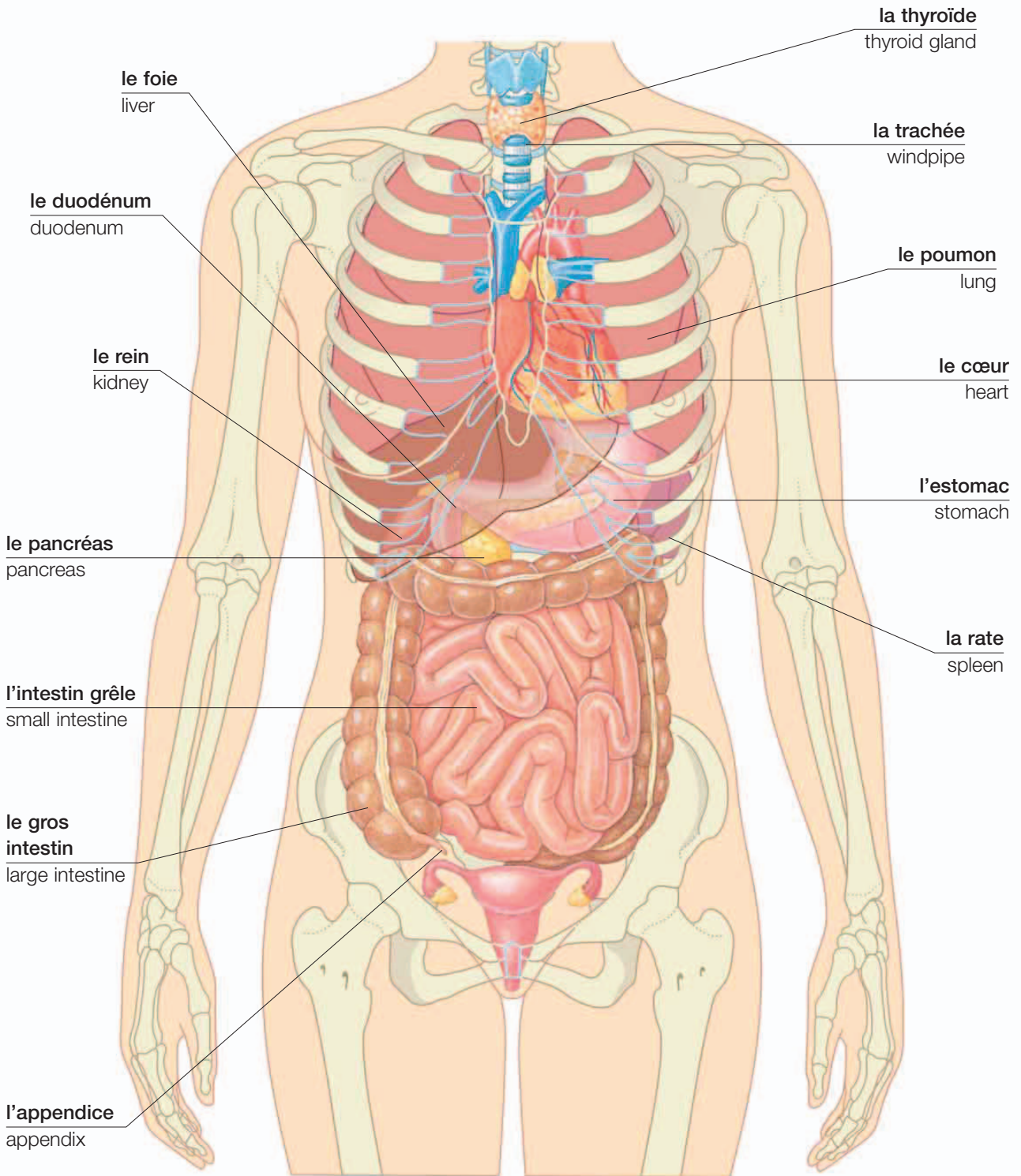

la tête • head

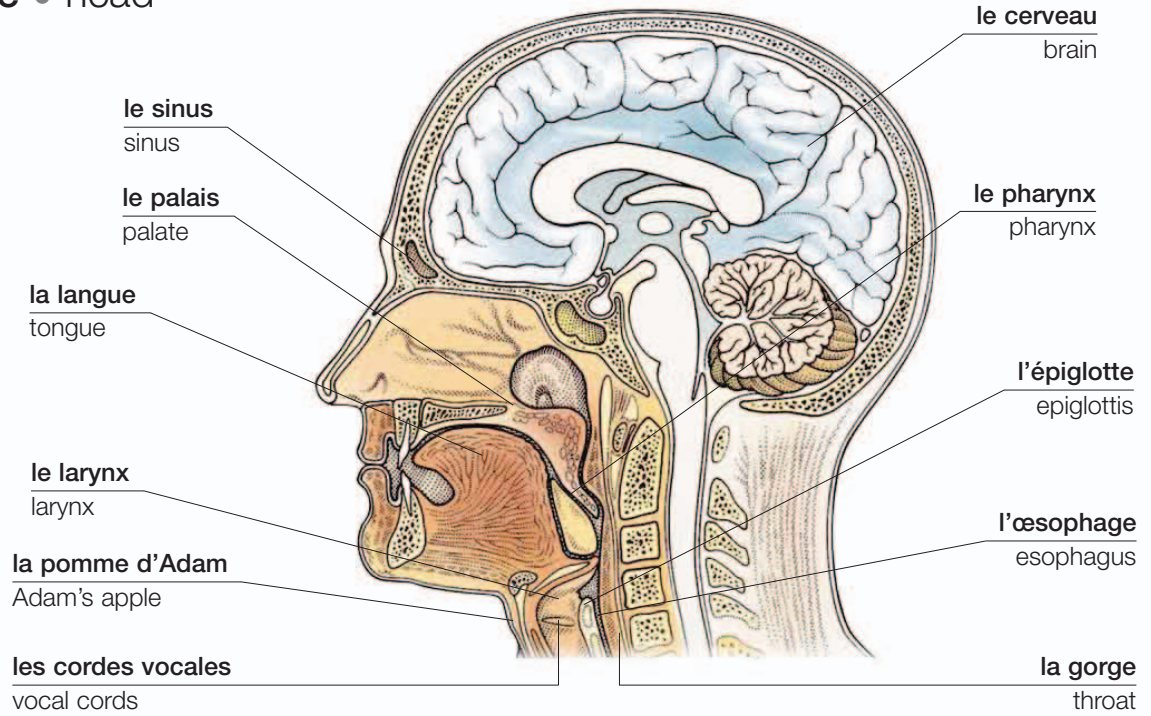

les systèmes du corps • body systems

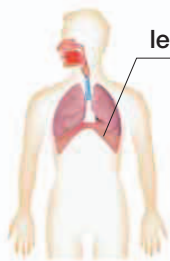

respiratoire  
respiratory

le diaphragme  
diaphragm

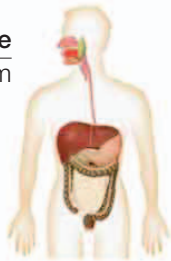

digestif  
digestive

la veine  
vein



cardio-vasculaire  
cardiovascular

l'artère  
artery



lymphatique  
lymphatic

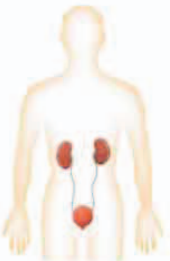

urinaire  
urinary

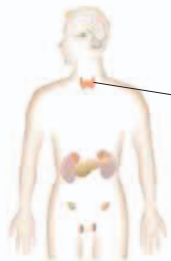

endocrine  
endocrine

la glande  
gland



nerveux  
nervous

le nerf  
nerve



reproducteur  
reproductive

# les organes de reproduction • reproductive organs

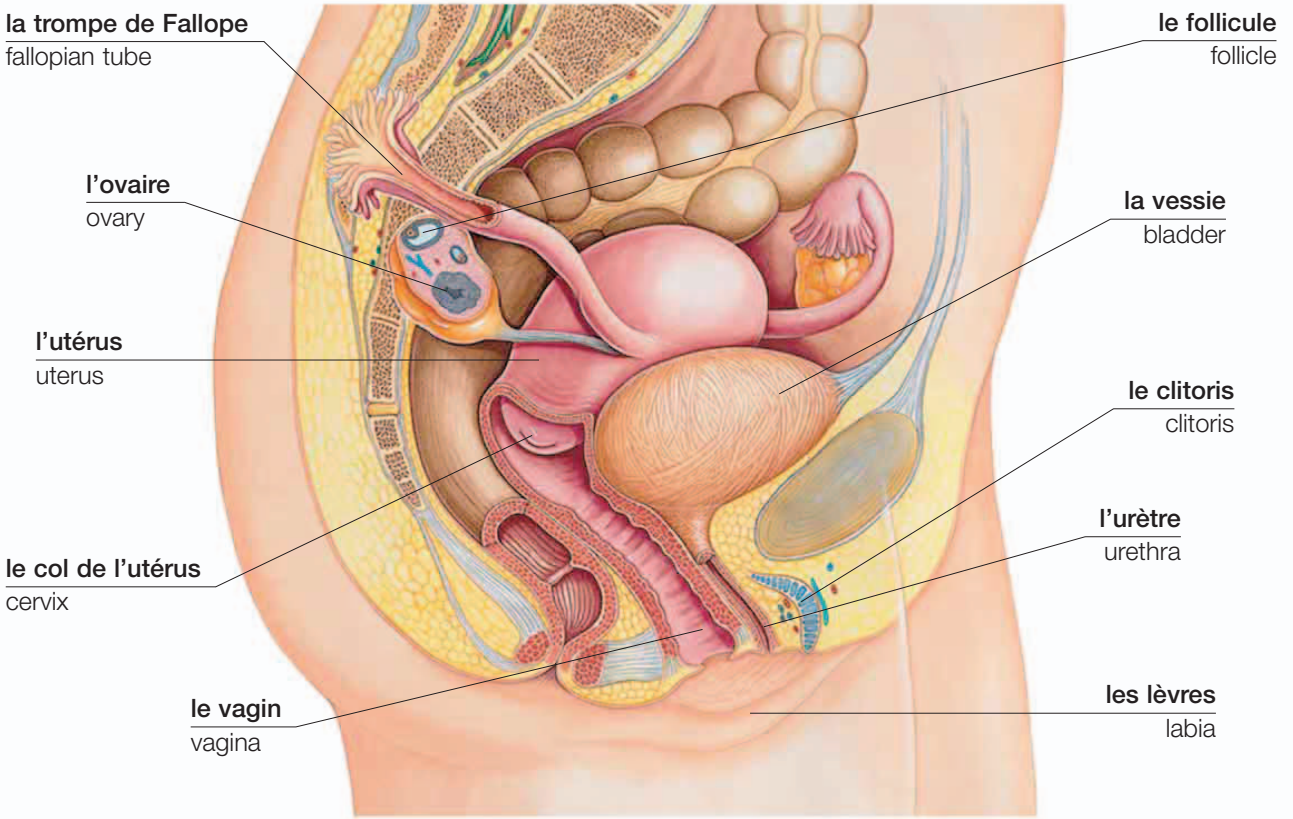

féminin | female

## la reproduction • reproduction

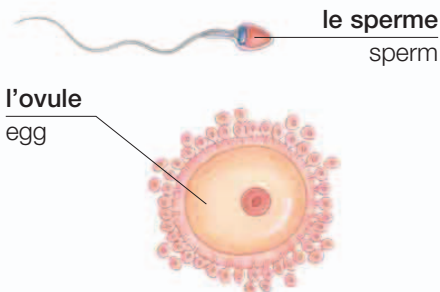

la féertilisation | fertilization

## vocabulaire • vocabulary

**l'hormone**  
hormone

**impuissant**  
impotent

**les règles**  
menstruation

**l'ovulation**  
ovulation

**fécond**  
fertile

**les rapports sexuels**  
intercourse

**stérile**  
infertile

**concevoir**  
conceive

**la maladie sexuellement transmissible**  
sexually transmitted disease

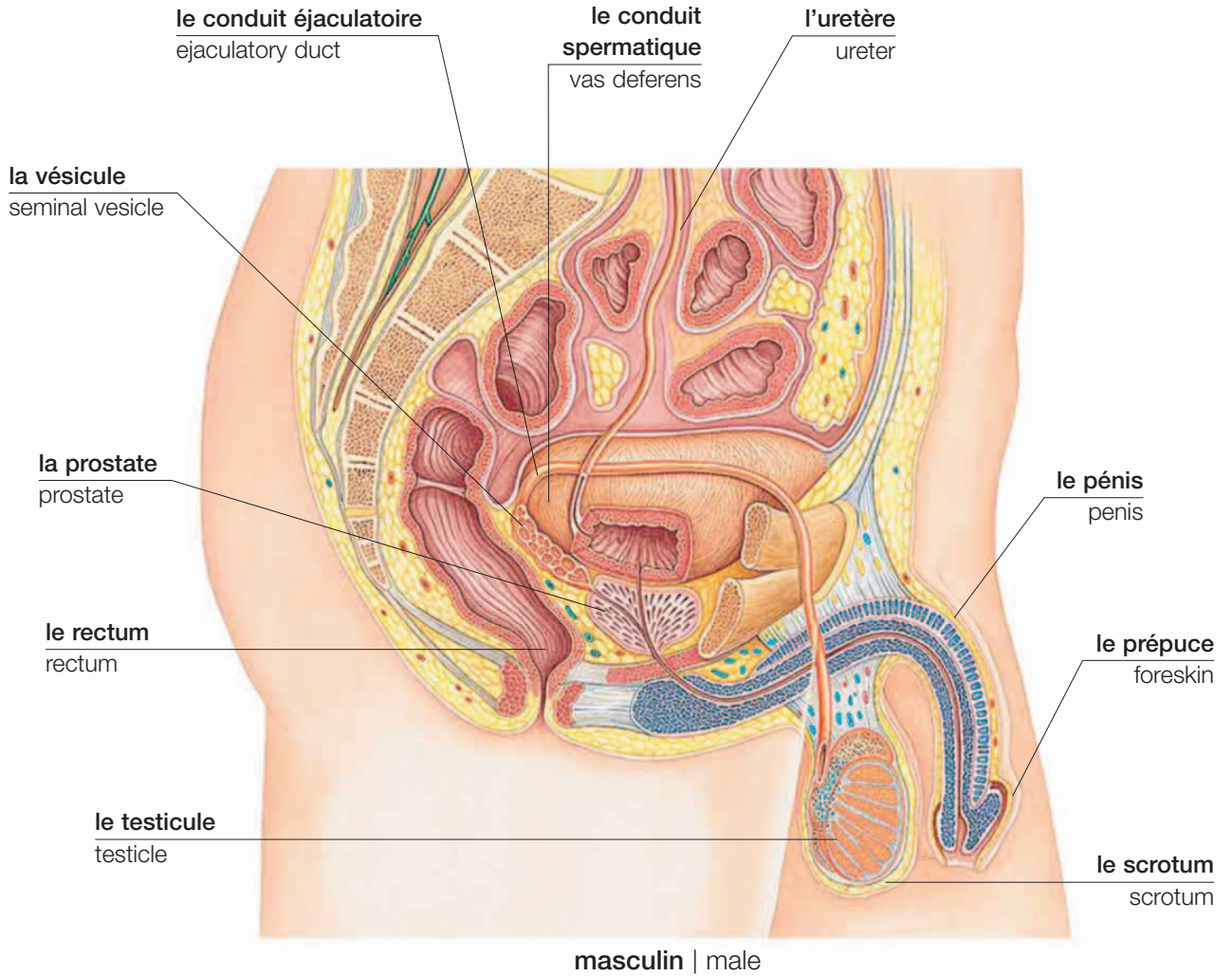

la contraception • contraception



# la famille • family





**vocabulaire** • vocabulary

<b>les parents</b> relatives	<b>les parents</b> parents	<b>les petits-enfants</b> grandchildren	<b>la belle-mère</b> stepmother	<b>le beau-fils</b> stepson	<b>la génération</b> generation
<b>les grands-parents</b> grandparents	<b>les enfants</b> children	<b>le beau-père</b> stepfather	<b>la belle-fille</b> stepdaughter	<b>le/la partenaire</b> partner	<b>les jumeaux</b> twins



**la belle-mère**  
mother-in-law



**le beau-père**  
father-in-law



**le beau-frère**  
brother-in-law



**la belle-sœur**  
sister-in-law



**la nièce**  
niece



**le neveu**  
nephew

**Mademoiselle**  
Miss

**les titres** • titles

**Madame**  
Mrs.

**Monsieur**  
Mr.



**les stades** • stages



**le bébé**  
baby



**l'enfant**  
child



**le garçon**  
boy



**la fille**  
girl



**l'adolescente**  
teenager



**l'adulte**  
adult



**l'homme**  
man



**la femme**  
woman

# les relations • relationships

**l'assistante**  
assistant

**le chef**  
manager



**l'associée**  
business partner

**l'employeur**  
employer

**l'employée**  
employee

**le collègue**  
colleague



**le bureau** | office



**le voisin**  
neighbor



**l'ami**  
friend



**la connaissance**  
acquaintance



**le correspondant**  
pen pal

**le petit ami**  
boyfriend



**le couple** | couple

**la petite amie**  
girlfriend

**le fiancé**  
fiancé



**les fiancés** | engaged couple

**la fiancée**  
fiancée

# les émotions • emotions



le sourire  
smile

**heureux**  
happy



**triste**  
sad



**excité**  
excited



**ennuyé**  
bored



**surpris**  
surprised



**effrayé**  
scared



le froncement  
de sourcils  
frown

**fâché**  
angry

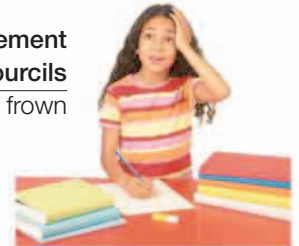

**confus**  
confused



**inquiet**  
worried



**nerveux**  
nervous



**fier**  
proud



**confiant**  
confident



**gêné**  
embarrassed



**timide**  
shy

## vocabulaire • vocabulary

<b>consterné</b> upset	<b>rire</b> laugh (v)	<b>soupirer</b> sigh (v)	<b>crier</b> shout (v)
<b>choqué</b> shocked	<b>pleurer</b> cry (v)	<b>s'évanouir</b> faint (v)	<b>bâiller</b> yawn (v)

# les événements de la vie • life events



**naître**  
be born (v)



**commencer à l'école**  
start school (v)



**se faire des amis**  
make friends (v)



**obtenir sa licence**  
graduate (v)



**trouver un emploi**  
get a job (v)



**tomber amoureux**  
fall in love (v)



**se marier**  
get married (v)



**avoir un bébé**  
have a baby (v)



**le mariage** | wedding



**le divorce**  
divorce



**l'enterrement**  
funeral

## vocabulaire • vocabulary

**le baptême**  
christening

**mourir**  
die (v)

**la bar-mitsvah**  
bar mitzvah

**faire son testament**  
make a will (v)

**l'anniversaire de mariage**  
anniversary

**l'acte de naissance**  
birth certificate

**émigrer**  
emigrate (v)

**le repas de nocés**  
wedding reception

**prendre sa retraite**  
retire (v)

**le voyage de nocés**  
honeymoon

les fêtes • celebrations

la fête  
birthday party



l'anniversaire  
birthday

la carte  
card



le cadeau  
present



le Noël  
Christmas

les fêtes • festivals



la Pâque  
Passover



le Nouvel An  
New Year



le carnaval  
carnival

le défilé  
procession



le Ramadan  
Ramadan

le ruban  
ribbon



la fête de Thanksgiving  
Thanksgiving



Pâques  
Easter



la veille de la Toussaint  
Halloween



la Diwali  
Diwali



[WWW.EBOOK777.COM](http://WWW.EBOOK777.COM)



**l'apparence**  
appearance

# les vêtements d'enfants • children's clothing

## le bébé • baby



le tricot  
de corps  
undershirt

la grenouillère  
coverall

le bouton-  
pression  
snap



le pyjama  
sleeper



la combinaison de neige  
snowsuit



la combinaison-short  
romper



le bavoir  
bib



les moufles  
mittens



les chaussons  
booties



la couche  
éponge  
cloth diaper



la couche jetable  
disposable diaper



la culotte en  
plastique  
plastic pants

## le petit enfant • toddler



le chapeau de  
soleil  
sun hat



le tablier  
apron



le bermuda  
shorts

la salopette  
overalls



le t-shirt  
T-shirt



la jupe  
skirt



**l'enfant • child**



la robe  
dress

la capuche  
hood

les sandales  
sandals

**l'été**  
summer



**l'imperméable**  
raincoat



le jean  
jeans

**l'automne**  
fall

le sac à dos  
backpack

le bouton  
toggle



**le duffel-coat**  
duffle coat



l'écharpe  
scarf

l'anorak  
parka

les bottes de caoutchouc  
wellington boots

**l'hiver**  
winter



la robe de chambre  
bathrobe

le logo  
logo

les baskets  
athletic shoes

la chemise de nuit  
nightgown

les pantoufles  
slippers

**les vêtements de nuit**  
nightwear



**la tenue de foot**  
soccer uniform



**le survêtement**  
jogging suit



**les leggings**  
leggings

**vocabulaire • vocabulary**

la fibre naturelle  
natural fiber

synthétique  
synthetic

C'est lavable en machine?  
Is it machine washable?

C'est la bonne taille pour deux ans?  
Will this fit a two-year-old?

# les vêtements pour hommes • men's clothing



le col  
collar

la cravate  
tie

la ceinture  
belt

le revers  
lapel

la boutonnière  
buttonhole

la manchette  
cuff

la poche  
pocket

la veste  
jacket

le bouton  
button

le pantalon  
pants

le costume  
business suit

l'imperméable  
raincoat

la doublure  
lining

les  
chaussures  
en cuir  
leather  
shoes

## vocabulaire • vocabulary

le cardigan  
cardigan

les sous-vêtements  
underwear

le manteau  
coat

court  
short

le peignoir  
dressing gown

le survêtement  
jogging suit

long  
long

Avez-vous ça en plus grand/petit?  
Do you have this in a larger/smaller  
size?

Je peux l'essayer?  
May I try this on?



**le blazer**  
blazer



**la veste de sport**  
sportcoat



**le gilet**  
waistcoat

**l'encolure en V**  
V-neck

**le col rond**  
round neck



**le t-shirt**  
T-shirt



**l'anorak**  
parka



**le sweat-shirt**  
sweatshirt



**la chemise**  
shirt

**le jean**  
jeans



**le pullover**  
sweater



**le pyjama**  
pajamas



**le tricot de corps**  
vest

**les vêtements sport**  
casual wear



**le short**  
shorts



**le slip**  
briefs



**le caleçon**  
boxer shorts



**les chaussettes**  
socks

# les vêtements pour femmes • women's clothing



## la lingerie • lingerie



**le peignoir**  
robe



**le caraco**  
slip

**la bretelle**  
strap



**la camisole**  
camisole



**la guêpière**  
bustier

**la jarretelle**  
garter



**le bas**  
stocking



**le collant**  
pantyhose



**le soutien-gorge**  
bra



**le slip**  
panties



**la chemise de nuit**  
nightgown

## le mariage • wedding



**le voile**  
veil

**la dentelle**  
lace

**le bouquet**  
bouquet

**la traîne**  
train

**la robe de mariée**  
wedding dress

## vocabulaire • vocabulary

**le corset**  
corset

**ajusté**  
tailored

**la jarretière**  
garter

**dos-nu**  
halter neck

**l'épaulette**  
shoulder pad

**à armature**  
underwired

**la ceinture**  
waistband

**le soutien-gorge sport**  
sports bra

## les accessoires • accessories



la casquette  
cap



le chapeau  
hat



le foulard  
scarf



la boucle  
buckle

la ceinture  
belt

le manche  
handle



la pointe  
tip

le parapluie  
umbrella



le mouchoir  
handkerchief



le nœud papillon  
bow tie



l'épingle de  
cravate  
tie-pin



les gants  
gloves

## les bijoux • jewellery



le pendentif  
pendant



la broche  
brooch



le bouton de manchette  
cufflink

le rang de perles  
string of pearls

le maillon  
link



le bracelet  
bracelet

le fermoir  
clasp



la chaîne  
chain

la boucle d'oreille  
earring

la bague  
ring

la pierre  
stone

le collier  
necklace

la montre  
watch



la boîte à bijoux | jewelry box

les sacs • bags



le portefeuille  
wallet



le porte-monnaie  
purse



le sac à  
bandoulière  
shoulder bag

le fermoir  
fastening

la bretelle  
shoulder strap

les poignées  
handles



le fourre-tout  
duffle bag



la serviette  
briefcase



le sac à main  
handbag



le sac à dos  
backpack

les chaussures • shoes

le lacet  
lace

la languette  
tongue

l'œillet  
eyelet

la semelle  
sole



la chaussure lacée  
lace-up

le talon  
heel



la botte  
boot



le pataugas  
walking boot



la basket  
athletic shoe



la tong  
flip-flop



la chaussure de cuir  
leather shoe



la chaussure à  
talon  
high-heeled shoe



la chaussure  
compensée  
wedge



la sandale  
sandal



le mocassin  
slip-on



la ballerine  
pump

# les cheveux • hair



le peigne  
comb

peigner  
comb (v)



la brosse  
brush

brosser | brush (v)



rincer  
rinse (v)



la coiffeuse  
hairdresser

le lavabo  
sink

la cliente  
client

laver | wash (v)



le peignoir  
robe

couper  
cut (v)



sécher  
blow-dry (v)



faire une mise en plis  
set (v)

# les accessoires • accessories



le sèche-cheveux  
hairdryer



le shampoing  
shampoo



l'après-shampoing  
conditioner



le gel  
gel



la laque  
hairspray



les ciseaux  
scissors



le serre-tête  
hairband



le fer à lisser  
hair straighteners



la pince à cheveux  
hairpin



## les coiffures • styles



la queue de cheval  
ponytail



la natte  
braid



le rouleau  
French braid



le chignon  
bun



les couettes  
pigtails



au carré  
bob



la coupe courte  
crop



frisé  
curly



la permanente  
perm



raide  
straight

les racines  
roots



les reflets  
highlights



chauve  
bald



la perruque  
wig

## les couleurs • colors



blond  
blonde



châtain  
brunette



auburn  
auburn



roux  
red



noir  
black



gris  
gray



blanc  
white



teint  
dyed

vocabulaire • vocabulary

rafraîchir  
trim (v)

gras  
greasy

décrêper  
straighten (v)

sec  
dry

le coiffeur  
barber

normal  
normal

les pellicules  
dandruff

le cuir chevelu  
scalp

les fourches  
split ends

l'élastique pour  
cheveux  
hairband

# la beauté • beauty



la teinture de cheveux  
hair dye

le fard à  
paupières  
eye shadow

le mascara  
mascara

l'eye-liner  
eyeliner

le fard à joues  
blusher

le fond de teint  
foundation

le rouge à lèvres  
lipstick

## le maquillage • makeup



le crayon à sourcils  
eyebrow pencil



la brosse à sourcils  
eyebrow brush



la pince à épiler  
tweezers



le brillant à lèvres  
lip gloss



le pinceau à lèvres  
lip brush



le crayon à lèvres  
lip liner



le pinceau  
brush



le correcteur  
concealer

le miroir  
mirror

la poudre  
face powder

la houppette  
powder puff



le poudrier | compact

**les soins de beauté • beauty treatments**

le masque de beauté  
face mask



le soin du visage  
facial



le lit U.V.  
sunbed



exfolier  
exfoliate (v)



l'épilation  
wax



la pédicurie  
pedicure

**la manucure • manicure**



la lime à ongles  
nail file

le dissolvant  
nail polish remover



le vernis à ongles  
nail polish

les ciseaux à ongles  
nail scissors



le coupe-ongles  
nail clippers



**les accessoires de toilette • toiletries**



le démaquillant  
cleanser



le tonique  
toner



la crème hydratante  
moisturizer



l'autobronzant  
self-tanning cream



le parfum  
perfume



l'eau de toilette  
cologne

**vocabulaire • vocabulary**

le teint complexion	gras oily	le bronzage tan
clair fair	sensible sensitive	le tatouage tattoo
foncé dark	hypoallergénique hypoallergenic	antirides anti-wrinkle
sec dry	le ton shade	les boules de coton cotton balls



[WWW.EBOOK777.COM](http://WWW.EBOOK777.COM)



la santé  
health



[WWW.EBOOK777.COM](http://WWW.EBOOK777.COM)

# la maladie • illness



la fièvre | fever

l'inhalateur  
inhaler



l'asthme  
asthma



les crampes  
cramps



le mal de tête  
headache



l'éternuement  
sneeze



le saignement de  
nez  
nosebleed



la toux  
cough



le rhume  
cold



la grippe  
flu



la nausée  
nausea



la varicelle  
chickenpox



l'éruption  
rash

## vocabulaire • vocabulary

l'attaque  
stroke

le diabète  
diabetes

l'eczéma  
eczema

le refroidissement  
chill

vomir  
vomit (v)

la diarrhée  
diarrhea

la tension  
blood pressure

l'allergie  
allergy

l'infection  
infection

le mal d'estomac  
stomachache

l'épilepsie  
epilepsy

la rougeole  
measles

la crise  
cardiaque  
heart attack

le rhume  
des foins  
hayfever

le virus  
virus

s'évanouir  
faint (v)

la migraine  
migraine

les  
oreillons  
mumps

**le médecin • doctor**  
**la consultation • consultation**

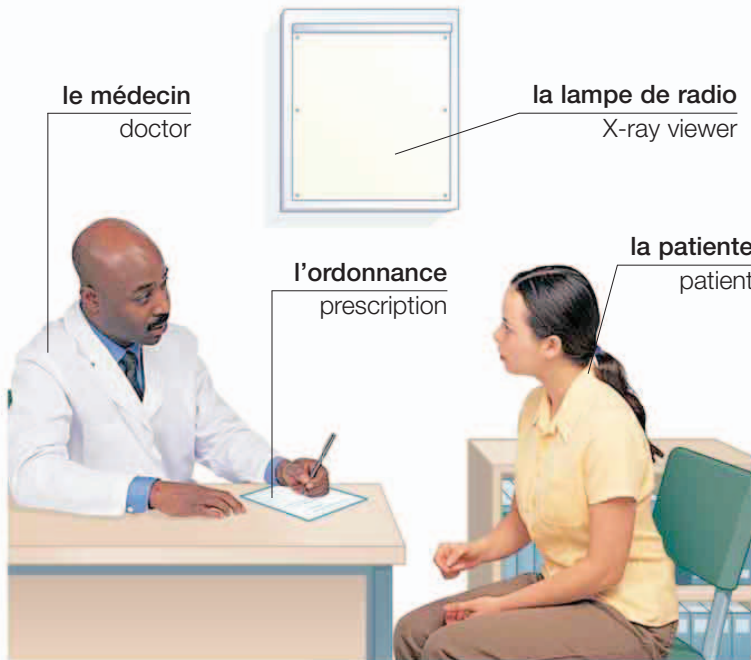

**l'infirmière**  
nurse

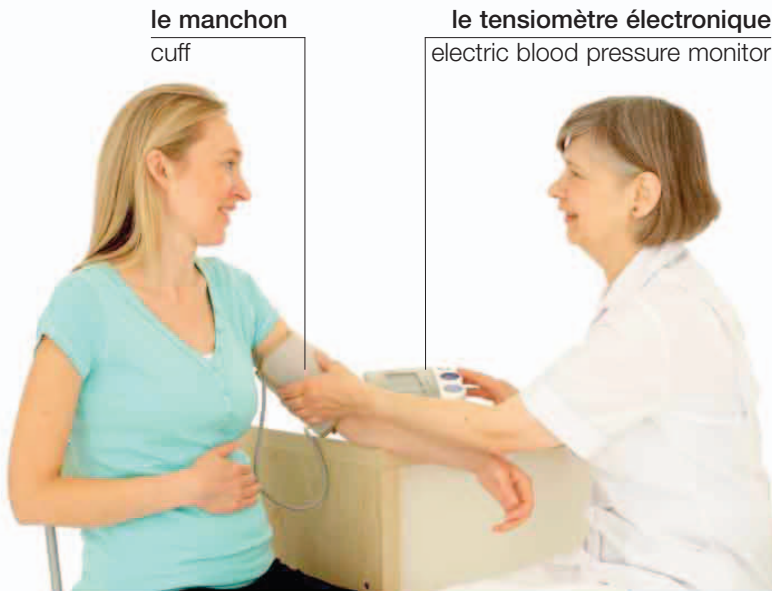

**vocabulaire • vocabulary**

**le rendez-vous**  
appointment

**l'inoculation**  
vaccination

**le cabinet**  
surgery

**le thermomètre**  
thermometer

**la salle  
d'attente**  
waiting room

**l'examen  
médical**  
medical  
examination

**J'ai besoin de voir un médecin.**  
I need to see a doctor.

**J'ai mal ici.**  
It hurts here.

# la blessure • injury



**l'entorse** | sprain

**l'écharpe**  
sling



**la fracture**  
fracture

**la minerve**  
neck brace



**le coup du lapin**  
whiplash



**la coupure**  
cut



**l'écorchure**  
graze



**la contusion**  
bruise



**l'écharde**  
splinter



**le coup de soleil**  
sunburn



**la brûlure**  
burn



**la morsure**  
bite



**la piqûre**  
sting

## vocabulaire • vocabulary

**l'accident**  
accident

**l'hémorragie**  
hemorrhage

**l'empoisonnement**  
poisoning

**Est-ce qu'il/elle va se remettre?**  
Will he/she be all right?

**l'urgence**  
emergency

**l'ampoule**  
blister

**le choc électrique**  
electric shock

**Où avez-vous mal?**  
Where does it hurt?

**la blessure**  
wound

**la commotion  
cérébrale**  
concussion

**le traumatisme  
crânien**  
head injury

**Appelez une ambulance s'il  
vous plaît.**  
Please call an ambulance.



# les premiers secours • first aid

la pommade  
ointment

le pansement  
bandage

l'épingle de  
sûreté  
safety pin

le bandage  
bandage

les analgésiques  
painkillers



la serviette  
antiseptique  
antiseptic wipe

la pince fine  
tweezers

les ciseaux  
scissors

l'antiseptique  
antiseptic

la trousse de premiers secours | first-aid box

la gaze  
gauze



le pansement  
dressing



l'attelle  
splint



le sparadrap  
adhesive tape



la réanimation  
resuscitation

## vocabulaire • vocabulary

le choc  
shock

le pouls  
pulse

étouffer  
choke (v)

Est-ce que vous pouvez  
m'aider?

Can you help?

sans  
connaissance  
unconscious

la  
respiration  
breathing

stérile  
sterile

Pouvez-vous donner les  
soins d'urgence?

Do you know first aid?

# l'hôpital • hospital



**l'analyse de sang**  
blood test



**l'injection**  
injection



**la radio**  
X-ray



**la salle des urgences**  
emergency room



**la salle**  
ward



**la chaise roulante**  
wheelchair

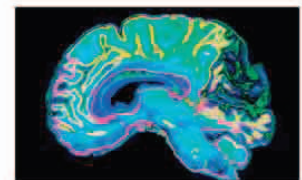

**la scanographie**  
scan

## vocabulaire • vocabulary

**l'opération**  
operation

**renvoyé**  
discharged

**les heures de visite**  
visiting hours

**la pédiatrie**  
children's ward

**le service de soins intensifs**  
intensive care unit

**admis**  
admitted

**la clinique**  
clinic

**la maternité**  
maternity ward

**la chambre privée**  
private room

**le malade en consultation externe**  
outpatient

les services • departments



**l'O.R.L.**  
ENT (otolaryngology)



**la cardiologie**  
cardiology



**l'orthopédie**  
orthopedics



**la gynécologie**  
gynecology



**la kinésithérapie**  
physiotherapy



**la dermatologie**  
dermatology



**la pédiatrie**  
pediatrics



**la radiologie**  
radiology



**la chirurgie**  
surgery



**la maternité**  
maternity



**la psychiatrie**  
psychiatry



**l'ophtalmologie**  
ophthalmology

**vocabulaire** • vocabulary

**la neurologie**  
neurology

**l'urologie**  
urology

**l'endocrinologie**  
endocrinology

**la pathologie**  
pathology

**le résultat**  
result

**l'oncologie**  
oncology

**la chirurgie  
esthétique**  
plastic surgery

**l'orientation  
d'un patient**  
referral

**l'analyse**  
test

**le spécialiste**  
consultant

# le dentiste • dentist

## la dent • tooth

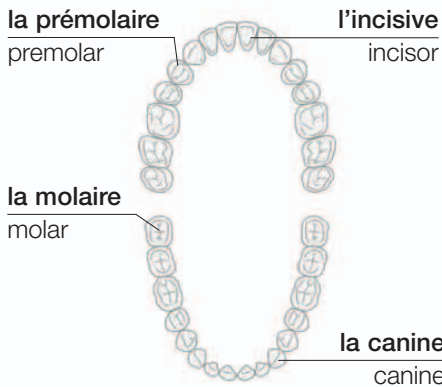
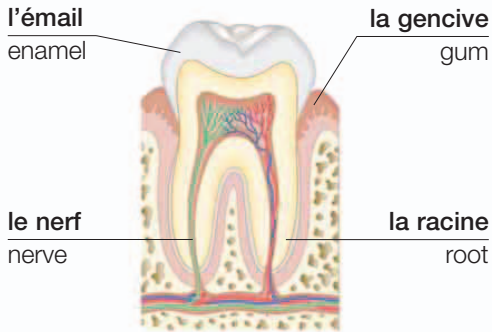

## la visite de contrôle • checkup

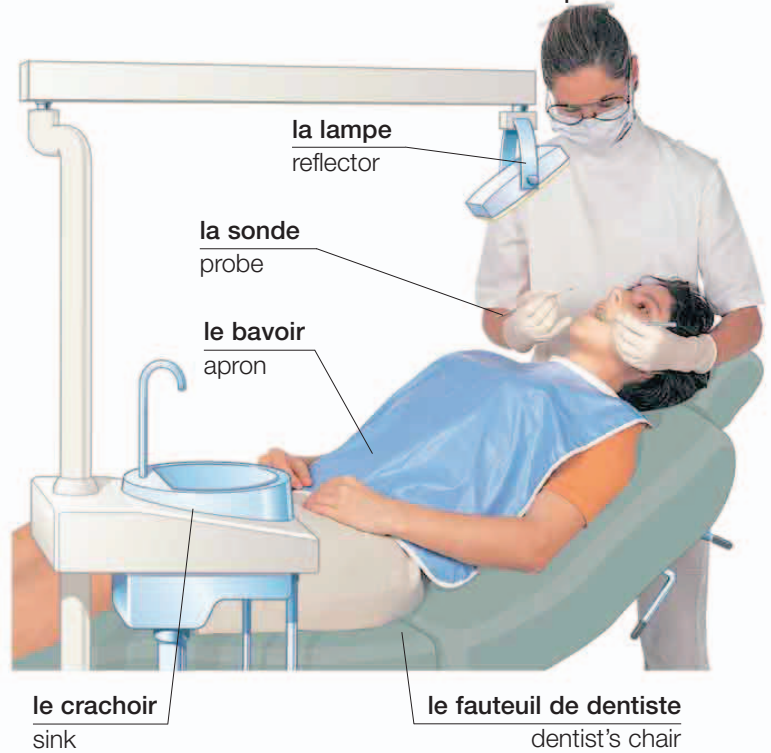

### vocabulaire • vocabulary

la rage de dents  
toothache

la fraise  
drill

la plaque  
plaque

le fil dentaire  
dental floss

la carie  
decay

l'extraction  
extraction

le plombage  
filling

la couronne  
crown



utiliser le fil dentaire  
floss (v)



brosser  
brush



l'appareil dentaire  
braces



la radio dentaire  
dental X-ray



la radio  
X-ray film



le dentier  
dentures

# l'opticien • optometrist



l'examen de la vue | eye test

l'étui  
case



les lunettes  
glasses

le verre  
lens



les lunettes de soleil  
sunglasses

la monture  
frame

la solution nettoyante  
cleaning fluid



la solution  
désinfectante  
disinfectant solution



l'étui à lentilles  
lens case

les lentilles de contact | contact lenses

## l'œil • eye

le sourcil  
eyebrow

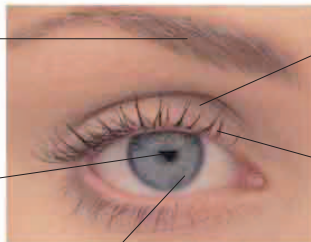

la paupière  
eyelid

la pupille  
pupil

le cil  
eyelash

l'iris  
iris

le cristallin  
lens

la rétine  
retina

la cornée  
cornea

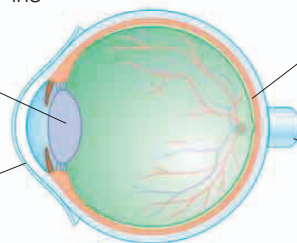

le nerf optique  
optic nerve

## vocabulaire • vocabulary

la vue  
vision

l'astigmatisme  
astigmatism

la dioptrie  
diopter

la presbytie  
farsightedness

la larme  
tear

la myopie  
nearsightedness

la cataracte  
cataract

bifocal  
bifocal

# la grossesse • pregnancy



**le test de grossesse**  
pregnancy test

**l'échographie**  
scan



**les ultrasons** | ultrasound

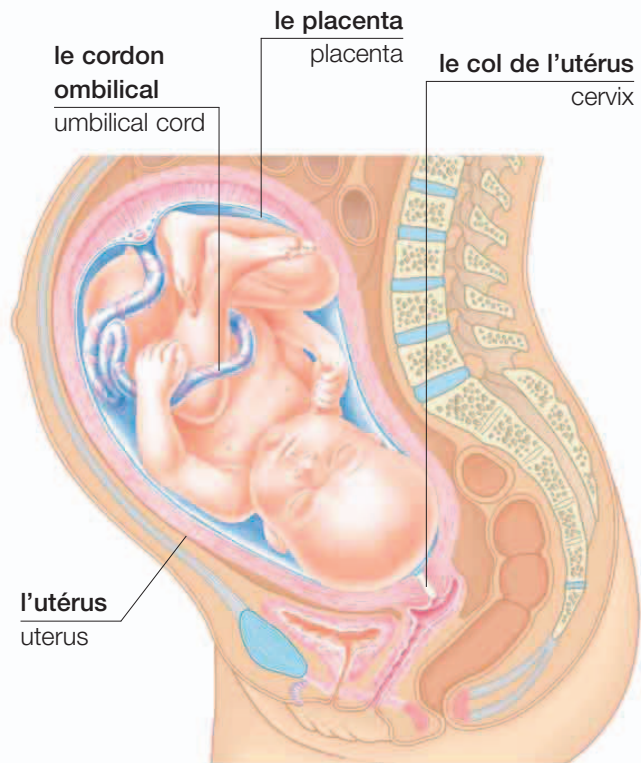

**le cordon ombilical**  
umbilical cord

**le placenta**  
placenta

**le col de l'utérus**  
cervix

**l'utérus**  
uterus

**le fœtus** | fetus

## vocabulaire • vocabulary

<b>l'ovulation</b> ovulation	<b>prénatal</b> prenatal	<b>l'amniocentèse</b> amniocentesis	<b>la dilatation</b> dilation	<b>l'accouchement</b> delivery	<b>par le siège</b> breach
<b>la conception</b> conception	<b>l'embryon</b> embryo	<b>la contraction</b> contraction	<b>la péridurale</b> epidural	<b>la naissance</b> birth	<b>prématuré</b> premature
<b>enceinte</b> pregnant	<b>l'utérus</b> womb	<b>perdre les eaux</b> break water (v)	<b>l'épisiotomie</b> episiotomy	<b>la fausse couche</b> miscarriage	<b>le gynécologue</b> gynecologist
<b>enceinte</b> expecting	<b>le trimestre</b> trimester	<b>le liquide amniotique</b> amniotic fluid	<b>la césarienne</b> cesarean section	<b>les points de suture</b> stitches	<b>l'obstétricien</b> obstetrician

# la naissance • childbirth

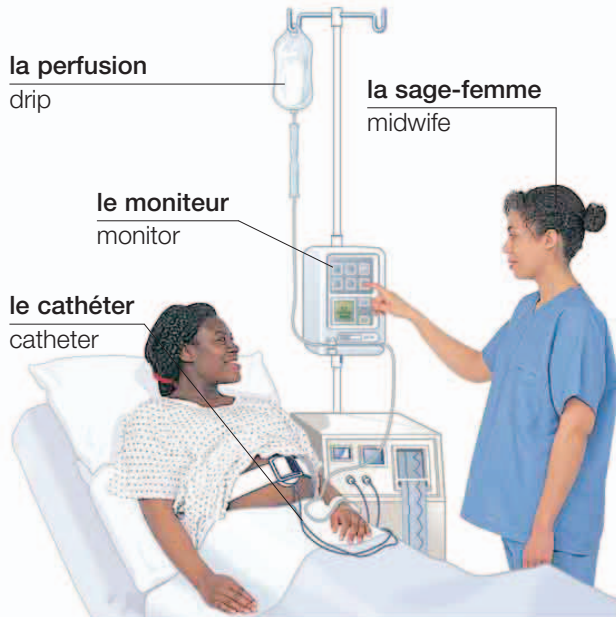

la perfusion  
drip

la sage-femme  
midwife

le moniteur  
monitor

le cathéter  
catheter

déclencher l'accouchement  
induce labor (v)



la conveuse | incubator



le poids de naissance  
birth weight

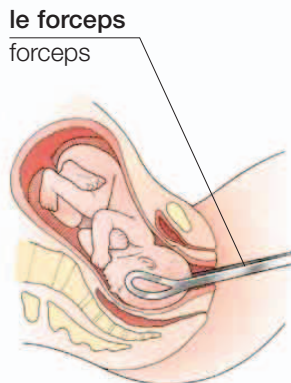

le forceps  
forceps

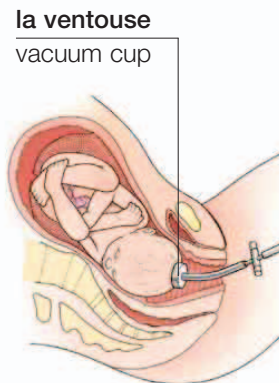

la ventouse  
vacuum cup

l'accouchement assisté  
assisted delivery

le bracelet d'identité  
identity tag



le nouveau-né  
newborn baby

## l'allaitement • nursing



la pompe à lait  
breast pump



le soutien-gorge  
d'allaitement  
nursing bra



donner le sein  
breastfeed (v)



les coussinets  
pads

# les thérapies alternatives • complementary therapy



le yoga | yoga



le massage  
massage



le shiatsu  
shiatsu



la chiropractie  
chiropractic



l'ostéopathie  
osteopathy



la réflexologie  
reflexology



la méditation  
meditation



le conseiller  
counselor



la thérapie de groupe  
group therapy



le reiki  
reiki



l'acupuncture  
acupuncture



la médecine ayurvédique  
ayurveda



l'hypnothérapie  
hypnotherapy

les huiles essentielles  
essential oils



l'herboristerie  
herbalism



l'aromathérapie  
aromatherapy



l'homéopathie  
homeopathy



l'acupression  
acupressure

la thérapeute  
therapist



la psychothérapie  
psychotherapy

**vocabulaire** • vocabulary

le supplément  
supplement

la naturopathie  
naturopathy

la relaxation  
relaxation

l'herbe  
herb

l'hydrothérapie  
hydrotherapy

le feng shui  
feng shui

le stress  
stress

la guérison  
par cristaux  
crystal healing





la maison  
home

[WWW.EBOOK777.COM](http://WWW.EBOOK777.COM)

# la maison • house

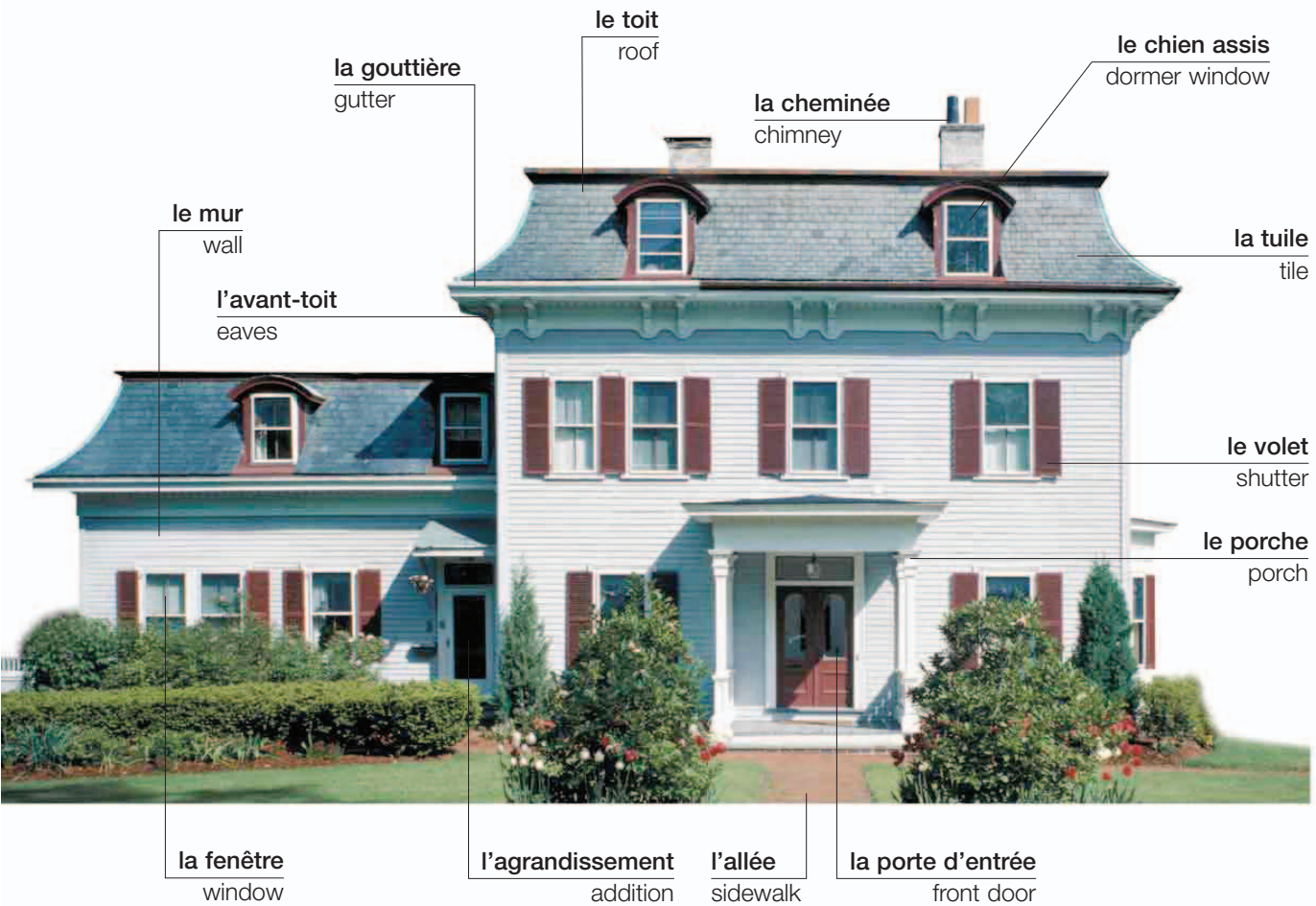

## vocabulaire • vocabulary

<b>individuelle</b> single-family	<b>le locataire</b> tenant	<b>le garage</b> garage	<b>la boîte aux lettres</b> mailbox	<b>l'alarme</b> burglar alarm	<b>louer</b> rent (v)
<b>mitoyenne</b> duplex	<b>la pavillon</b> ranch house	<b>le grenier</b> attic	<b>la lampe d'entrée</b> porch light	<b>la cour</b> courtyard	<b>le loyer</b> rent
<b>la maison de deux étages</b> townhouse	<b>le sous-sol</b> basement	<b>la chambre</b> room	<b>le propriétaire</b> landlord	<b>l'étage</b> floor	<b>attenante</b> terraced

**l'entrée • entrance**

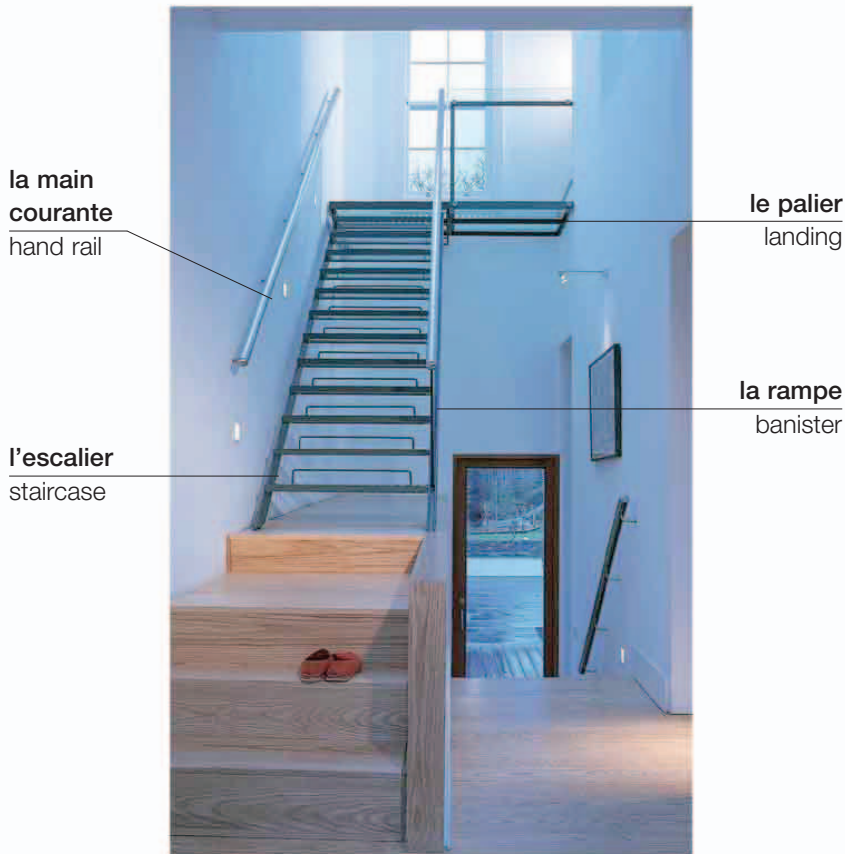

**la main courante**  
hand rail

**l'escalier**  
staircase

**le palier**  
landing

**la rampe**  
banister

**le vestibule**  
foyer



**la sonnette**  
doorbell



**le paillason**  
doormat



**le marteau de porte**  
door knocker



**la chaîne de sûreté**  
door chain

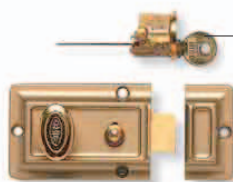

**la serrure**  
lock



**le verrou**  
bolt

**la clef**  
key

**l'appartement • apartment**



**le balcon**  
balcony

**l'immeuble**  
apartment building



**l'interphone**  
intercom



**l'ascenseur**  
elevator

# les systèmes domestiques • internal systems



**le radiateur**  
radiator



**l'appareil de chauffage**  
space heater



**le ventilateur**  
fan



**le convecteur**  
convector heater

## l'électricité • electricity



**le filament**  
filament

**la mise à la terre**  
ground

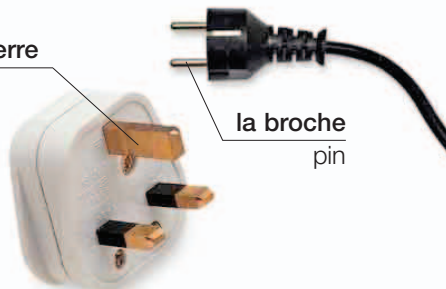

**la prise**  
plug

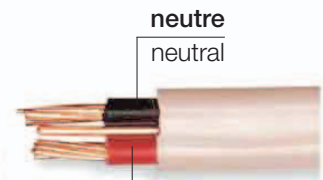

**neutre**  
neutral

**sous tension**  
live

**l'ampoule basse consommation**  
energy-saving bulb

**les fils**  
wires

## vocabulaire • vocabulary

**la tension**  
voltage

**le fusible**  
fuse

**la prise de courant**  
outlet

**le courant continu**  
direct current

**la coupure de courant**  
power outage

**l'ampère**  
amp

**la boîte à fusibles**  
fuse box

**l'interrupteur**  
switch

**le transformateur**  
transformer

**le réseau d'électricité**  
household current

**le courant**  
power

**la génératrice**  
generator

**le courant alternatif**  
alternating current

**le compteur d'électricité**  
electric meter

# la plomberie • plumbing

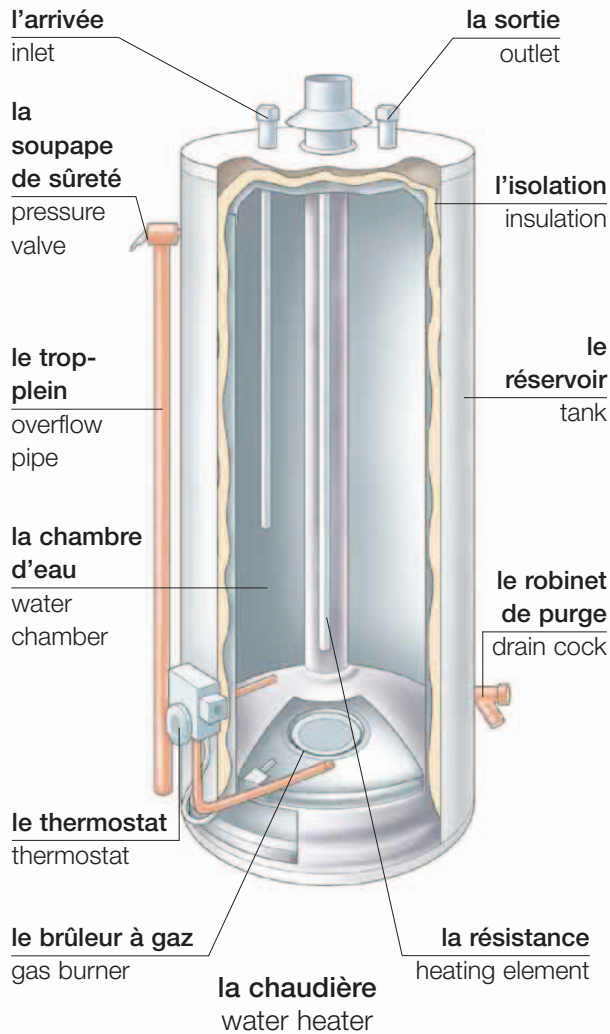

## l'évier • sink

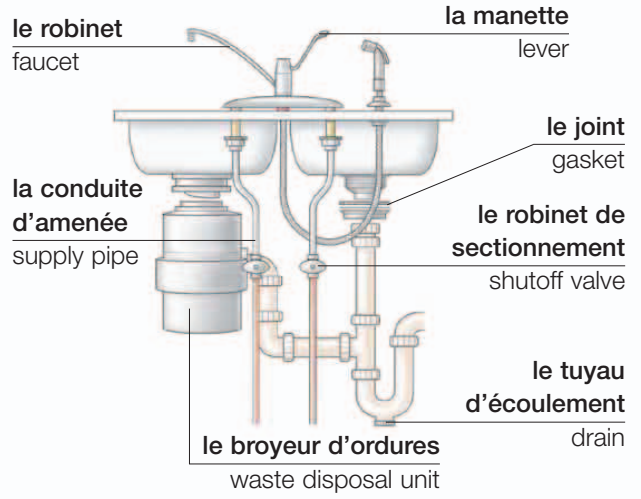

## les W.-C. • toilet

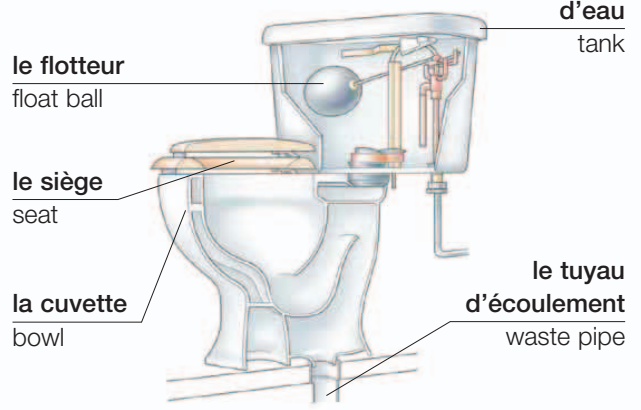

## l'enlèvement de déchets • waste disposal

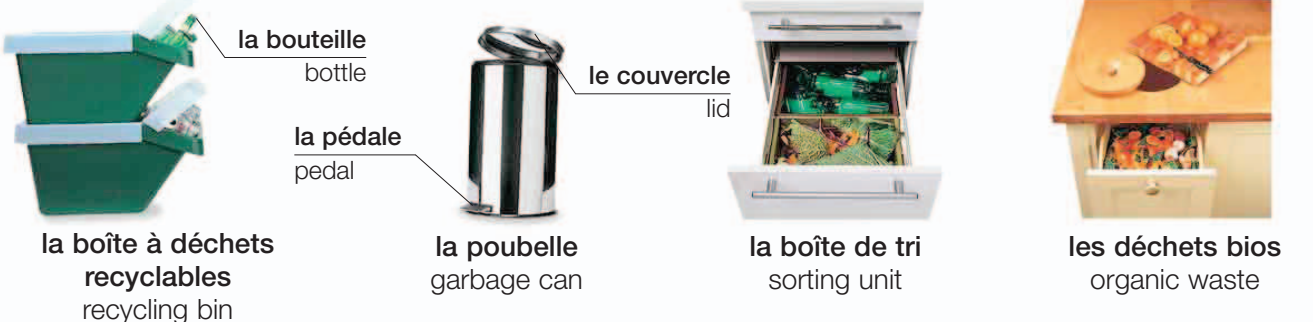

# le salon • living room

**le plafond**  
ceiling

**le vase**  
vase

**le coussin**  
cushion

**la lampe**  
lamp

**la table basse**  
coffee table

**le canapé**  
sofa

**le sol**  
floor

**l'applique**  
wall light

**la cheminée**  
fireplace





le cadre  
frame



le tableau  
painting

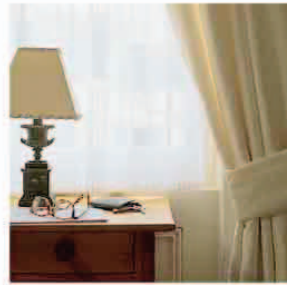

le rideau  
curtain



le brise-bise  
net curtain



le store vénitien  
venetian blind



le store  
shade

la moulure  
molding

le fauteuil  
armchair

la bibliothèque  
bookshelf

le canapé-lit  
sofabed

le tapis  
rug

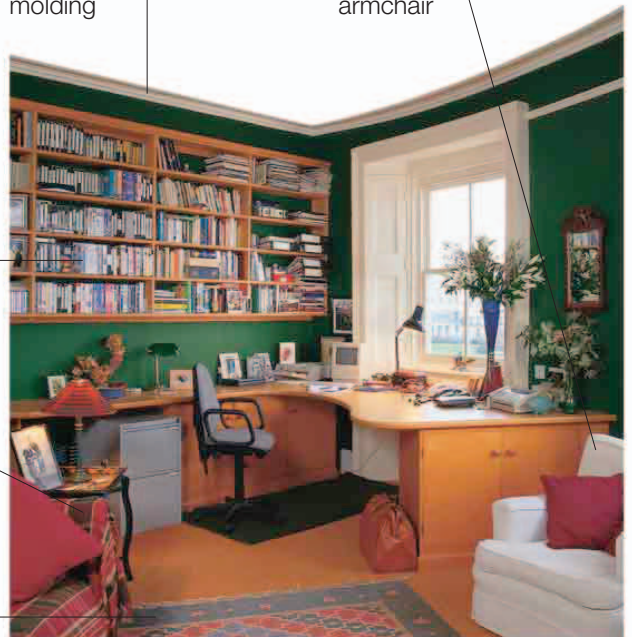

le bureau | study

# la salle à manger • dining room



## vocabulaire • vocabulary

**mettre la table**  
set the table (v)

**(avoir) faim**  
hungry

**le déjeuner**  
lunch

**rassasié**  
full

**l'hôte**  
host

**Puis-je en reprendre un peu, s'il vous plaît?**

Can I have some more, please?

**servir**  
serve (v)

**la nappe**  
tablecloth

**le dîner**  
dinner

**la portion**  
portion

**l'hôtesse**  
hostess

**Non merci, j'en ai eu assez.**

I've had enough, thank you.

**manger**  
eat (v)

**le petit déjeuner**  
breakfast

**le set de table**  
placemat

**le repas**  
meal

**l'invité**  
guest

**C'était délicieux.**

That was delicious.

la vaisselle et les couverts • crockery and cutlery



la grande tasse  
mug



la tasse à thé  
teacup



la tasse à café  
coffee cup

la cuiller à café  
teaspoon



l'assiette  
plate



le bol  
bowl



la cafetière  
cafetière



la théière  
teapot



le pot  
pitcher



le coquetier  
egg cup

le verre à vin  
wine glass



le verre  
tumbler



la verrerie  
glassware

le rond de  
serviette  
napkin ring

l'assiette à  
dessert  
side plate

l'assiette  
plate  
dinner plate

l'assiette à  
soupe  
soup bowl

la cuiller à soupe  
soup spoon



la serviette  
napkin



la fourchette  
fork



le couvert  
place setting



la cuiller  
spoon

le couteau  
knife

# la cuisine • kitchen



## les appareils ménagers • appliances

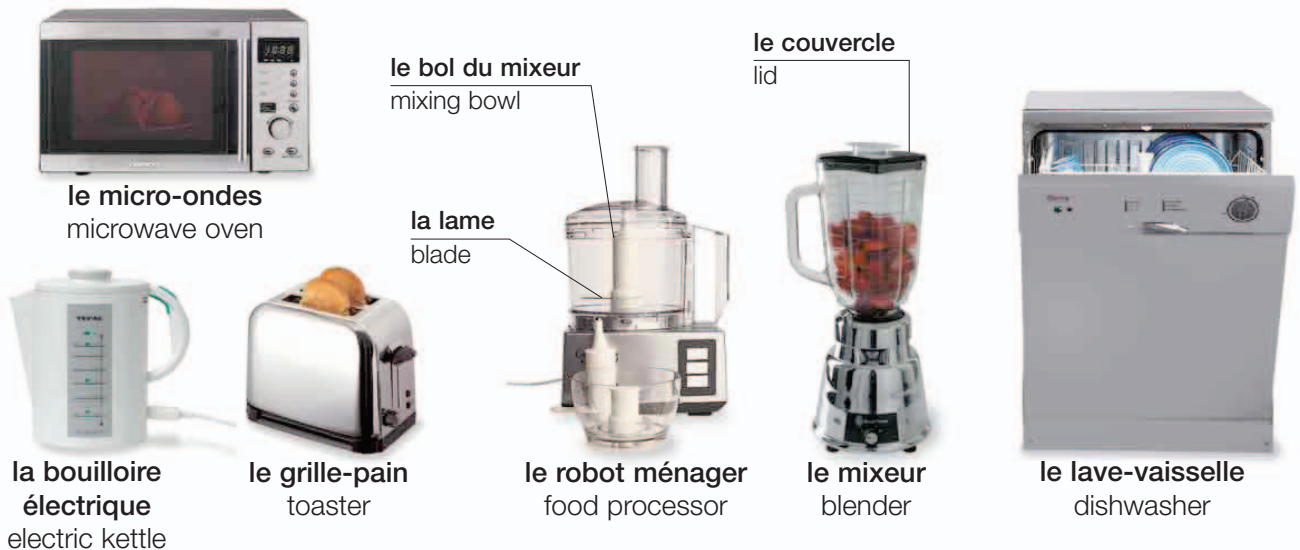

**le freezer**  
ice maker

**le congélateur**  
freezer



**la clayette**  
shelf

**le bac à légumes**  
crisper

**le réfrigérateur** | refrigerator

**vocabulaire** • vocabulary

**l'égouttoir**  
draining board

**congeler**  
freeze (v)

**le brûleur**  
burner

**décongeler**  
defrost (v)

**la table de cuisson**  
stovetop

**cuire à la vapeur**  
steam (v)

**la poubelle**  
garbage can

**faire sauter**  
sauté (v)

**la cuisine** • cooking



**éplucher**  
peel (v)



**couper**  
slice (v)



**râper**  
grate (v)



**verser**  
pour (v)



**mélanger**  
mix (v)



**battre**  
whisk (v)



**bouillir**  
boil (v)



**frir**  
fry (v)



**étaler au rouleau**  
roll (v)



**remuer**  
stir (v)



**mijoter**  
simmer (v)



**pocher**  
poach (v)



**cuire au four**  
bake (v)



**rôtir**  
roast (v)



**griller**  
broil (v)

# les ustensiles de cuisine • kitchenware



**la planche à hacher**  
cutting board

**le couteau à pain**  
bread knife



**le couteau de cuisine**  
kitchen knife



**le fendoir**  
cleaver



**l'aiguisoir**  
knife sharpener



**l'attendrisseur**  
meat tenderizer



**la broche**  
skewer



**la râpe**  
grater



**le pilon**  
pestle



**le presse-purée**  
potato masher



**l'épluche-légume**  
vegetable peeler



**le vide-pomme**  
apple corer



**l'ouvre-boîte**  
can opener



**l'ouvre-bouteille**  
bottle opener



**le presse-ail**  
garlic press



**la cuiller à servir**  
serving spoon



**la pelle à poisson**  
slotted spatula



**la passoire**  
colander



**la spatule**  
spatula



**la cuiller en bois**  
wooden spoon



**l'écumoire**  
slotted spoon



**la louche**  
ladle



**la fourchette à découper**  
carving fork



**la cuiller à glace**  
ice-cream scoop



**le fouet**  
whisk



**la passoire**  
sieve



la pâtisserie • baking cakes



# la chambre • bedroom

**l'armoire**  
wardrobe

**la lampe de chevet**  
bedside lamp

**la tête de lit**  
headboard

**la table de nuit**  
nightstand

**la commode**  
chest of drawers



**le tiroir**  
drawer

**le lit**  
bed

**le matelas**  
mattress

**le couvre-lit**  
bedspread

**l'oreiller**  
pillow



**la bouillotte**  
hot-water bottle



**le radio-réveil**  
clock radio



**le réveil**  
alarm clock



**la boîte de kleenex**  
box of tissues



**le cintre**  
coathanger



le linge de lit • bed linen



le miroir  
mirror

la coiffeuse  
dressing  
table

le sol  
floor



la taie d'oreiller  
pillowcase

le drap  
sheet

la frange de lit  
dust ruffle

la couette  
comforter

l'édredon  
quilt

la  
couverture  
blanket



vocabulaire • vocabulary

le lit simple  
twin bed

le pied de lit  
footboard

l'insomnie  
insomnia

se réveiller  
wake up (v)

mettre le réveil  
set the alarm (v)

le grand lit  
full bed

le ressort  
spring

se coucher  
go to bed (v)

se lever  
get up (v)

ronfler  
snore (v)

la couverture  
chauffante  
electric blanket

le tapis  
carpet

s'endormir  
go to sleep (v)

faire le lit  
make the bed (v)

l'armoire  
encastrée  
built-in wardrobe

# la salle de bain • bathroom

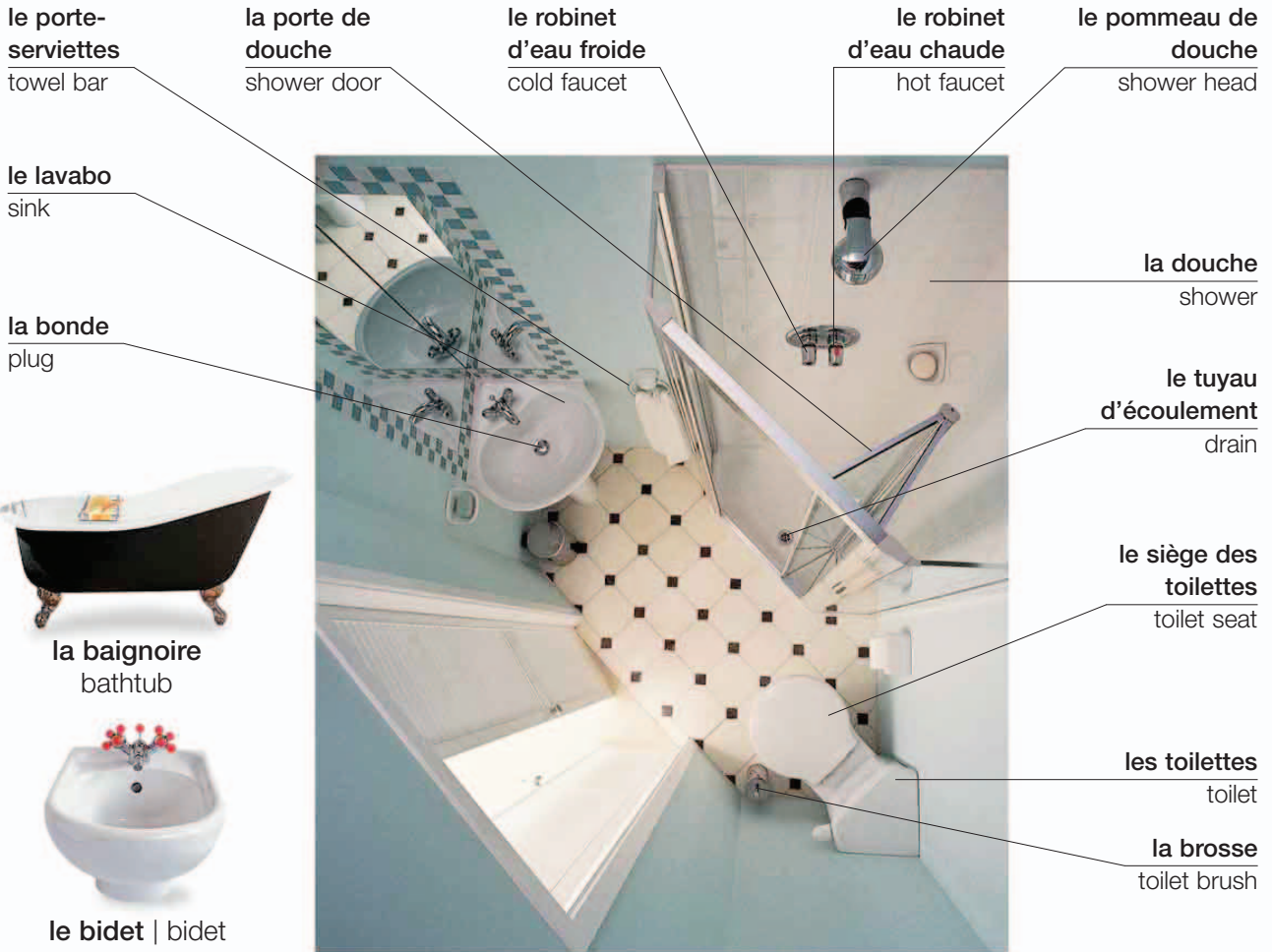

## vocabulaire • vocabulary

**l'armoire à pharmacie**  
medicine cabinet

**le tapis de bain**  
bath mat

**le rouleau de papier hygiénique**  
toilet paper

**le rideau de douche**  
shower curtain

**prendre une douche**  
take a shower (v)

**prendre un bain**  
take a bath (v)

## l'hygiène dentaire • dental hygiene



**la brosse à dents**  
toothbrush



**le fil dentaire**  
dental floss



**le dentifrice**  
toothpaste



**l'eau dentifrice**  
mouthwash

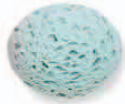

**l'éponge**  
sponge



**la pierre ponce**  
pumice stone



**la brosse pour le dos**  
back brush



**le déodorant**  
deodorant

**le porte-savon**  
soap dish



**le savon**  
soap

**le gel douche**  
shower gel



**la crème pour le visage**  
moisturizer



**le bain moussant**  
bubble bath



**le peignoir**  
bathrobe

**la serviette**  
hand towel



**les serviettes**  
towels

**la serviette de bain**  
bath towel



**la lotion pour le corps**  
body lotion



**le talc**  
talcum powder

## le rasage • shaving



**le rasoir électrique**  
electric razor



**la mousse à raser**  
shaving foam



**le rasoir jetable**  
disposable razor



**la lame de rasoir**  
razor blade



**l'after-shave**  
aftershave

# la chambre d'enfants • baby's room

## les soins de bébé • baby care



l'éponge  
sponge

la crème pour  
l'érythème  
diaper rash cream

la lingette  
wet wipe

la baignoire en plastique  
baby bath



le pot  
potty



le matelas à langer  
changing mat

## le coucher • sleeping



le mobile  
mobile

les barreaux  
bars

la couverture  
laineuse  
fleece

le protège-barreaux  
bumper

le matelas  
mattress

le lit d'enfant | crib

le drap  
sheet

la couverture  
blanket

la literie  
bedding



le hochet  
rattle



le moïse  
bassinet

**le jeu • playing**



**la sécurité • safety**

la serrure de sécurité  
child lock

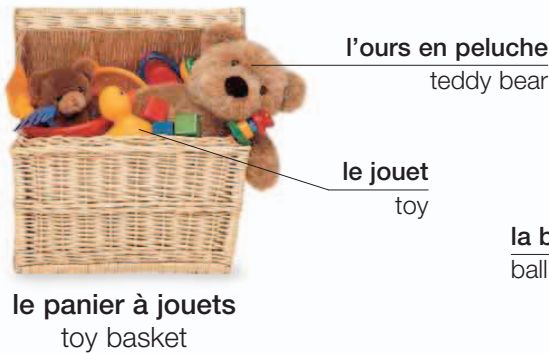

**le manger • eating**



**la sortie • going out**



# la buanderie • utility room

## le linge • laundry

**le linge sale**  
dirty laundry



**le panier à linge**  
laundry basket



**le lave-linge**  
washing machine



**le lave-linge séchant**  
washer-dryer



**le sèche-linge**  
tumble-dryer

**le linge propre**  
clean clothes



**le panier à linge**  
linen basket

**la pince à linge**  
clothespin



**sécher**  
dry (v)

**la corde à linge**  
clothesline



**la planche à repasser** | ironing board



**le fer à repasser**  
iron

### vocabulaire • vocabulary

**charger**  
load (v)

**essorer**  
spin (v)

**repasser**  
iron (v)

**Comment fonctionne le lave-linge?**  
How do I operate the washing machine?

**rincer**  
rinse (v)

**l'essoreuse**  
spin-dryer

**l'assouplisseur**  
fabric softener

**Quel est le programme pour les couleurs/le blanc?**  
What is the setting for colors/whites?

**l'équipement d'entretien • cleaning equipment**



**les activités • activities**



# l'atelier • workshop



la scie sauteuse  
jigsaw



la pile  
battery pack

la perceuse rechargeable  
cordless drill



le mandrin  
chuck

la perceuse électrique  
electric drill



la mèche  
drill bit



le pistolet à colle  
glue gun



l'étau  
vise

le serre-joint  
clamp



la ponceuse  
sander

la lame  
blade

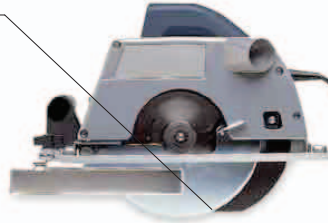

la scie circulaire  
circular saw



l'établi  
workbench

la colle à bois  
wood glue

la guimbarde  
router

les copeaux  
wood shavings



le porte-outils  
tool rack

le vilebrequin  
bit brace

la rallonge  
extension cord



## les techniques • techniques

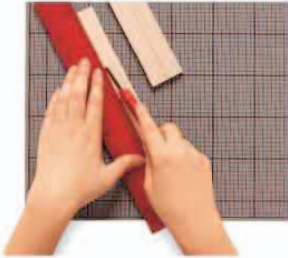

découper  
cut (v)



scier  
saw (v)



percer  
drill (v)



marteler  
hammer (v)



raboter  
plane (v)

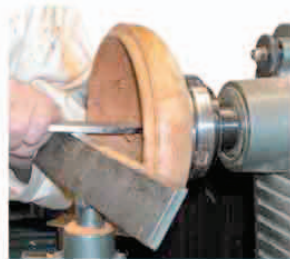

tourner  
turn (v)



sculpter  
carve (v)

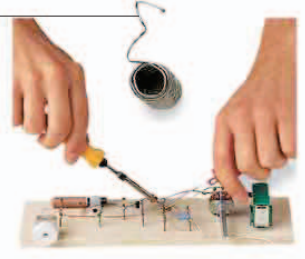

la soudure  
solder

souder  
solder (v)

## les matériaux • materials

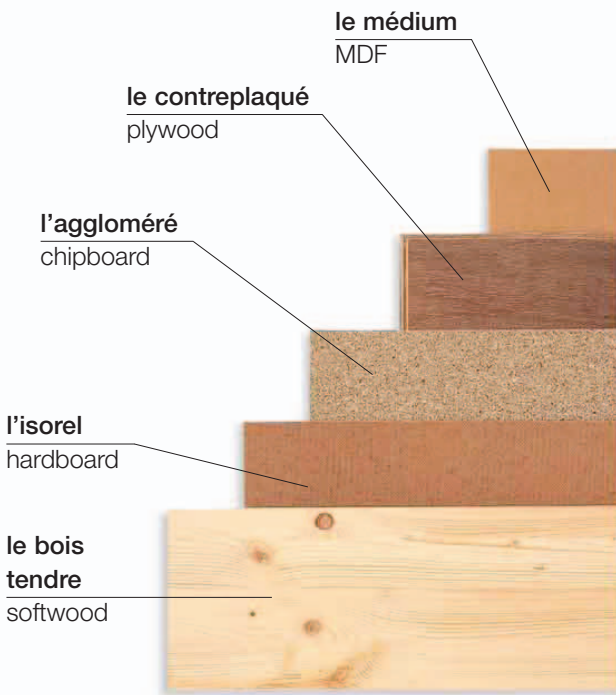

le bois tendre  
softwood

l'isorel  
hardboard

l'aggloméré  
chipboard

le contreplaqué  
plywood

le médium  
MDF

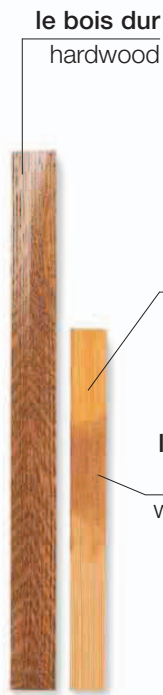

le bois dur  
hardwood

la couleur pour bois  
wood stain

le vernis  
varnish

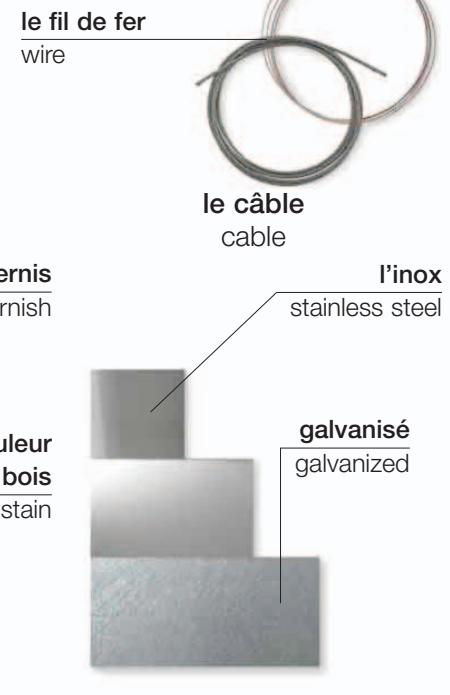

le fil de fer  
wire

le câble  
cable

l'inox  
stainless steel

galvanisé  
galvanized

le bois | wood

le métal | metal

# la boîte à outils • toolbox

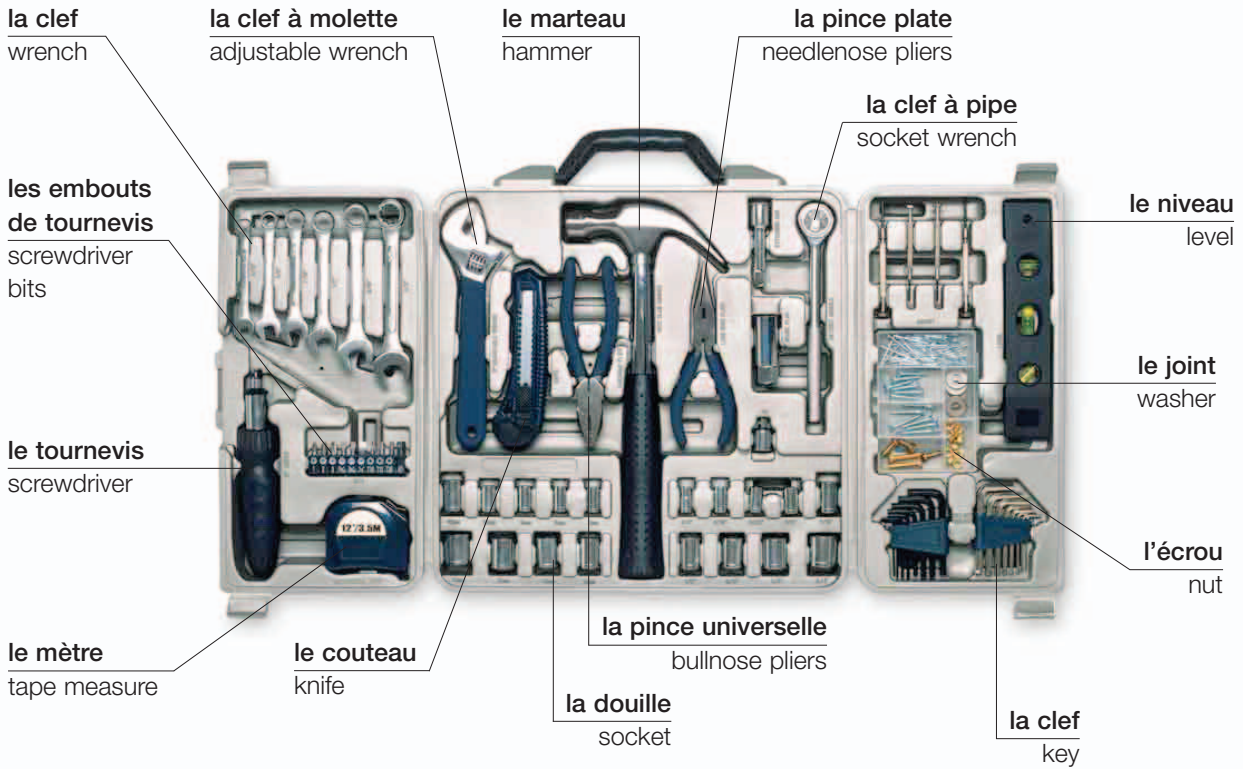

## les forets • drill bits

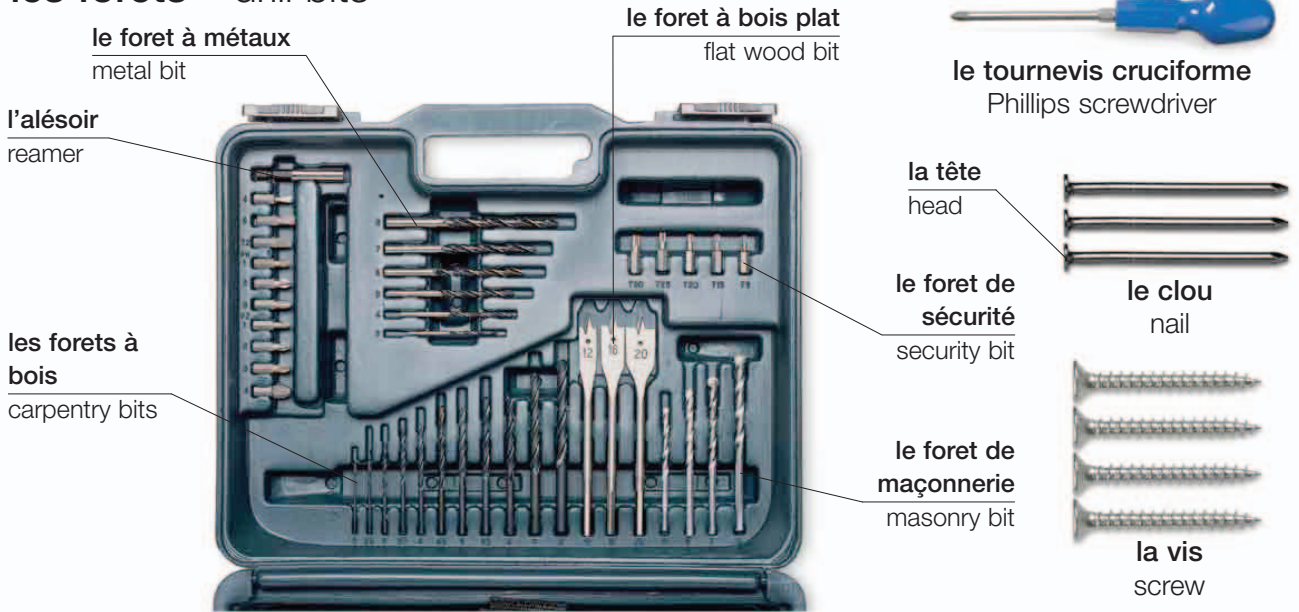

la pince à dénuder  
wire strippers

la pince coupante  
wire cutters

le fer à souder  
soldering iron

le ruban  
isolant  
insulating  
tape



la scie à  
chantourner  
fret saw

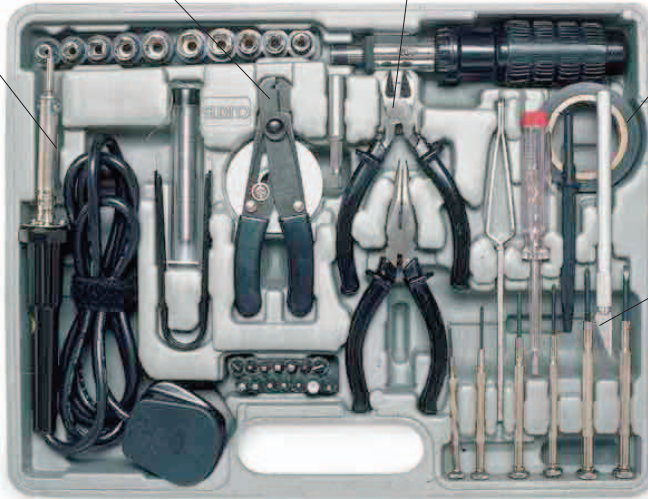

le scalpel  
craft knife



la scie à dossieret | tenon saw

la soudure  
solder



les lunettes de  
sécurité  
safety goggles



le rabot  
plane



la scie égoïne  
hand saw



la boîte à onglets  
miter block



la scie à métaux  
hacksaw



la perceuse  
manuelle  
hand drill



la paille de fer  
steel wool



le papier de verre  
sandpaper



la clef serre-tube  
wrench



le burin  
chisel



la lime  
file



la pierre à  
aiguiser  
whetstone



le coupe-tube | pipe cutter



la ventouse  
plunger



# la décoration • decorating



**les ciseaux**  
scissors



**le cutter**  
utility knife



**le fil à plomb**  
plumb line



**le grattoir**  
scraper

**le tapissier  
décorateur**  
decorator

**le papier peint**  
wallpaper

**l'escabeau**  
stepladder



**la brosse à  
tapisser**  
wallpaper brush

**la table à  
encoller**  
pasting table

**la brosse à  
encoller**  
pasting brush

**la colle à  
tapisser**  
wallpaper paste

**le seau**  
pail

**tapisser** | wallpaper (v)



**décoller**  
strip (v)



**mastiquer**  
fill (v)



**poncer**  
sand (v)



**plâtrer** | plaster (v)



**poser** | hang (v)



**carreler** | tile (v)



**peindre**  
paint (v)

**le rouleau**  
roller

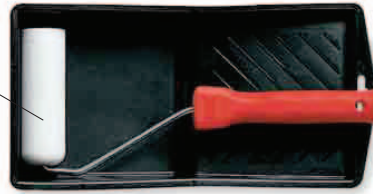

**le bac à peinture**  
paint tray



**la peinture**  
paint

**la brosse**  
brush



**l'éponge**  
sponge



**le papier cache**  
masking tape



**le papier de verre**  
sandpaper

**le pot de peinture**  
paint can

**le bleu**  
overalls

**la couverture de protection**  
dust sheet



**le mastic**  
filler

**la térébenthine**  
turpentine



**le white-spirit**  
mineral spirits

**vocabulaire** • vocabulary

**le plâtre**  
plaster

**brillant**  
gloss

**le papier gaufré**  
embossed paper

**la couche de fond**  
undercoat

**l'enduit**  
sealant

**le vernis**  
varnish

**mat**  
mat

**le papier d'apprêt**  
lining paper

**la dernière couche**  
topcoat

**le solvant**  
solvent

**la peinture mate**  
latex paint

**le pochoir**  
stencil

**l'apprêt**  
primer

**l'agent de conservation**  
preservative

**le mastic**  
grout

# le jardin • garden

## les styles de jardin • garden styles



**le patio**  
patio garden



**le jardin sur le toit**  
roof garden



**la rocaille**  
rock garden



**la cour**  
courtyard



**le jardin à la française** | formal garden



**le jardin paysan**  
cottage garden



**le jardin d'herbes  
aromatiques**  
herb garden



**le jardin d'eau**  
water garden

## les ornements de jardin • garden features



**le panier suspendu**  
hanging basket



**le treillis**  
trellis



**la pergola**  
pergola

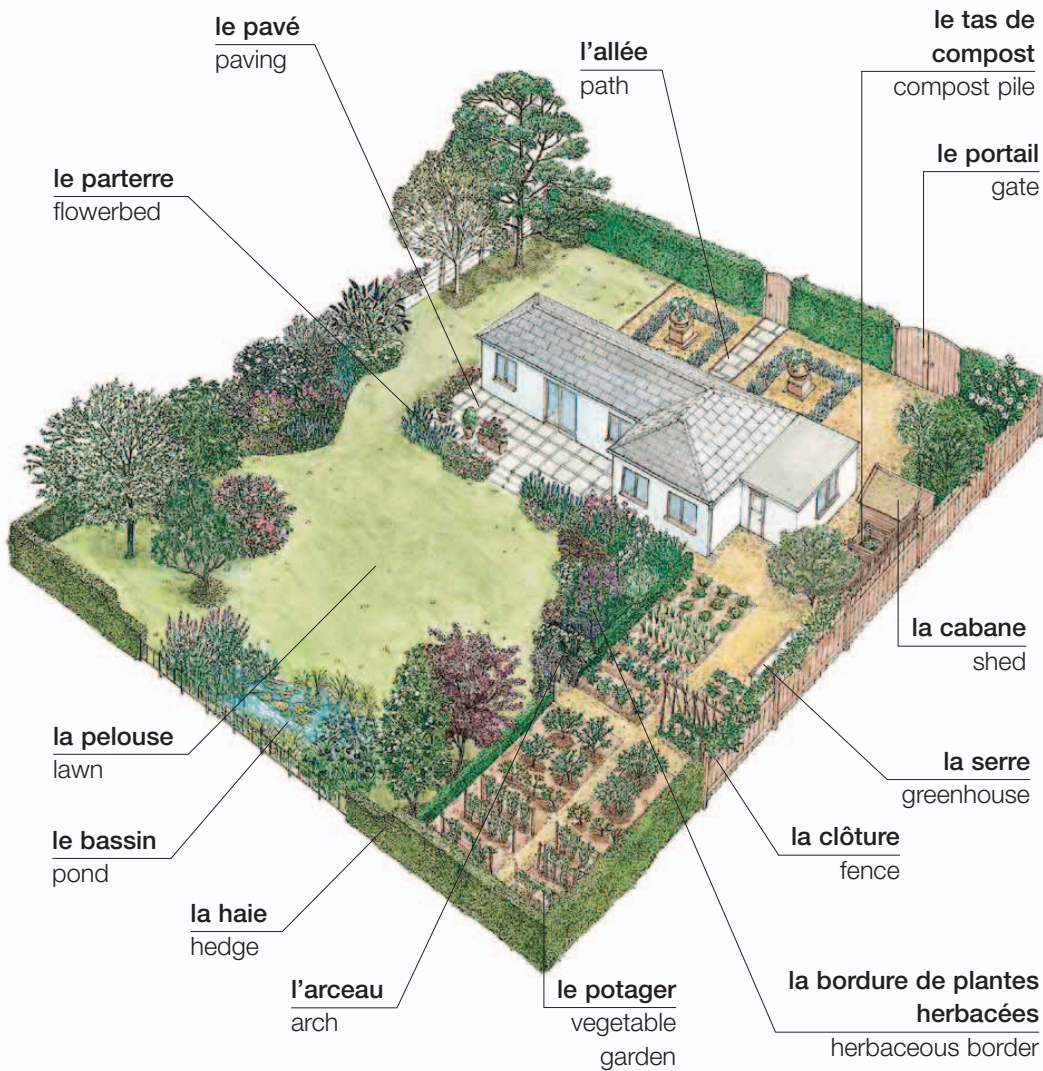

le sol • soil



la terre  
topsoil



le sable  
sand



la chaux  
chalk



la vase  
silt



l'argile  
clay



les planches  
decking



la fontaine | fountain

# les plantes de jardin • garden plants

## les genres de plantes • types of plants



**annuel**  
annual



**bisannuel**  
biennial



**vivace**  
perennial



**le bulbe**  
bulb



**la fougère**  
fern



**le jonc**  
rush



**le bambou**  
bamboo



**les mauvaises herbes**  
weeds



**l'herbe**  
herb



**la plante aquatique**  
water plant



**l'arbre**  
tree



**à feuilles caduques**  
deciduous



**le palmier**  
palm



**le conifère**  
conifer



**à feuilles persistantes**  
evergreen





**la topiaire**  
topiary



**la plante alpestre**  
alpine



**la plante grasse**  
succulent



**le cactus**  
cactus

**la plante en pot**  
potted plant

**la plante d'ombre**  
shade plant

**la plante grimpante**  
climber

**l'arbuste à fleurs**  
flowering shrub

**la couverture du sol**  
ground cover



**la plante rampante**  
creeper

**ornemental**  
ornamental

**l'herbe**  
grass

# les outils de jardin • garden tools



la bêche  
spade



la fourche  
fork



la grande cisaille  
long-handled shears



le balai à gazon  
lawn rake



le râtelier  
rake



la houe  
hoe



le terreau  
compost



les graines  
seeds



la cendre d'os  
bone meal



le gravier  
gravel



le sac à herbe  
grass bag

le moteur  
motor

le bras  
handle

l'écran de  
protection  
shield

la tondeuse  
trimmer

la tondeuse  
lawnmower



le panier de jardinier  
trug



le support  
stand

la brouette  
wheelbarrow



**la petite fourche**  
hand fork



**le sécateur**  
pruners



**le déplantoir**  
trowel



**le germoir**  
seed tray

**la lame**  
blade



**la cisaille**  
shears



**la scie à main**  
hand saw



**le pesticide**  
pesticide

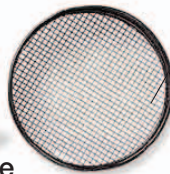

**le tamis**  
sieve



**les cannes**  
canes

**la ficelle**  
twine

**les étiquettes**  
labels

**les attaches**  
twist ties

**les anneaux**  
ring ties



**le pot à fleurs**  
plant pot



**les bottes**  
rubber boots

## l'arrosage • watering



**le vaporisateur**  
spray bottle



**l'arroseur**  
sprinkler

**le jet**  
nozzle

**l'arrosoir**  
watering can

**le tuyau d'arrosage**  
hose

**la pomme**  
rose

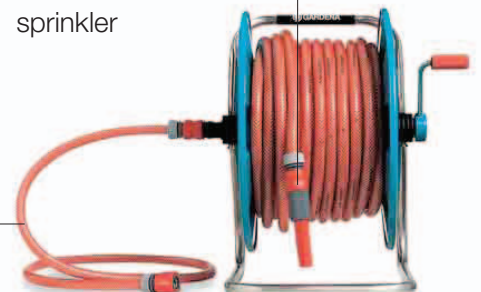

**le dévidoir de tuyau** | hose reel

# le jardinage • gardening



tondre | mow (v)



gazonner  
sod (v)



piquer  
spike (v)



ratissier  
rake (v)



tailler  
trim (v)



bêcher  
dig (v)



semer  
sow (v)



fumer en surface  
top-dress (v)



arroser  
water (v)



**palisser**  
train (v)



**enlever les fleurs fanées**  
deadhead (v)

**asperger**  
spray (v)



**greffer**  
graft (v)



**propager**  
propagate (v)

la coupe  
cutting



**élaguer**  
prune (v)



**mettre un tuteur**  
stake (v)



**transplanter**  
transplant (v)



**désherber**  
weed (v)



**pailler**  
mulch (v)



**récolter**  
harvest (v)

**vocabulaire** • vocabulary

**cultiver**  
cultivate (v)

**dessiner**  
landscape (v)

**fertiliser**  
fertilize (v)

**tamiser**  
sift (v)

**biologique**  
organic

**le semis**  
seedling

**le sous-sol**  
subsoil

**soigner**  
tend (v)

**mettre en pot**  
pot (v)

**cueillir**  
pick (v)

**retourner**  
aerate (v)

**le drainage**  
drainage

**l'engrais**  
fertilizer

**l'herbicide**  
weedkiller



**les services**  
services

# les services d'urgence • emergency services

## l'ambulance • ambulance



**l'ambulance**  
ambulance



**le brancard**  
stretcher

**l'infirmier du SAMU**  
paramedic

## la police • police

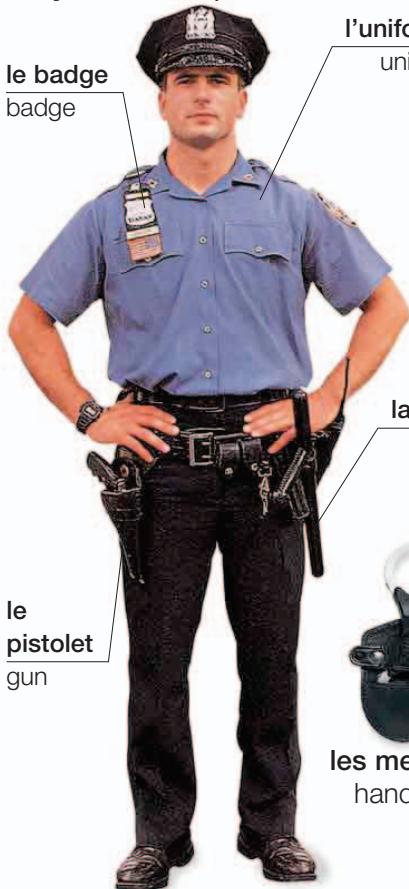

**le badge**  
badge

**l'uniforme**  
uniform

**la sirène**  
siren

**les feux**  
lights

**la matraque**  
nightstick

**le pistolet**  
gun

**les menottes**  
handcuffs

**le policier**  
police officer



**la voiture de police**  
police car



**le poste de police**  
police station

### vocabulaire • vocabulary

<b>l'inspecteur</b> inspector	<b>le suspect</b> suspect	<b>la plainte</b> complaint	<b>l'arrestation</b> arrest
<b>le crime</b> crime	<b>l'agression</b> assault	<b>l'enquête</b> investigation	<b>la cellule</b> cell
<b>l'officier de police</b> detective	<b>les empreintes</b> fingerprint	<b>le cambriolage</b> burglary	<b>l'accusation</b> charge



les pompiers • fire department



l'incendie | fire



le poste d'incendie  
fire station



l'escalier de secours  
fire escape



la fumée  
smoke

la casque  
helmet

le tuyau  
hose

la nacelle  
basket

les sapeurs-pompiers  
firefighters

le jet d'eau  
water jet

la flèche  
boom

l'échelle  
ladder

la cabine  
cab

la voiture de pompiers  
fire engine



le détecteur de  
fumée  
smoke alarm



l'avertisseur  
d'incendie  
fire alarm



la hache  
ax



l'extincteur  
fire extinguisher



la borne  
d'incendie  
hydrant

La police/les pompiers/une ambulance, s'il vous plaît.  
I need the police/fire department/ambulance.

Il y a un incendie à...  
There's a fire at...

Il y a eu un accident.  
There's been an accident.

Appelez la police!  
Call the police!

# la banque • bank

le client  
customer

le guichet  
window

le caissier  
teller



les dépliants  
brochures

le comptoir  
counter

les fiches de  
versement  
deposit slips

la carte bancaire  
debit card

le talon  
stub

le numéro de  
compte  
account number

la signature  
signature

le montant  
amount



le directeur  
d'agence  
bank manager



la carte de crédit  
credit card



le carnet de chèques  
checkbook

le chèque  
check

## vocabulaire • vocabulary

l'épargne  
savings

l'hypothèque  
mortgage

le paiement  
payment

verser  
deposit (v)

le compte courant  
checking account

l'impôt  
tax

le découvert  
overdraft

le prélèvement  
automatic  
payment

les frais bancaires  
bank charge

le compte d'épargne  
savings account

le prêt  
loan

le taux d'intérêt  
interest rate

la fiche de retrait  
withdrawal slip

le virement  
bancaire  
electronic transfer

le code secret  
PIN

la pièce  
coin



l'argent  
money

le billet  
bill

l'écran  
screen

le clavier  
keypad



le distributeur  
ATM

la fente  
card slot

les devises étrangères • foreign currency

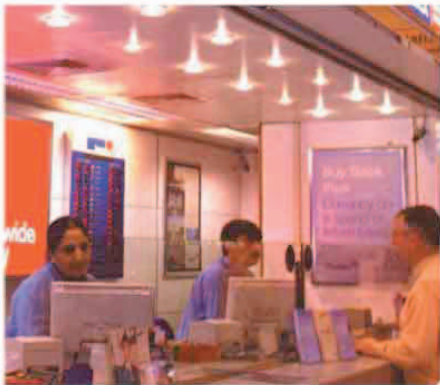

le bureau de change  
bureau de change



le traveller  
traveler's check



le taux de  
change  
exchange rate

vocabulaire • vocabulary

encaisser  
cash (v)

les actions  
shares

la valeur  
denomination

les dividendes  
dividends

la commission  
commission

le comptable  
accountant

l'investissement  
investment

le portefeuille  
portfolio

les titres  
stocks

l'action  
equity

Est-ce que je peux changer ça, s'il vous plaît?

Can I change this, please?

Quel est le taux de change aujourd'hui?

What's today's exchange rate?

la finance • finance

le prix des actions  
share price

l'agent de la  
bourse  
stockbroker



la conseillère financière  
financial advisor



la bourse | stock exchange

# les communications • communications

**le postier**  
postal worker

**le guichet**  
window

**la balance**  
scale

**le guichet**  
counter



**la poste** | post office

**le tampon de la poste**  
postmark

**le timbre**  
stamp

**l'adresse**  
address

**le code postal**  
ZIP code



**l'enveloppe** | envelope

**le facteur**  
mail carrier

## vocabulaire • vocabulary

**la lettre**  
letter

**l'expéditeur**  
return address

**la distribution**  
delivery

**fragile**  
fragile

**ne pas plier**  
do not bend (v)

**par avion**  
by airmail

**la signature**  
signature

**le mandat postal**  
money order

**le sac postal**  
mailbag

**dessus**  
this way up

**l'envoi en recommandé**  
registered mail

**la levée**  
pickup

**le tarif d'affranchissement**  
postage

**le télégramme**  
telegram

**le fax**  
fax



la boîte aux lettres  
mailbox



la boîte aux lettres  
letter slot



le colis  
package



le service de messagerie  
courier

## le téléphone • telephone

le combiné  
handset

la base  
base station



le téléphone sans fil  
cordless phone

le répondeur  
answering machine



le visiophone  
video phone



la cabine  
téléphonique  
telephone booth



le smartphone  
smartphone



le portable  
mobile phone

le clavier  
keypad



le combiné  
receiver

les pièces rendues  
coin return

le téléphone public  
payphone

## vocabulaire • vocabulary

les renseignements  
directory assistance

le SMS  
text

coupé  
disconnected

Pouvez-vous me donner le numéro pour...?

Can you give me the number for...?

le P.C.V.  
collect call

le message vocal  
voice message

l'appli  
app

Quel est l'indicatif pour...?

What is the area code for...?

composer  
dial (v)

le téléphoniste  
operator

le mot de  
passe  
passcode

Envoie-moi un SMS!

Text me!

répondre  
answer (v)

occupé  
busy

**l'hôtel** • hotel

**le hall** • lobby



**le client**  
guest

**la clef de la chambre**  
room key

**les messages**  
messages

**le casier**  
pigeonhole

**la réceptionniste**  
receptionist

**le registre**  
register

**le comptoir**  
counter

**la réception** | reception



**le porteur**  
porter

**les bagages**  
luggage

**le diable**  
cart



**l'ascenseur**  
elevator



**le numéro de chambre**  
room number

**les chambres** • rooms



**la chambre simple**  
single room

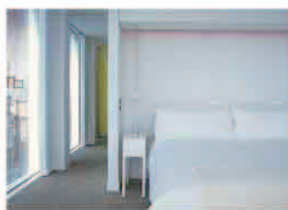

**la chambre double**  
double room



**la chambre à deux lits**  
twin room



**la salle de bain privée**  
private bathroom

les services • services



**le service de ménage**  
maid service



**le service de blanchisserie**  
laundry service

**le plateau à petit déjeuner**  
breakfast tray



**le service d'étage** | room service



**le minibar**  
mini bar



**le restaurant**  
restaurant



**la salle de sport**  
gym



**la piscine**  
swimming pool

vocabulaire • vocabulary

**la chambre avec le petit déjeuner**

bed and breakfast

**Avez-vous une chambre de libre?**

Do you have any vacancies?

**Je voudrais une chambre pour trois nuits.**

I'd like a room for three nights.

**la pension complète**

full board

**J'ai une réservation.**

I have a reservation.

**C'est combien par nuit?**

What is the charge per night?

**la demi-pension**

half-board

**Je voudrais une chambre simple.**

I'd like a single room.

**Quand est-ce que je dois quitter la chambre?**

When do I have to check out?



[WWW.EBOOK777.COM](http://WWW.EBOOK777.COM)





les courses  
shopping

[WWW.EBOOK777.COM](http://WWW.EBOOK777.COM)

# le centre commercial • shopping center

**l'atrium**  
atrium

**l'enseigne**  
sign

**l'ascenseur**  
elevator



**le deuxième étage**  
third floor

**le premier étage**  
second floor

**l'escalier mécanique**  
escalator

**le rez-de-chaussée**  
ground floor

**le client**  
customer

## vocabulaire • vocabulary

**le rayon enfants**  
children's department

**le guide**  
store directory

**les cabines d'essayage**  
changing rooms

**C'est combien?**  
How much is this?

**le rayon bagages**  
luggage department

**le vendeur**  
sales clerk

**les soins de bébés**  
baby changing facilities

**Est-ce que je peux changer ça?**  
May I exchange this?

**le rayon chaussures**  
shoe department

**le service après-vente**  
customer services

**les toilettes**  
restrooms

le grand magasin • department store



les vêtements pour hommes  
menswear



les vêtements pour femmes  
women's clothing



la lingerie  
lingerie



la parfumerie  
perfume



la beauté  
beauty



le linge de maison  
linen



l'ameublement  
home furnishings



la mercerie  
notions



la vaisselle  
kitchenware



la porcelaine  
china



l'électroménager  
electrical goods



l'éclairage  
lighting



les articles de sport  
sports



les jouets  
toys



la papeterie  
stationery



l'alimentation  
food

# le supermarché • supermarket

**l'allée**  
aisle

**l'étagère**  
shelf

**le tapis roulant**  
conveyer belt

**le caissier**  
checker

**les promotions**  
specials



**la caisse** | checkout

**le client**  
customer

**la caisse**  
cash register

**la sac à provisions**  
shopping bag



**les provisions**  
groceries

**l'anse**  
handle



**le code barres**  
bar code

**le caddie**  
cart



**le panier**  
basket



**le lecteur optique**  
scanner



**la boulangerie**  
bakery



**la cr merie**  
dairy



**les c r ales**  
cereals



**les conserves**  
canned food



**la confiserie**  
candy



**les l gumes**  
vegetables



**les fruits**  
fruit



**la viande et la volaille**  
meat and poultry

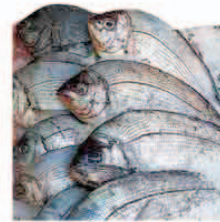

**le poisson**  
fish



**la charcuterie**  
deli



**les produits surgel s**  
frozen food



**les plats cuisin s**  
convenience food



**les boissons**  
drinks



**les produits d'entretien**  
household products



**les articles de toilette**  
toiletries



**les articles pour b b s**  
baby products



**l' lectrom nager**  
electrical goods



**la nourriture pour animaux**  
pet food



**les magazines** | magazines

# la pharmacie • drugstore

les soins  
dentaires  
dental care

l'hygiène  
féminine  
feminine  
hygiene

les déodorants  
deodorants

les vitamines  
vitamins

l'officine  
pharmacy

le pharmacien  
pharmacist

le médicament pour  
la toux  
cough medicine

l'herboristerie  
herbal remedies

les soins de la peau  
skin care



l'après-soleil  
aftersun

l'écran solaire  
sunscreen



l'écran total  
sunblock



le produit anti-insecte  
insect repellent



la lingette humide  
wet wipe



le kleenex  
tissue



la serviette hygiénique  
sanitary napkin



le tampon  
tampon



le protège-slip  
panty liner



**la gélule**  
capsule



**la pilule**  
pill

**la cuiller pour mesurer**  
measuring spoon



**le sirop**  
syrup

**le mode d'emploi**  
instructions



**l'inhalateur**  
inhaler



**la crème**  
cream



**la pommade**  
ointment



**le gel**  
gel



**le suppositoaire**  
suppository

**le compte-gouttes**  
dropper



**les gouttes**  
drops



**l'aiguille**  
needle

**la seringue**  
syringe



**le spray**  
spray



**la poudre**  
powder

**vocabulaire • vocabulary**

**le fer**  
iron

**l'insuline**  
insulin

**jetable**  
disposable

**le médicament**  
medicine

**l'analgésique**  
painkiller

**le calcium**  
calcium

**les effets secondaires**  
side effects

**soluble**  
soluble

**le laxatif**  
laxative

**le sédatif**  
sedative

**le magnésium**  
magnesium

**la date d'expiration**  
expiration date

**la posologie**  
dosage

**la diarrhée**  
diarrhea

**le somnifère**  
sleeping pill

**le médicament multivitamine**  
multivitamins

**les cachets antinaupathiques**  
travel sickness pills

**la médication**  
medication

**la pastille pour la gorge**  
cough drop

**l'anti-inflammatoire**  
anti-inflammatory

# le fleuriste • florist

les fleurs  
flowers

le lis  
lily

l'acacia  
acacia

l'œillet  
carnation

la plante en pot  
potted plant



le glaïeul  
gladiolus

l'iris  
iris

la marguerite  
daisy

le  
chrysanthème  
chrysanthemum

la gypsophile  
gypsophila



la giroflée  
stocks



le gerbera  
gerbera



le feuillage  
foliage



la rose  
rose



le freesia  
freesia



les compositions florales • arrangements

le vase  
vase



l'orchidée  
orchid



la pivoine  
peony

la botte  
bunch

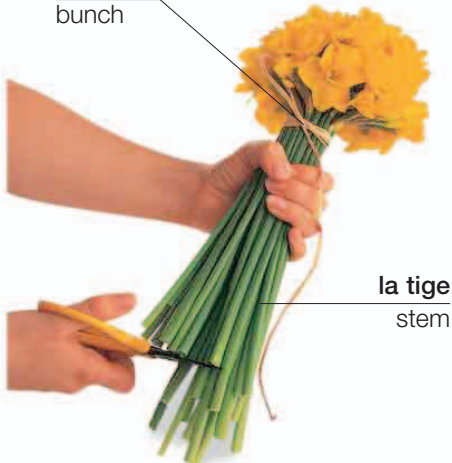

la jonquille  
daffodil

la tige  
stem

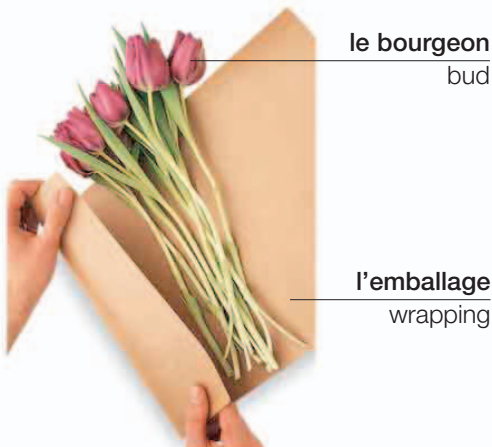

la tulipe | tulip

le bourgeon  
bud

l'emballage  
wrapping

le ruban  
ribbon



le bouquet  
bouquet



les fleurs séchées  
dried flowers



le pot-pourri | potpourri



la couronne | wreath



la guirlande  
de fleurs  
garland

Je peux y attacher un message?  
Can I attach a message?

Est-ce qu'elles sentent bon?  
Are they fragrant?

Pouvez-vous les emballer?  
Can I have them wrapped?

Elles tiennent combien de temps?  
How long will these last?

Pouvez-vous les envoyer à...?  
Can you send them to...?

Je voudrais un bouquet de..., SVP.  
Can I have a bunch of..., please.

# le marchand de journaux • newsstand



les cigarettes  
cigarettes

le paquet de cigarettes  
pack of cigarettes

les timbres  
stamps



la carte postale  
postcard



la bande dessinée  
comic book



le magazine  
magazine



le journal  
newspaper

## fumer • smoking



le tabac  
tobacco



le briquet  
lighter



le fourneau  
bowl

la pipe  
pipe



le cigare  
cigar

# le confiseur • confectionery

la boîte de chocolats  
box of chocolates

la friandise  
snack bar

les chips  
chips



la confiserie | candy store

## vocabulaire • vocabulary

le chocolat au lait  
milk chocolate

le caramel  
caramel

le chocolat noir  
semisweet  
chocolate

la truffe  
truffle

le chocolat blanc  
white chocolate

le biscuit  
cookie

les bonbons  
assortis  
pick and mix

les bonbons  
hard candy

## la confiserie • confectionery



le chocolat  
chocolate



la tablette de  
chocolat  
chocolate bar



les bonbons  
candies



la sucette  
lollipop



le caramel  
toffee



le nougat  
nougat



la guimauve  
marshmallow



le bonbon à la menthe  
mint



le chewing-gum  
chewing gum



la dragée à la gelée  
jellybean



le bonbon au fruit  
gumdrop



le réglisse  
licorice

# les autres magasins • other stores



**la boulangerie**  
bread shop



**la pâtisserie**  
bakery



**la boucherie**  
butcher shop



**la poissonnerie**  
fish-seller



**le marchand de légumes**  
produce stand



**l'épicerie**  
grocery store



**le magasin de chaussures**  
shoe store



**la quincaillerie**  
hardware store



**le magasin d'antiquités**  
antique store



**la boutique de cadeaux**  
gift shop



**l'agence de voyage**  
travel agent



**la bijouterie**  
jewelry store



**la librairie**  
bookstore



**le magasin de disques**  
record store



**le magasin de vins et spiritueux**  
liquor store



**l'animalerie**  
pet store



**le magasin de meubles**  
furniture store



**la boutique**  
boutique



**le tailleur**  
tailor shop



**le salon de coiffure**  
beauty salon

**vocabulaire • vocabulary**

<b>l'agent immobilier</b> realtor	<b>le magasin d'appareils photos</b> camera store
<b>la pépinière</b> garden center	<b>le magasin bio</b> health food store
<b>le pressing</b> dry-cleaner	<b>la boutique d'art</b> art store
<b>la laverie automatique</b> laundromat	<b>le marchand d'occasion</b> second-hand store



**le marché | market**





la nourriture  
food

[WWW.EBOOK777.COM](http://WWW.EBOOK777.COM)

# la viande • meat

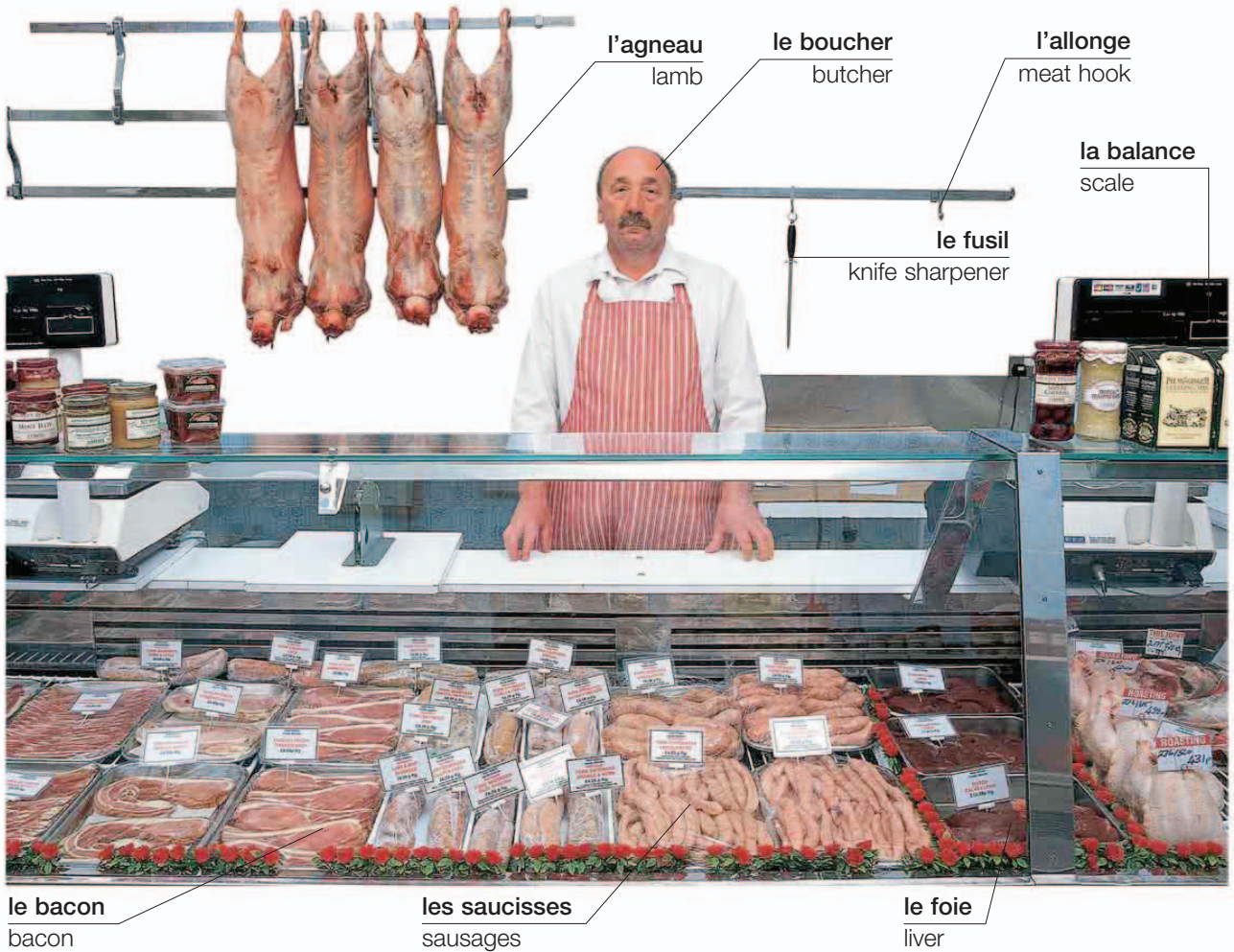

## vocabulaire • vocabulary

**le porc**  
pork

**la venaison**  
venison

**les abats**  
offal

**de ferme**  
free range

**la viande rouge**  
red meat

**le bœuf**  
beef

**le lapin**  
rabbit

**salé**  
cured

**naturel**  
organic

**la viande maigre**  
lean meat

**le veau**  
veal

**la langue de bœuf**  
tongue

**fumé**  
smoked

**la viande blanche**  
white meat

**la viande cuite**  
cooked meat



les morceaux de viande • cuts

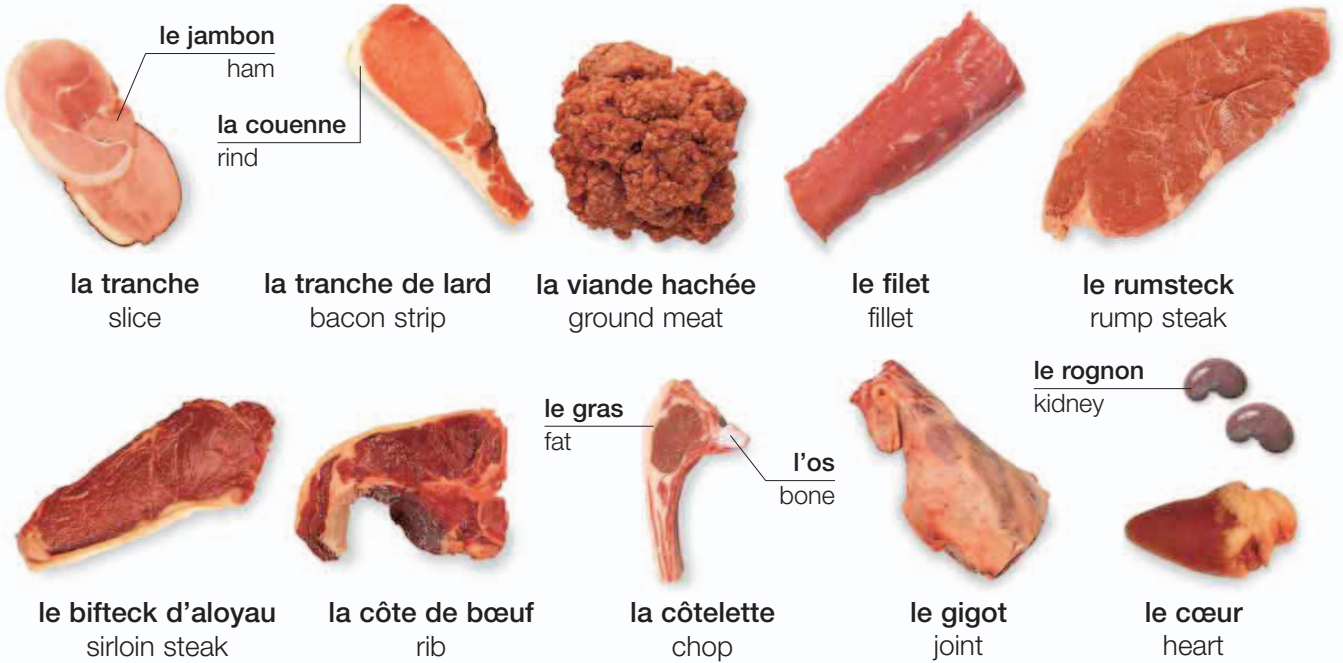

la volaille • poultry

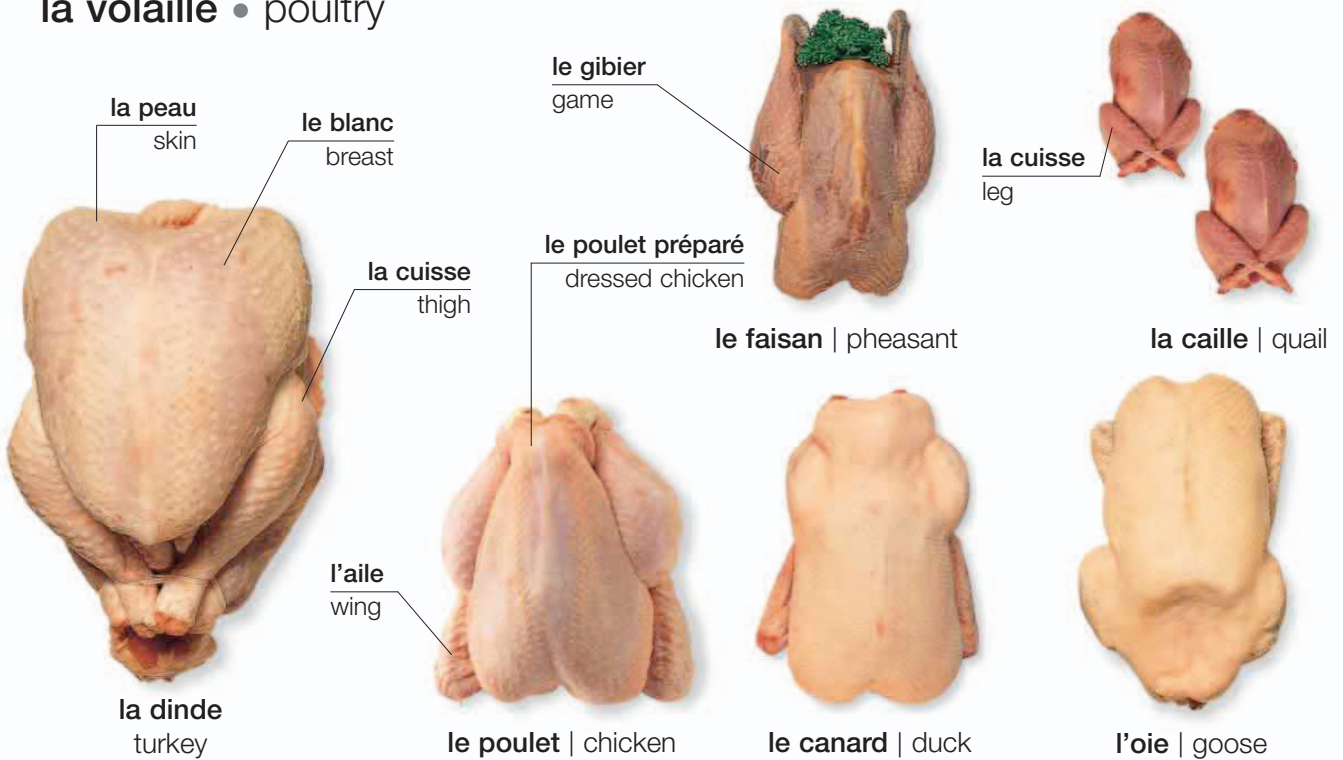

# le poisson • fish

les crevettes  
décortiquées  
peeled shrimp

la glace  
ice

le rouget barbet  
red mullet

les filets de  
flétan  
halibut fillets

la truite arc-en-ciel  
rainbow trout

les ailes de raie  
skate wings

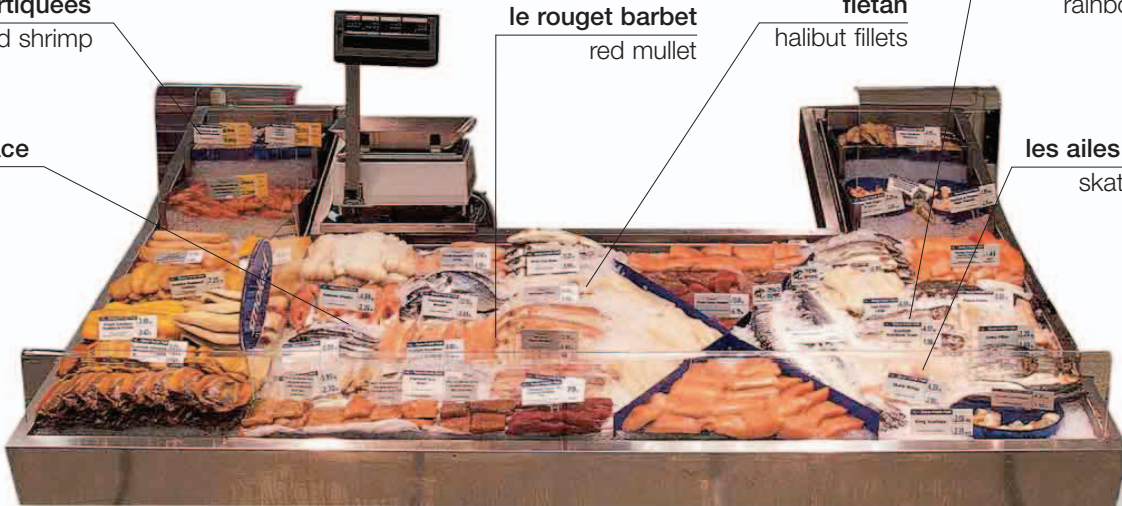

la poissonnerie  
fish counter



la lotte  
monkfish



le maquereau  
mackerel



la truite  
trout



l'espadon  
swordfish



la sole  
Dover sole



la limande-sole  
lemon sole



l'aiglefin  
haddock



la sardine  
sardine



la raie  
skate



le merlan  
whiting



le bar  
sea bass



le saumon | salmon



la morue  
cod



la daurade  
sea bream



le thon  
tuna

les fruits de mer • seafood

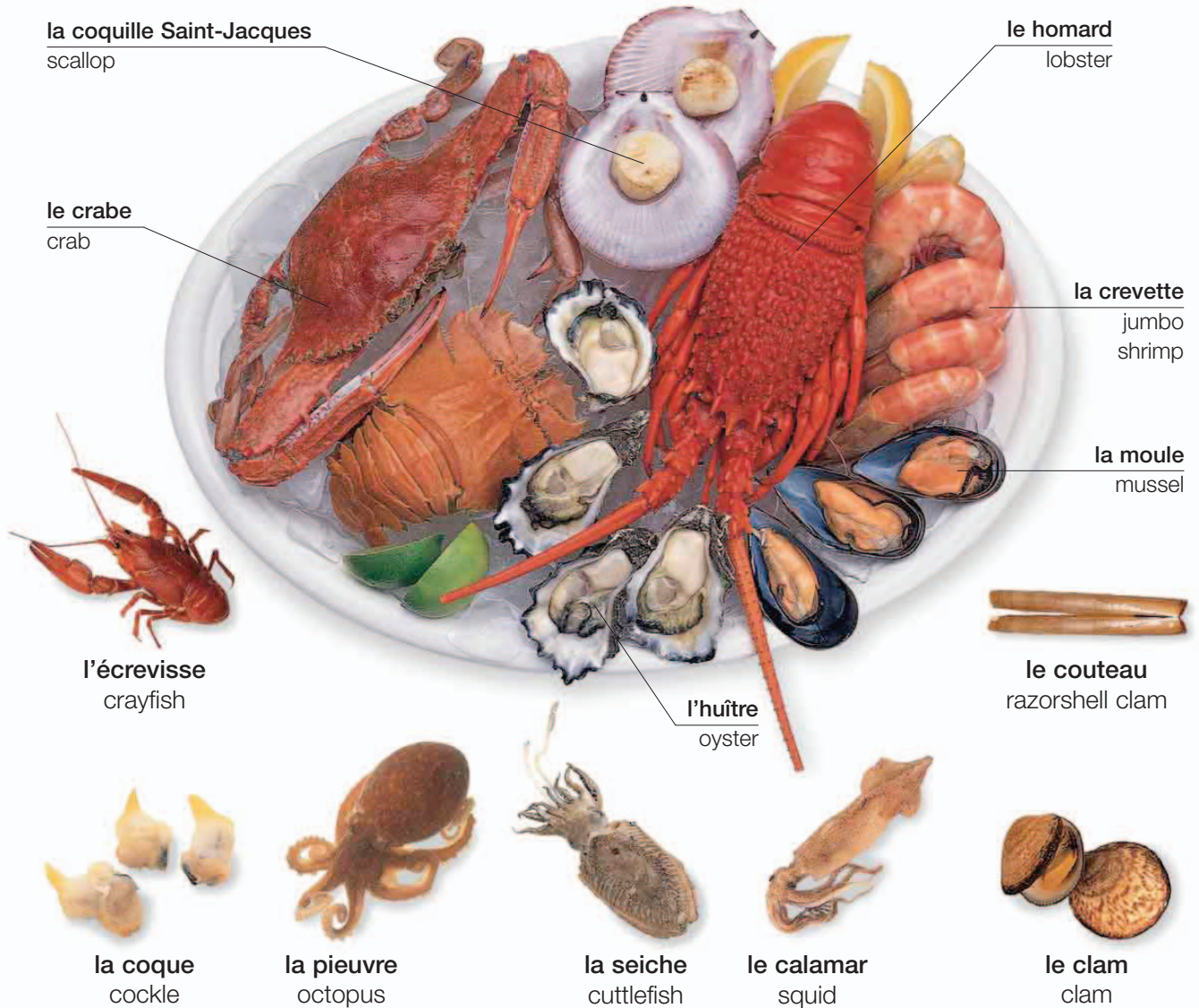

vocabulaire • vocabulary

<b>surgelé</b> frozen	<b>préparé</b> cleaned	<b>fumé</b> smoked	<b>écaillé</b> descaled	<b>le filet</b> fillet	<b>la longe</b> loin	<b>la queue</b> tail	<b>l'arête</b> bone	<b>l'écaille</b> scale
<b>frais</b> fresh	<b>salé</b> salted	<b>sans</b> <b>peau</b> skinned	<b>sans</b> <b>arêtes</b> boned	<b>en</b> <b>filets</b> filleted	<b>la</b> <b>tranche</b> steak	<b>Pouvez-vous le préparer pour moi?</b> Will you clean it for me?		

# les légumes 1 • vegetables 1



**la fève**  
fava bean



**le haricot grim pant**  
green bean



**le haricot vert**  
French bean



**le petit pois**  
garden pea



**le maïs**  
corn



**le germe de soja**  
bean sprout



**le bambou**  
bamboo

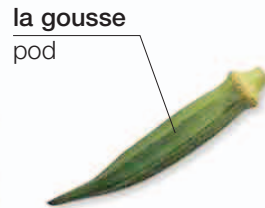

**l'okra**  
okra



**le céleri**  
celery



**l'endive**  
chicory



**le fenouil**  
fennel



**les cœurs de palmier**  
palm hearts

## vocabulaire • vocabulary

**la feuille**  
leaf

**la fleurette**  
floret

**la pointe**  
tip

**biologique**  
organic

**le trognon**  
stalk

**le grain**  
kernel

**le cœur**  
heart

**le sac en plastique**  
plastic bag

Est-ce que vous vendez des légumes bios?  
Do you sell organic vegetables?

Est-ce qu'ils sont cultivés dans la région?  
Are these grown locally?



**la roquette**  
arugula



**le cresson**  
watercress



**le radicchio**  
radicchio



**le chou de Bruxelles**  
Brussels sprout



**la bette**  
Swiss chard



**le chou frisé**  
kale



**l'oseille**  
sorrel



**la chicorée**  
endive



**le pissenlit**  
dandelion



**les épinards**  
spinach



**le chou-rave**  
kohlrabi



**le chou chinois**  
pak-choi



**la laitue**  
lettuce



**le brocoli**  
broccoli



**le chou**  
cabbage



**le chou précoce**  
spring greens

# les légumes 2 • vegetables 2

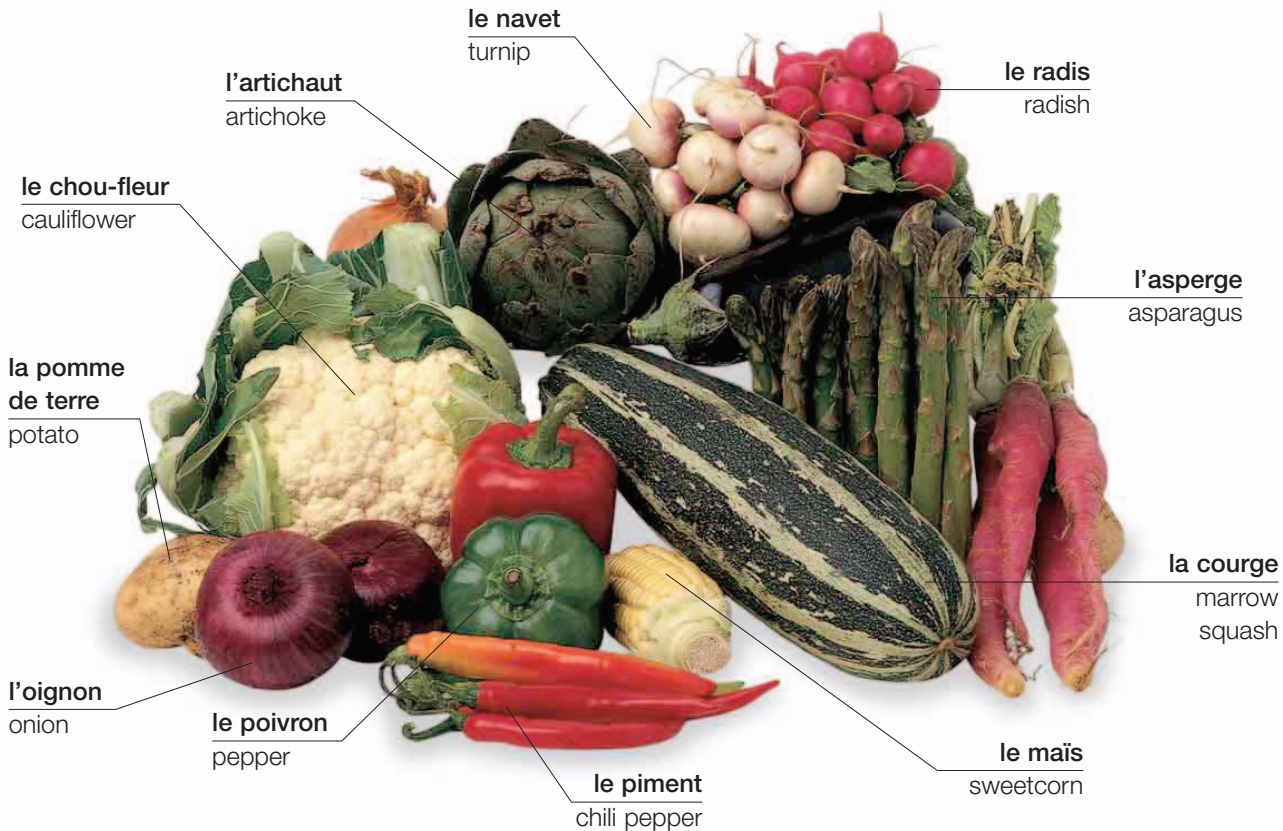

## vocabulaire • vocabulary

**la tomate cerise**  
cherry tomato

**le céleri**  
celeriac

**surgelé**  
frozen

**amer**  
bitter

**Puis-je avoir un kilo de pommes de terre s'il vous plaît?**

**la carotte**  
carrot

**le taro**  
taro root

**cru**  
raw

**ferme**  
firm

Can I have one kilo of potatoes, please?

**le fruit de l'arbre à pain**  
breadfruit

**le manioc**  
cassava

**épicé**  
hot (spicy)

**la pulpa**  
flesh

**C'est combien le kilo?**  
What's the price per kilo?

**la pomme de terre nouvelle**  
new potato

**la châtaigne d'eau**  
water chestnut

**sucré**  
sweet

**la racine**  
root

**Ils s'appellent comment?**  
What are those called?



**la patate douce**  
sweet potato



**l'igname**  
yam



**la betterave**  
beet



**le rutabaga**  
rutabaga



**le topinambour**  
Jerusalem  
artichoke



**le raifort**  
horseradish



**le panais**  
parsnip



**le gingembre**  
ginger



**l'aubergine**  
eggplant



**la tomate**  
tomato



**la ciboule**  
green onion



**le poireau**  
leek



**l'échalote**  
shallot



**l'ail**  
garlic

**la gousse**  
clove



**le champignon**  
mushroom

**la truffe**  
truffle



**le concombre**  
cucumber



**la courgette**  
zucchini



**la courge musquée**  
butternut squash



**la courge gland**  
acorn squash



**la citrouille**  
pumpkin

# le fruit 1 • fruit 1

## les agrumes • citrus fruit



**l'orange**  
orange



**la clémentine**  
clementine

**la peau  
blanche**  
pith



**le tangelo**  
ugli fruit

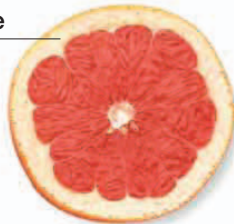

**le pamplemousse**  
grapefruit

**le quartier**  
segment



**la mandarine**  
tangerine

**la satsuma**  
satsuma



**le zeste**  
zest

**le citron vert**  
lime



**le citron**  
lemon



**le kumquat**  
kumquat

## les fruits à noyau • stone fruit



**la pêche**  
peach



**la nectarine**  
nectarine



**l'abricot**  
apricot



**la prune**  
plum



**la cerise**  
cherry

**la poire**  
pear

**la pomme**  
apple



**la corbeille de fruits** | basket of fruit



les fruits rouges et les melons • berries and melons



la fraise  
strawberry



la framboise  
raspberry



le melon  
melon



les raisins  
grapes



la mûre  
blackberry



la groseille  
red currant



le cassis  
black currant



la canneberge  
cranberry



la myrtille  
blueberry



la groseille blanche  
white currant

l'écorce  
rind

le pépin  
seed

la pulpe  
flesh

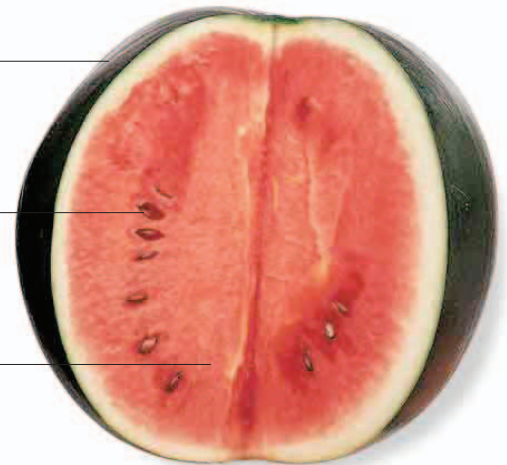

la pastèque  
watermelon



la loganberry  
loganberry



la groseille à  
maquereau  
gooseberry

vocabulaire • vocabulary

la rhubarbe  
rhubarb

aigre  
sour

croquant  
crisp

le jus  
juice

Est-ce qu'ils sont  
mûrs?

Are they ripe?

la fibra  
fiber

frais  
fresh

pourri  
rotten

le trognon  
core

Je peux goûter?

Can I try one?

sucré  
sweet

juteux  
juicy

la pulpe  
pulp

sans pépins  
seedless

Ils se gardent  
combien de temps?

How long will they  
keep?

# les fruits 2 • fruit 2

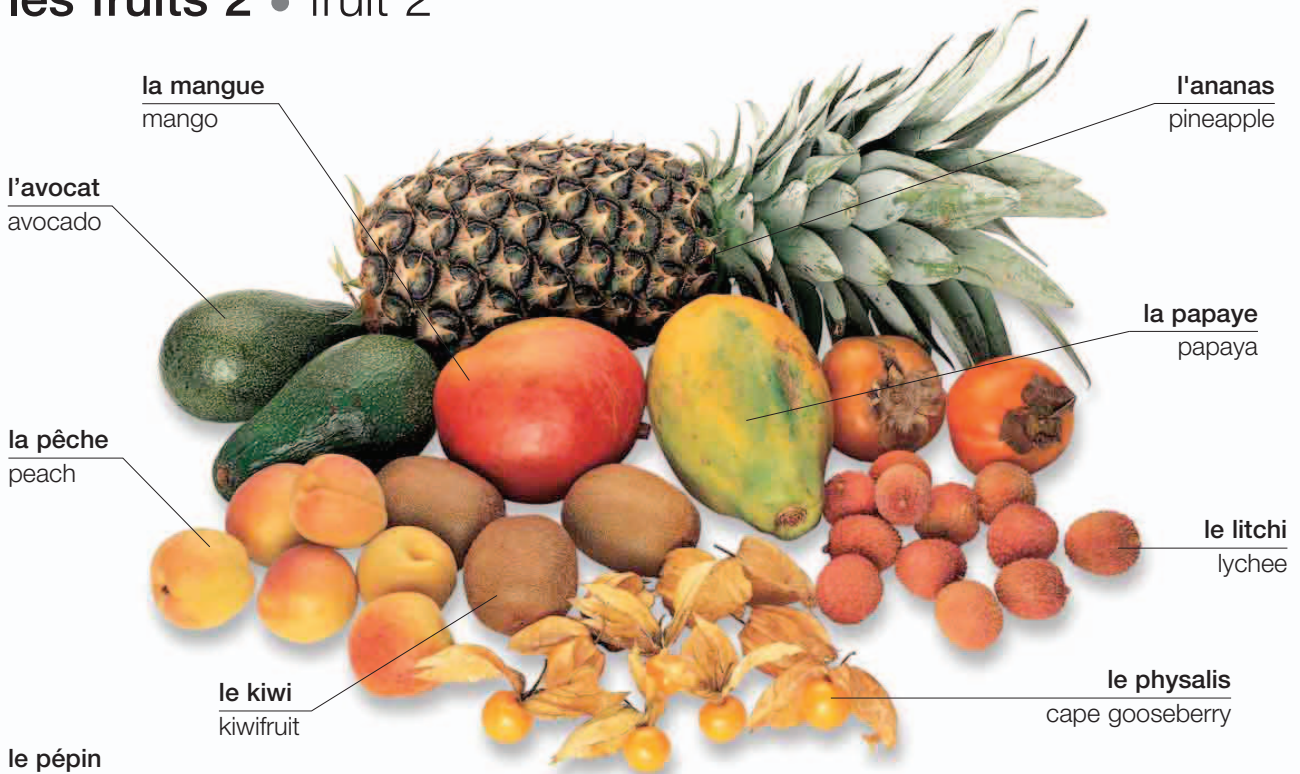

les noix et les fruits secs • nuts and dried fruit



le pignon  
pine nut



la pistache  
pistachio



la noix de cajou  
cashew



la cacahouète  
peanut



la noisette  
hazelnut



la noix du Brésil  
Brazil nut



la noix pacane  
pecan



l'amande  
almond



la noix  
walnut



le marron  
chestnut



le macadamia  
macadamia



la figue  
fig



la datte  
date



le pruneau  
prune

la coquille  
shell



le raisin de  
Smyrne  
sultana raisin



le raisin sec  
raisin



le raisin de  
Corinthe  
currant

la chair  
flesh

la noix de coco  
coconut



vocabulaire • vocabulary

vert  
green

dur  
hard

l'amande  
kernel

salé  
salted

grillé  
roasted

décortiqué  
shelled

le fruit confit  
candied fruit

mûr  
ripe

mou  
soft

séché  
desiccated

cru  
raw

de saison  
seasonal

complet  
whole

les fruits tropicaux  
tropical fruit

# les céréales et les légumes secs • grains and legumes

## les céréales • grains



**le blé**  
wheat



**l'avoine**  
oats



**l'orge**  
barley

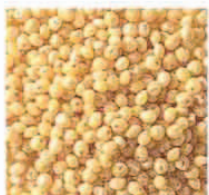

**le millet**  
millet



**le maïs**  
corn

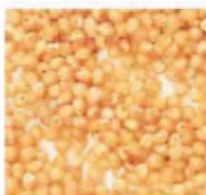

**le quinoa**  
quinoa

### vocabulaire • vocabulary

**la graine**  
seed

**parfumé**  
fragranced

**facile à cuisiner**  
easy-cook

**la balle**  
husk

**la céréale**  
cereal

**à grains longs**  
long-grain

**le grain**  
kernel

**complet**  
whole-grain

**à grains ronds**  
short-grain

**sec**  
dry

**laisser tremper**  
soak (v)

**frais**  
fresh

## le riz • rice



**le riz blanc**  
white rice



**le riz complet**  
brown rice



**le riz sauvage**  
wild rice



**le riz rond**  
pudding rice

## les céréales traitées • processed grains



**le couscous**  
couscous



**le blé écrasé**  
cracked wheat



**la semoule**  
semolina



**le son**  
bran

les haricots et les pois • beans and peas



**les gros haricots blancs**  
butter beans



**les haricots blancs**  
haricot beans



**les haricots rouges**  
red kidney beans



**les adzukis**  
aduki beans



**les fèves**  
fava beans



**les graines de soja**  
soybeans



**les haricots à œil noir**  
black-eyed beans



**les haricots pinto**  
pinto beans



**les haricots mung**  
mung beans



**les flageolets**  
flageolet beans



**les lentilles**  
brown lentils



**les lentilles rouges**  
red lentils



**les petits pois**  
green peas



**les pois chiches**  
garbanzos



**les pois cassés**  
split peas

les graines • seeds



**la graine de potiron**  
pumpkin seed



**le grain de moutarde**  
mustard seed



**la graine de carvi**  
caraway



**la graine de sésame**  
sesame seed

**la graine de tournesol**  
sunflower seed



# les herbes et les épices • herbs and spices

## les épices • spices



la vanille  
vanilla



la noix de  
muscade  
nutmeg



le macis  
mace



le curcuma  
turmeric



le cumin  
cumin



le bouquet garni  
bouquet garni



le poivre de la  
Jamaïque  
allspice

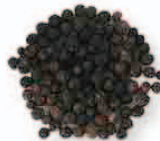

le grain de  
poivre  
peppercorn



le fenugrec  
fenugreek



le piment  
chili powder

en morceaux  
whole

écrasé  
crushed



le safran  
saffron



la cardamome  
cardamom



la poudre de  
curry  
curry powder

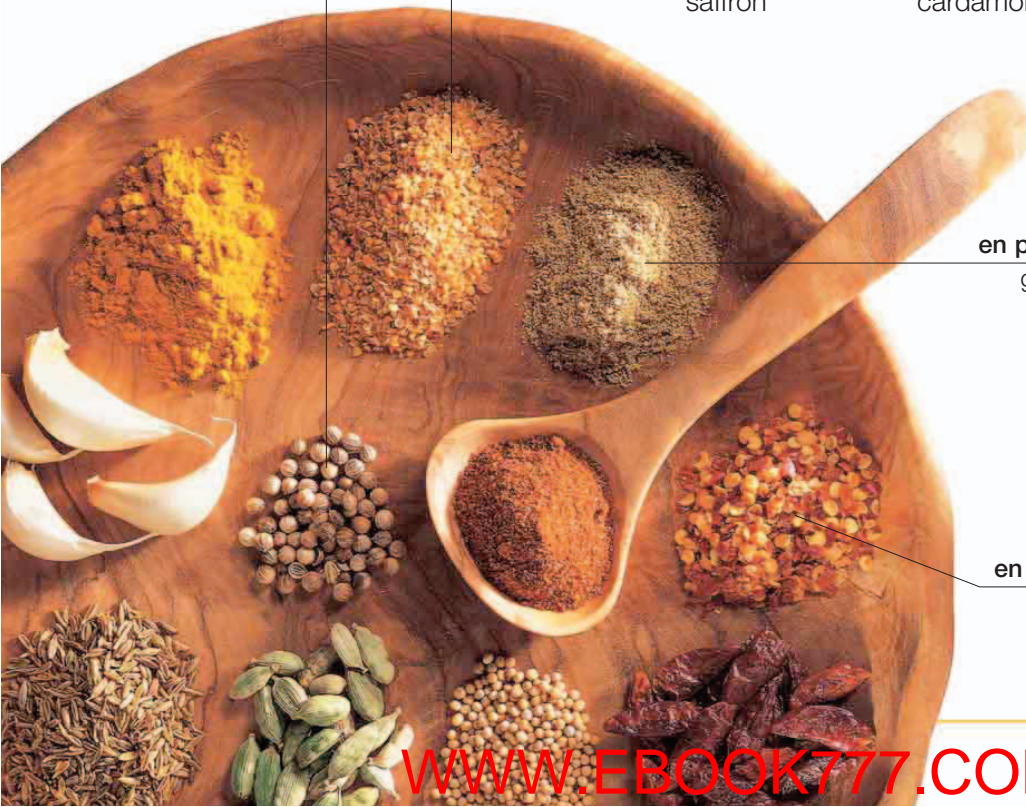

en poudre  
ground



le paprika  
paprika

en flocons  
flakes



l'ail  
garlic

les herbes • herbs

les bâtons  
sticks



la cannelle  
cinnamon



la citronnelle  
lemon grass



le clou de girofle  
cloves



l'anis étoilé  
star anise



le gingembre  
ginger

les graines de  
fenouil  
fennel seeds



le fenouil  
fennel



la ciboulette  
chives



la menthe  
mint



la feuille de laurier  
bay leaf



le persil  
parsley



le thym  
thyme



la sauge  
sage



l'estragon  
tarragon



la marjolaine  
marjoram



le basilic  
basil



l'origan  
oregano



la coriandre  
cilantro



l'aneth  
dill



le romarin  
rosemary

## les aliments en bouteilles • bottled foods



## les produits à tartiner • sweet spreads





les condiments • condiments and spreads



la mayonnaise  
mayonnaise

le vinaigre de  
cidre  
cider vinegar



le vinaigre  
balsamique  
balsamic vinegar



le vinaigre de malt  
malt vinegar



le vinaigre de vin  
wine vinegar



le vinaigre  
vinegar



la bouteille  
bottle

le ketchup  
ketchup



la sauce  
sauce



la moutarde  
anglaise  
English mustard



la moutarde  
française  
French mustard



la moutarde  
en grains  
whole-grain  
mustard



le chutney  
chutney



le beurre de  
cacahouètes  
peanut butter



la pâte à tartiner  
au chocolat  
chocolate spread



les fruits en  
bocaux  
preserved fruit

le bocal scellé  
sealed jar

vocabulaire • vocabulary

l'huile de maïs  
corn oil

l'huile de colza  
canola oil

l'huile  
d'arachide  
peanut oil

l'huile pressée  
à froid  
cold-pressed oil

l'huile végétale  
vegetable oil

# les produits laitiers • dairy produce

## le fromage • cheese

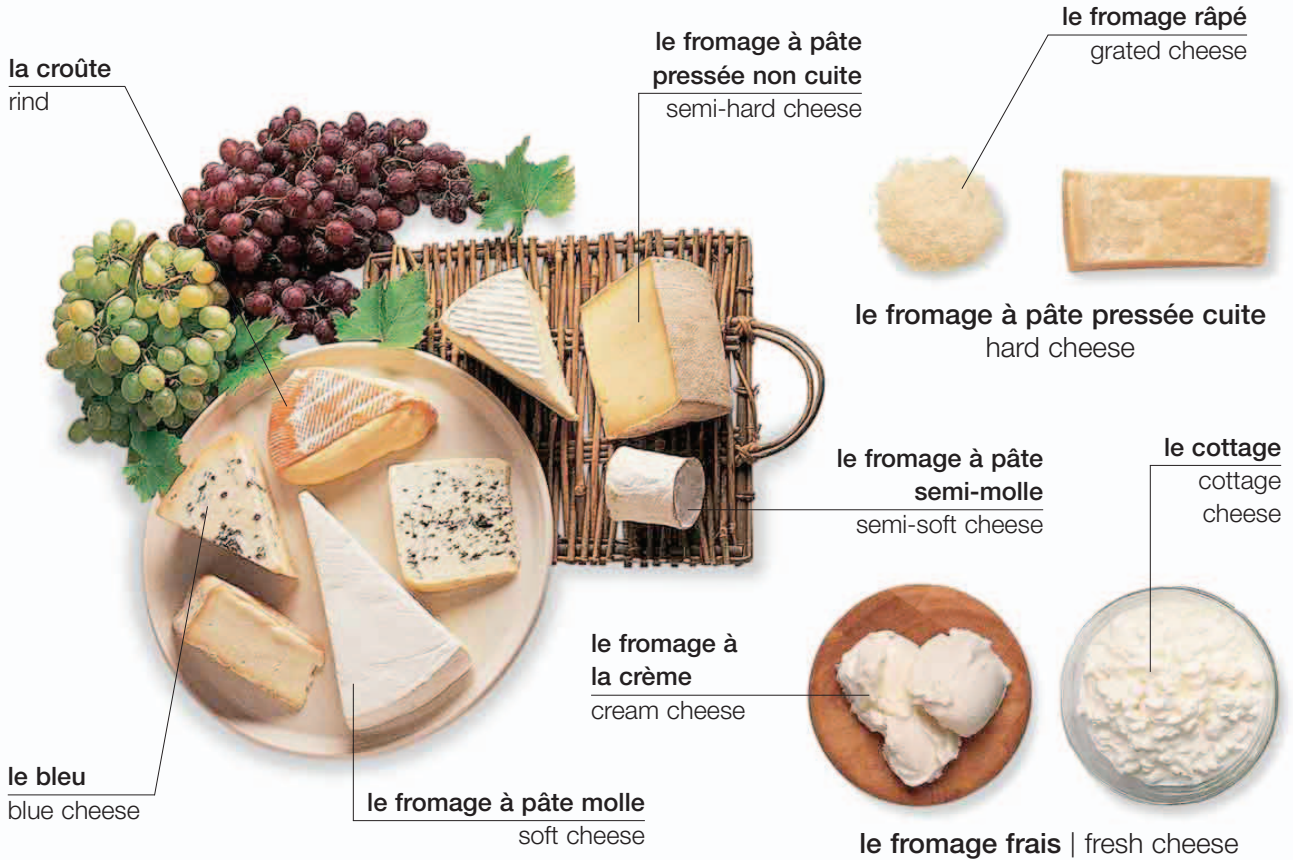

## le lait • milk





**le beurre**  
butter



**la margarine**  
margarine



**la crème**  
cream



**la crème allégée**  
light cream



**la crème épaisse**  
heavy cream



**la crème fouettée**  
whipped cream



**la crème fraîche**  
sour cream



**le yaourt**  
yogurt



**la glace**  
ice cream

**les œufs • eggs**



**l'œuf de poule**  
hen's egg



**l'œuf de cane**  
duck egg



**l'œuf d'oie**  
goose egg



**l'œuf de caille**  
quail egg

**vocabulaire • vocabulary**

<b>pasteurisé</b> pasteurized	<b>le milk-shake</b> milkshake	<b>salé</b> salted	<b>le lait de brebis</b> sheep's milk	<b>le lactose</b> lactose	<b>homogénéisé</b> homogenised
<b>non pasteurisé</b> unpasteurized	<b>le yaourt surgelé</b> frozen yogurt	<b>non salé</b> unsalted	<b>le babeurre</b> buttermilk	<b>sans matières grasses</b> fat-free	<b>le lait en poudre</b> powdered milk

# les pains et la farine • breads and flours

le pain tranché  
sliced bread

les graines de pavot  
poppy seeds

le pain de seigle  
rye bread

la baguette  
baguette



la boulangerie | bread shop

## faire du pain • making bread



la farine blanche  
white flour



la farine complète  
brown flour



la farine brute  
wholemeal flour



la levure  
yeast



tamiser | sift (v)



mélanger | mix (v)

la pâte  
dough



faire cuire au four | bake (v)





la croûte  
crust

**le pain blanc**  
white bread



le pain  
loaf

**le pain bis**  
brown bread



**le pain de son**  
whole-wheat bread

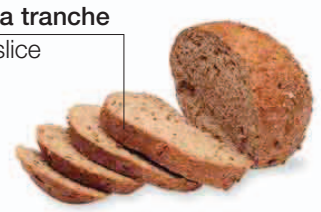

la tranche  
slice

**le pain complet**  
multigrain bread



**le pain de maïs**  
corn bread



**le pain au bicarbonate  
de soude**  
soda bread



**le pain au levain**  
sourdough bread



**le pain plat**  
flatbread



**le petit pain américain**  
bagel



**le petit pain rond**  
bun



**le petit pain**  
roll



**le pain aux raisins secs**  
fruit bread



**le pain aux graines**  
seeded bread



**le naan**  
naan bread



**le pita**  
pita bread

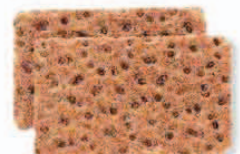

**le biscuit scandinave**  
crispbread

**vocabulaire** • vocabulary

**la farine traitée**  
bread flour

**se lever**  
rise (v)

**lever**  
prove (v)

**la chapelure**  
breadcrumbs

**la machine à couper**  
slicer

**la farine avec la  
levure**  
self-rising flour

**la farine sans  
levure**  
all-purpose  
flour

**glacer**  
glaze (v)

**la flûte**  
flute

**le boulanger**  
baker

# les gâteaux et les desserts • cakes and desserts



**l'éclair**  
éclair

**la pâte à choux**  
choux pastry

**la crème**  
cream

**la pâte feuilletée**  
puff pastry

**la garniture**  
filling

**la pâte de filo**  
phyllo pastry



**le cake**  
fruitcake

**enrobé de chocolat**  
chocolate-coated

**la tarte aux fruits**  
fruit tart

**le muffin**  
muffin

**la meringue**  
meringue

**la madeleine**  
sponge cake

les gâteaux | cakes

## vocabulaire • vocabulary

**la crème pâtissière**  
crème pâtisserie

**le petit gâteau**  
sweet bun

**la pâte**  
pastry

**le riz au lait**  
rice pudding

**Est-ce que je peux  
avoir une tranche s'il  
vous plaît?**

**le gâteau au chocolat**  
chocolate cake

**la crème anglaise**  
custard

**la tranche**  
slice

**la fête**  
celebration

May I have a slice,  
please?

**les pépites de chocolat**  
chocolate chip



**les boudoirs**  
lady fingers



**le florentine**  
florentine

**le diplomate**  
trifle

**les biscuits | cookies**



**la mousse**  
mousse



**le sorbet**  
sherbet



**la tarte à la crème**  
cream pie



**la crème caramel**  
crème caramel

**les gâteaux de fête • celebration cakes**

**l'étage supérieur**  
top tier

**le ruban**  
ribbon

**l'étage inférieur**  
bottom tier

**le glaçage**  
frosting

**la pâte d'amandes**  
marzipan



**le gâteau de mariage | wedding cake**

**la décoration**  
decoration

**les bougies d'anniversaire**  
birthday candles

**souffler**  
blow out (v)



**le gâteau d'anniversaire | birthday cake**

# la charcuterie • delicatessen

**le saucisson piquant**  
spicy sausage

**l'huile**  
oil



**le salami**  
salami

**le pepperoni**  
pepperoni

**le vinaigre**  
vinegar

**la viande non cuite**  
uncooked meat

**le comptoir**  
counter

**la quiche**  
quiche



**le pâté**  
pâté



**la mozzarella**  
mozzarella



**le brie**  
brie



**le fromage de chèvre**  
goat's cheese



**le cheddar**  
cheddar



**le parmesan**  
parmesan



**le camembert**  
camembert

**la croûte**  
rind



**l'édam**  
edam



**le manchego**  
manchego



**les pâtés en croûte**  
meat pies

**l'olive noire**  
black olive

**le piment**  
chili  
pepper

**la sauce**  
sauce



**le petit pain**  
bread roll

**la viande cuite**  
cooked meat



**l'olive verte**  
green olive

**le comptoir sandwiches**  
sandwich counter

**le jambon**  
ham



**le poisson fumé**  
smoked fish



**les câpres**  
capers

**vocabulaire** • vocabulary

**à l'huile**  
in oil

**mariné**  
marinated

**fumé**  
smoked

**en saumure**  
in brine

**salé**  
salted

**séché**  
cured

**Prenez un numéro, s'il vous plaît.**  
Take a number, please.

**Est-ce que je peut goûter un peu de ça, s'il vous plaît?**  
Can I try some of that, please?

**Je voudrais six tranches, s'il vous plaît.**  
May I have six slices of that, please?

**le chorizo**  
chorizo



**le prosciutto**  
prosciutto



**l'olive fourrée**  
stuffed olive

# les boissons • drinks

## l'eau • water

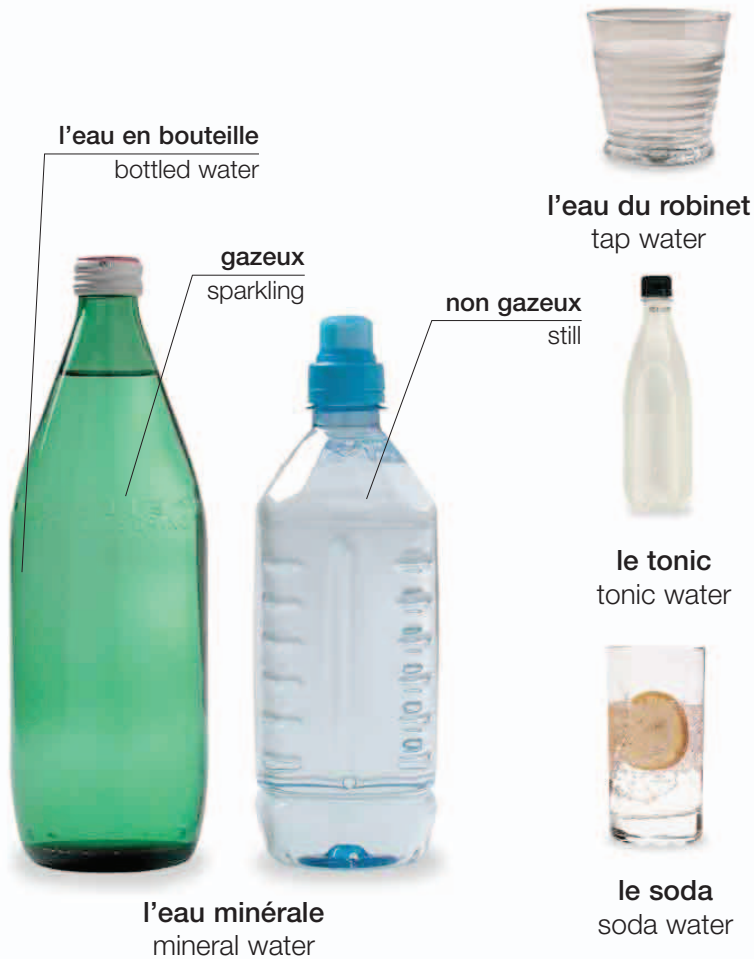

## les boissons chaudes • hot drinks



## les boissons non alcoolisées • soft drinks



les boissons alcoolisées • alcoholic drinks



le gin  
gin



la boîte  
can

la bière  
beer



le cidre  
cider



la bière anglaise  
bitter



la bière brune  
stout



la vodka  
vodka



le whisky  
whiskey



le rhum  
rum



le brandy  
brandy



le porto  
port



sec  
dry

le sherry  
sherry



le campari  
campari

rosé  
rosé

blanc  
white

rouge  
red



la liqueur  
liqueur



la téquila  
tequila



le champagne  
champagne



le vin  
wine



le vin  
wine





**sortir manger**  
eating out

# le café • café



le menu  
menu

le store  
awning

la terrasse de café | sidewalk café



le parasol  
umbrella

la terrasse de café  
terrace café

le serveur  
waiter

le percolateur  
coffee machine

la table  
table



le snack | snack bar

# le café • coffee

le crème  
coffee with  
milk

le noir  
black coffee

le chocolat en  
poudre  
cocoa powder

la mousse  
froth



le café filtre  
filter coffee



l'expresso  
espresso



le cappuccino  
cappuccino



le café glacé  
iced coffee

**le thé • tea**

la tisane  
herbal tea



le thé au lait  
tea with milk

le thé nature  
plain tea



la camomille  
chamomile tea



le thé au citron  
tea with lemon



l'infusion de menthe  
mint tea



le thé vert  
green tea



le thé glacé  
iced tea

**les jus et milk-shakes • juices and milkshakes**



le jus  
d'orange  
orange juice



le jus de  
pomme  
apple juice



le jus  
d'ananas  
pineapple juice



le jus de  
tomate  
tomato juice

le milk-shake au chocolat  
chocolate milkshake

le milk-shake à la  
fraise  
strawberry milkshake

le milk-shake au  
café  
coffee milkshake



**la nourriture • food**

le pain bis  
brown bread

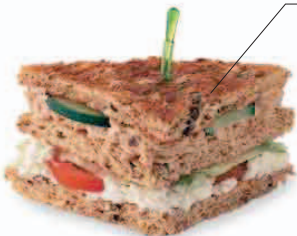

le sandwich grillé  
toasted sandwich



la salade  
salad



la glace  
ice cream

la boule  
scoop



la pâtisserie  
pastry

# le bar • bar

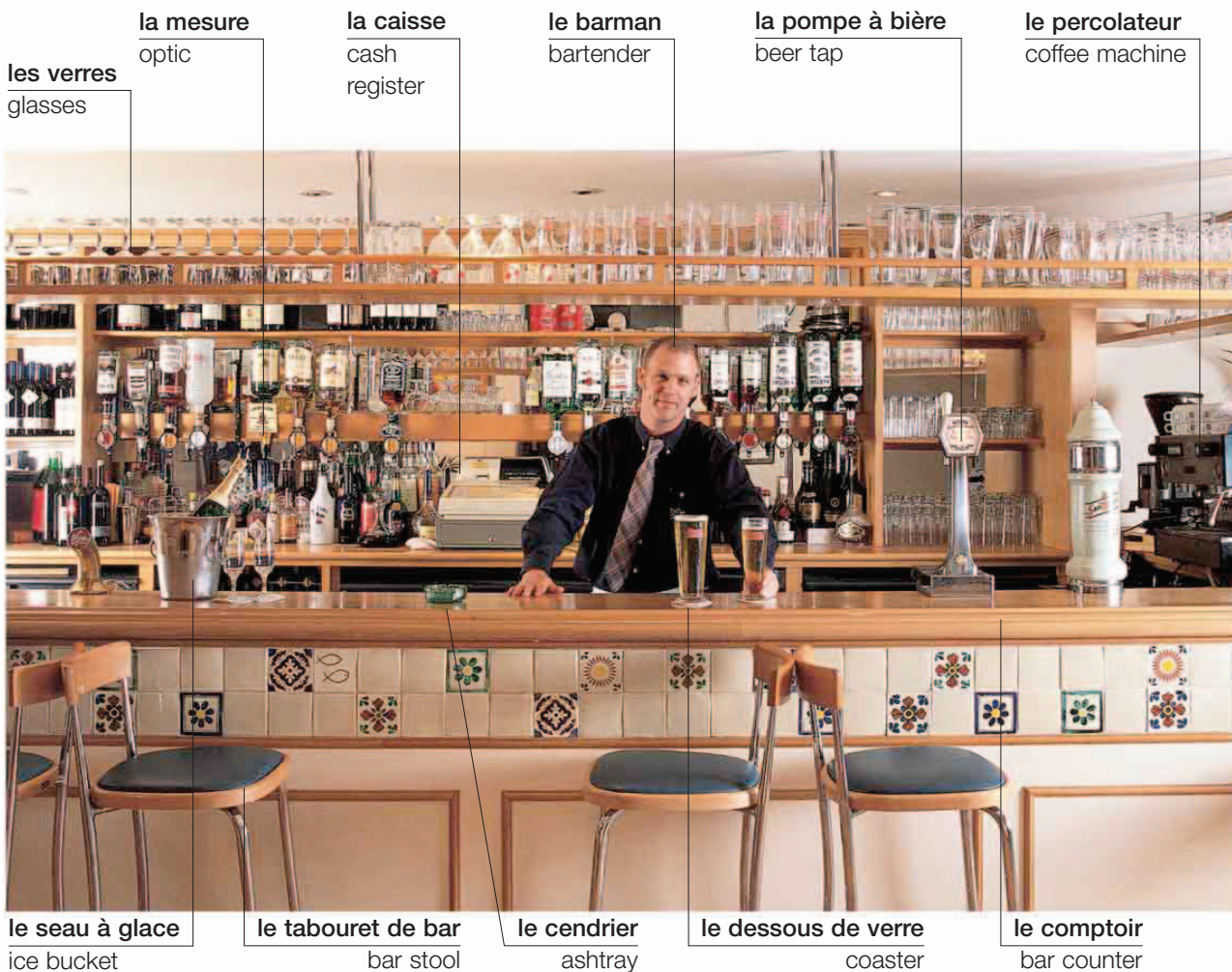

**l'ouvre-bouteille**  
bottle opener



**le levier**  
lever

**le tire-bouchon** | corkscrew

**les pinces**  
tongs

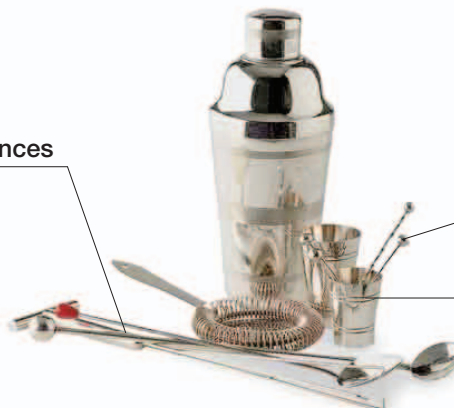

**l'agitateur**  
stirrer

**le verre gradué**  
mesure

**le shaker à cocktails** | cocktail shaker





**le gin tonic**  
gin and tonic

**le pichet**  
pitcher



**le scotch à l'eau**  
scotch and water



**le glaçon**  
ice cube

**le rhum coca**  
rum and cola



**la vodka à l'orange**  
screwdriver



**le martini**  
martini



**le cocktail**  
cocktail



**le vin**  
wine



**la bière** | beer



**un coup**  
shot

**simple**  
single



**la mesure**  
measure

**double**  
double



**sans glaçons**  
without ice

**citron et glaçons**  
ice and lemon



**avec des glaçons**  
with ice

**les amuse-gueule • bar snacks**



**les chips** | chips

**les noix de cajou**  
cashews

**les amandes**  
almonds



**les noix** | nuts

**les cacahouètes**  
peanuts



**les olives** | olives

# le restaurant • restaurant

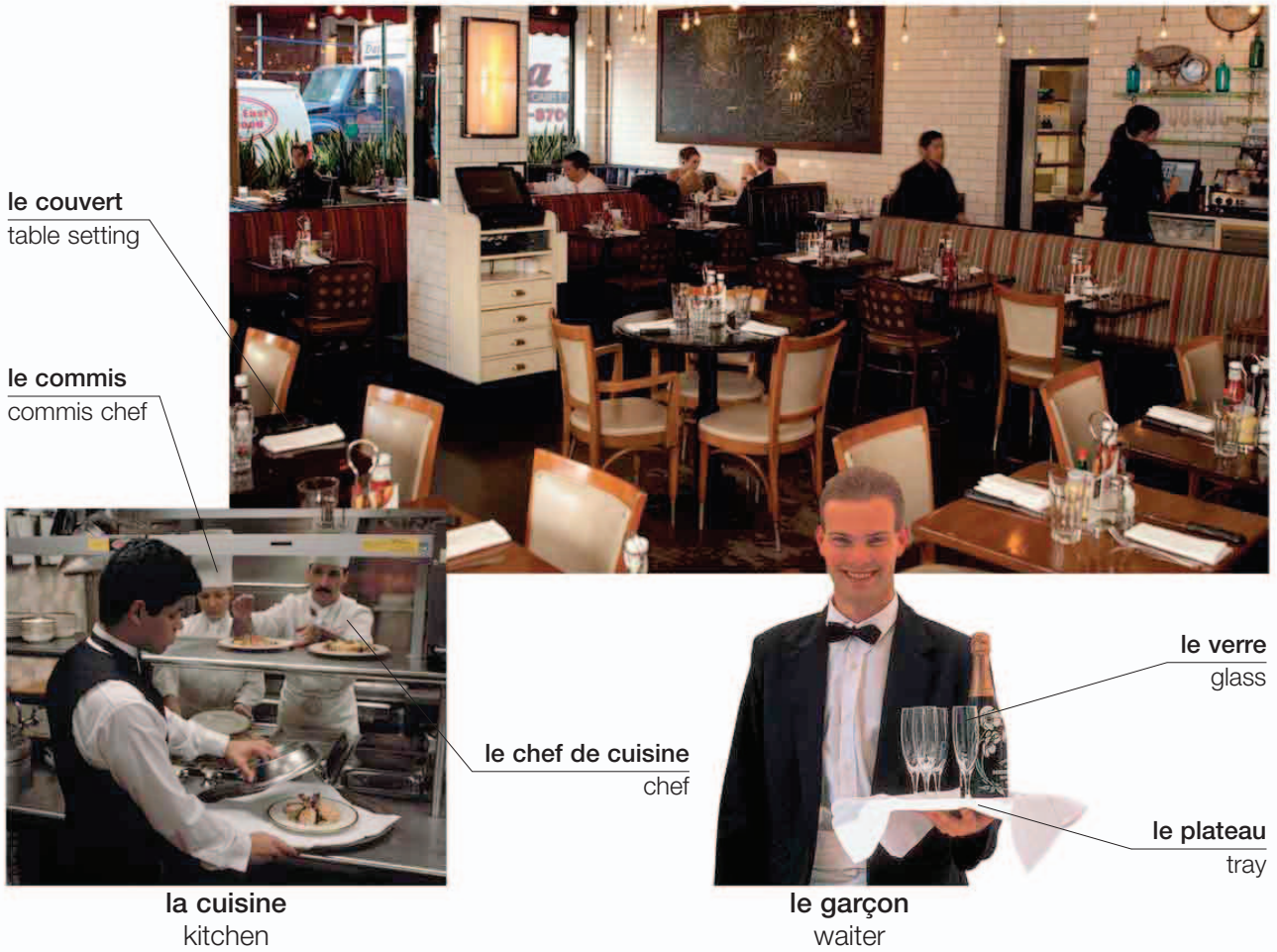

**le couvert**  
table setting

**le commis**  
commis chef

**le chef de cuisine**  
chef

**le verre**  
glass

**le plateau**  
tray

**la cuisine**  
kitchen

**le garçon**  
waiter

## vocabulaire • vocabulary

<b>le menu du soir</b> evening menu	<b>les spécialités</b> specials	<b>le prix</b> price	<b>le pourboire</b> tip	<b>le buffet</b> buffet	<b>le client</b> customer
<b>la carte des vins</b> wine list	<b>à la carte</b> à la carte	<b>l'addition</b> check	<b>service compris</b> service included	<b>le bar</b> bar	<b>le poivre</b> pepper
<b>le menu du déjeuner</b> lunch menu	<b>le plateau de desserts</b> dessert cart	<b>le reçu</b> receipt	<b>service non compris</b> service not included	<b>le sel</b> salt	



la carte  
menu



le menu d'enfant  
children's meal



commander  
order (v)



payer  
pay (v)

les plats • courses



l'apéritif  
apéritif



l'entrée  
appetizer



la soupe  
soup



le plat principal  
entrée



l'accompagnement  
side order



le dessert | dessert



le café | coffee

**Une table pour deux, s'il vous plaît.**

A table for two, please.

**La carte/la carte des vins, s'il vous plaît.**

Can I see the menu/wine list, please?

**Avez-vous un menu à prix fixe?**

Is there a fixed-price menu?

**Avez vous des plats végétariens?**

Do you have any vegetarian dishes?

**L'addition/un reçu, s'il vous plaît.**

Could I have the check/a receipt, please?

**Pouvons-nous payer chacun notre part?**

Can we pay separately?

**Où sont les toilettes, s'il vous plaît?**

Where are the restrooms, please?

# la restauration rapide • fast food

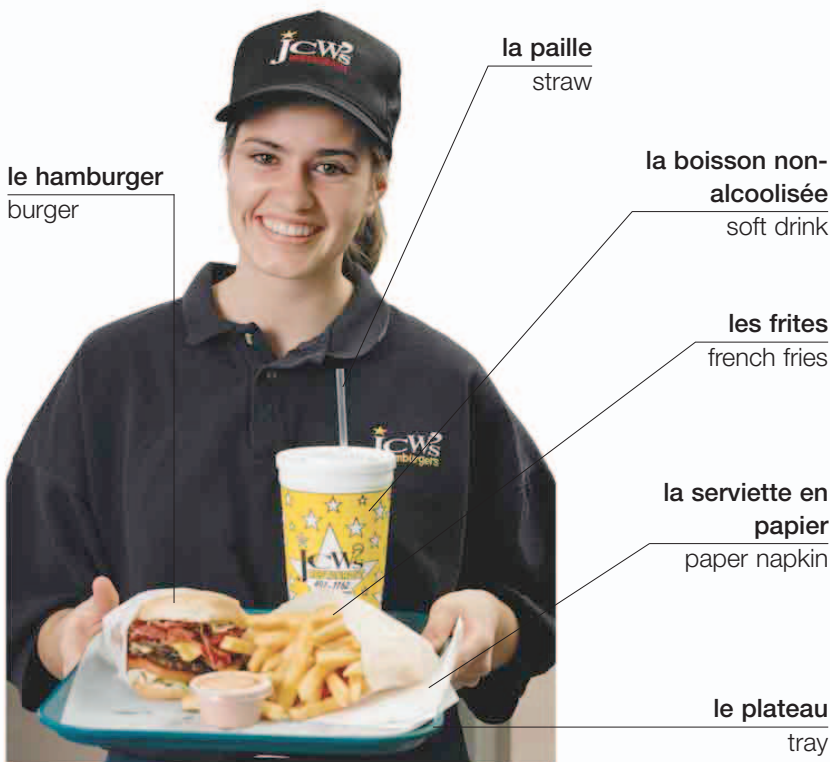

le hamburger  
burger

la paille  
straw

la boisson non-  
alcoolisée  
soft drink

les frites  
french fries

la serviette en  
papier  
paper napkin

le plateau  
tray

le hamburger avec des frites  
burger meal



la pizza  
pizza

le tarif  
price list

la livraison à domicile  
home delivery



la boisson en boîte  
canned drink

le marchand de hot-dogs  
hot dog vendor

## vocabulaire • vocabulary

la pizzeria  
pizzeria

le restaurant rapide  
burger bar

la carte  
menu

manger sur place  
for here

à emporter  
to go

réchauffer  
reheat (v)

le ketchup  
ketchup

À emporter, s'il vous  
plaît.  
Can I have that to go,  
please?

Est-ce que vous livrez à  
domicile?  
Do you deliver?



**le hamburger**  
hamburger



**le hamburger au poulet**  
chicken burger



**le hamburger végétarien**  
veggie burger

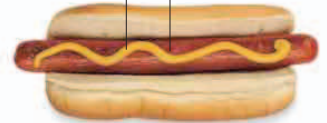

**le hot-dog**  
hot dog

le petit pan  
bun

la moutarde  
mustard

la saucisse  
sausage



**le sandwich**  
sandwich



**le sandwich mixte**  
club sandwich



**le canapé**  
open sandwich

la garniture  
filling



**le taco**  
wrap



**le kébab**  
kebab

la sauce  
sauce



**les beignets de poulet**  
chicken nuggets

salé  
savory



**les crêpes** | crêpes

sucré  
sweet



la garniture  
topping



**le poisson avec des frites**  
fish and chips



**les côtes**  
ribs



**le poulet frit**  
fried chicken



**la pizza**  
pizza

# le petit déjeuner • breakfast

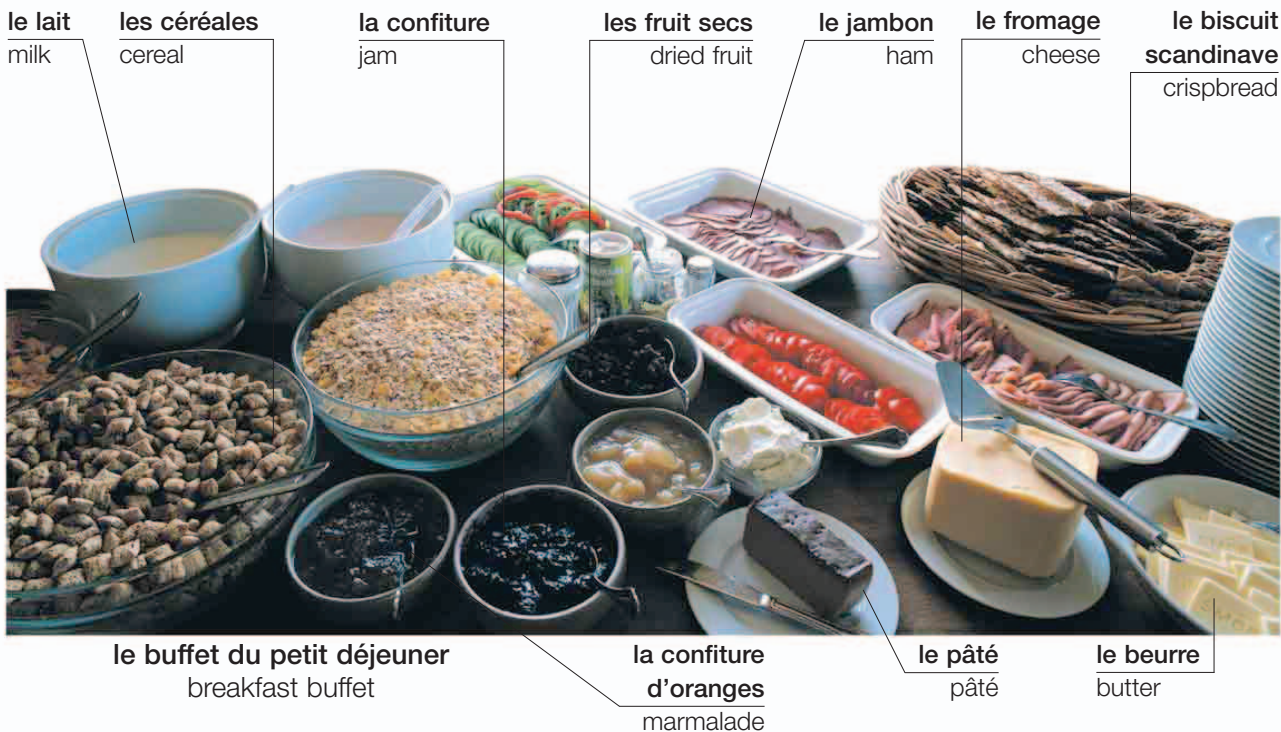

la table du petit déjeuner | breakfast table



les boissons | drinks



**la brioche**  
brioche



**le pain**  
bread

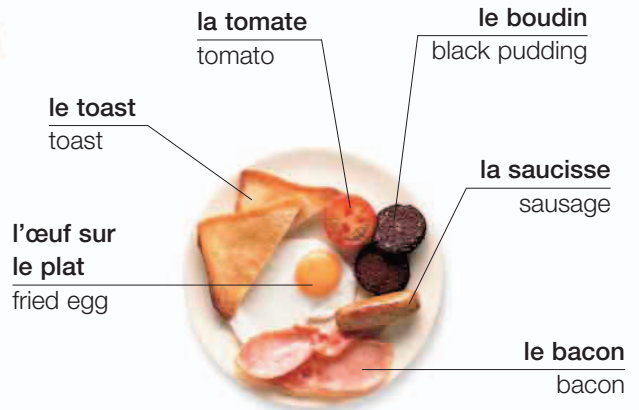

**le toast**  
toast

**la tomate**  
tomato

**le boudin**  
black pudding

**la saucisse**  
sausage

**l'œuf sur le plat**  
fried egg

**le bacon**  
bacon

**le petit déjeuner anglais**  
English breakfast



**les kippers**  
kippers



**le pain perdu**  
French toast

**le jaune d'œuf**  
yolk



**l'œuf à la coque**  
boiled egg



**les œufs brouillés**  
scrambled eggs

**la crème**  
cream



**les crêpes**  
crêpes

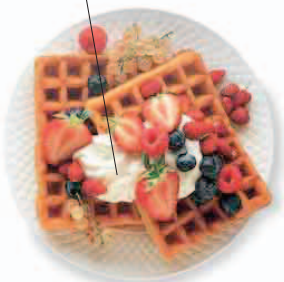

**les gaufres**  
waffles

**le yaourt aux fruits**  
fruit yogurt



**le porridge**  
oatmeal



**les fruits**  
fresh fruit

# le repas • dinner



**le potage** | soup



**le bouillon** | broth



**le ragoût** | stew



**le curry** | curry



**le rôti**  
roast



**la tourte**  
pie



**le soufflé**  
soufflé



**le chiche-kébab**  
kebab



**les boulettes de viande**  
meatballs



**l'omelette**  
omelet



**le sauté** | stir fry

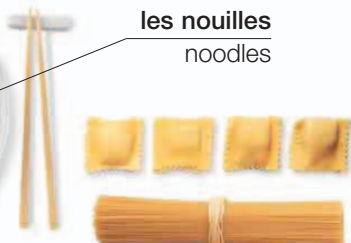

**les nouilles**  
noodles

**les pâtes** | pasta



**le riz**  
rice



**la salade composée**  
tossed salad



**la salade verte**  
green salad



**la vinaigrette**  
dressing



la préparation • techniques



**farc** | stuffed



**en sauce** | in sauce



**grillé** | grilled



**mariné** | marinated



**poché** | poached



**en purée** | mashed



**cuit** | baked



**sauté** | pan-fried



**frit**  
fried



**macéré**  
pickled



**fumé**  
smoked



**frit**  
deep fried



**au sirop**  
in syrup



**assaisonné**  
dressed



**cuit à la vapeur**  
steamed



**séché**  
cured



A close-up photograph of several parallel red metal strips, possibly part of a mechanical assembly or a book binding. Each strip is secured with a silver-colored rivet. The strips are set against a solid red background. A semi-transparent white horizontal band is overlaid across the middle of the image.

**l'étude**  
study

# l'école • school



## vocabulaire • vocabulary

**l'histoire**  
history

**les sciences**  
science

**la physique**  
physics

**les langues**  
languages

**l'art/le dessin**  
art

**la chimie**  
chemistry

**la littérature**  
literature

**la musique**  
music

**la biologie**  
biology

**la géographie**  
geography

**les mathématiques**  
math

**l'éducation physique**  
physical education

## les activités • activities



**lire** | read (v)



**écrire** | write (v)



**épeler**  
spell (v)



**dessiner**  
draw (v)



**le projecteur numérique**  
digital projector



**le stylo**  
pen



**le crayon**  
pencil

**le crayon de couleur**  
colored pencil



**le taille-crayon**  
pencil sharpener

**le cahier**  
notebook



**le livre** | textbook



**la trousse**  
pencil case



**la gomme**  
eraser



**la règle**  
ruler



**questionner**  
question (v)



**répondre**  
answer (v)



**discuter**  
discuss (v)



**apprendre**  
learn (v)

**vocabulaire** • vocabulary

**le directeur**  
principal

**la réponse**  
answer

**la note**  
grade

**la leçon**  
lesson

**les devoirs**  
homework

**la classe**  
year

**la question**  
question

**l'examen**  
test

**le dictionnaire**  
dictionary

**prendre des notes**  
take notes (v)

**la rédaction**  
essay

**l'encyclopédie**  
encyclopedia

# les mathématiques • math

## les formes • shapes

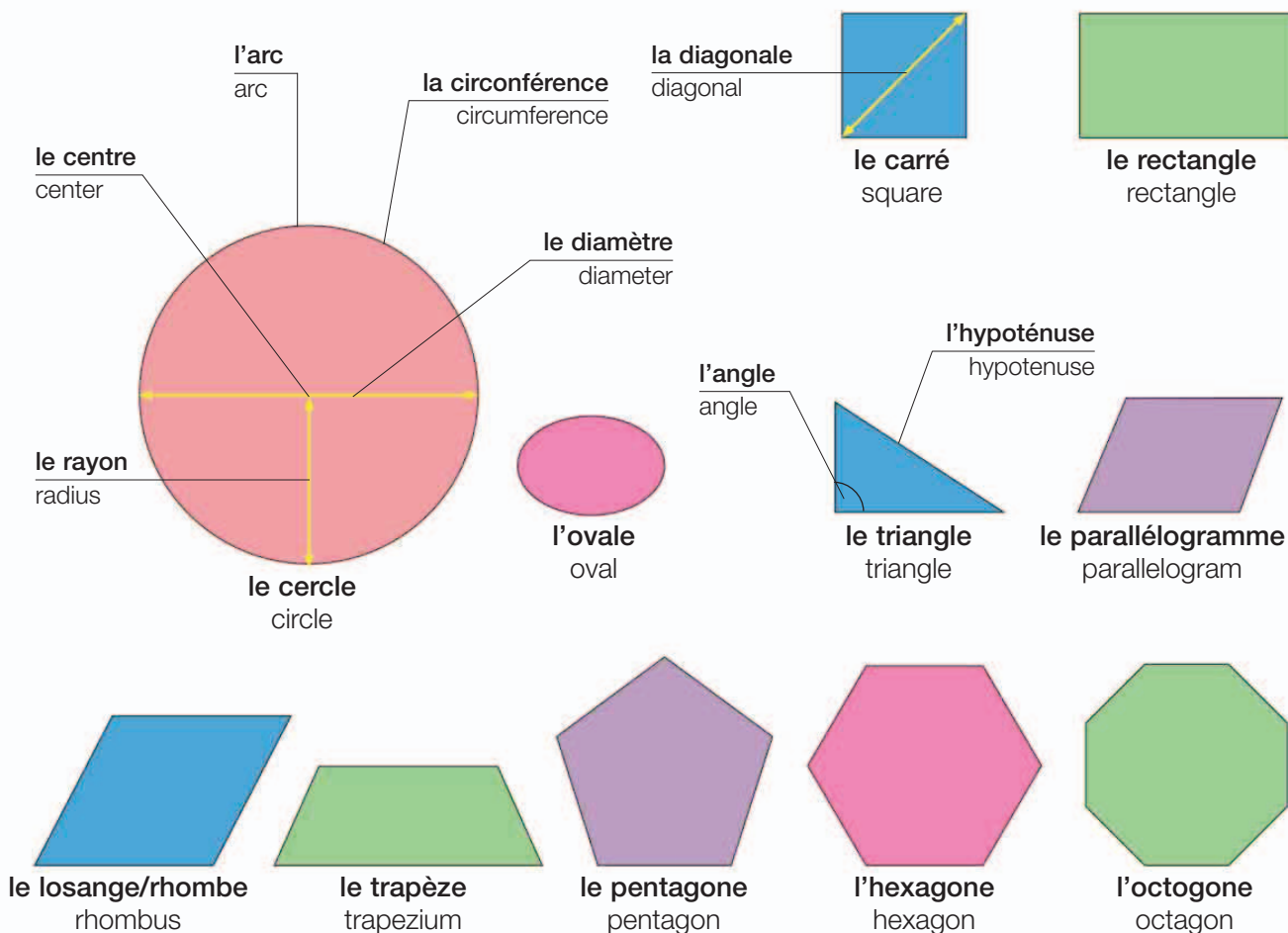

## les solides • solids

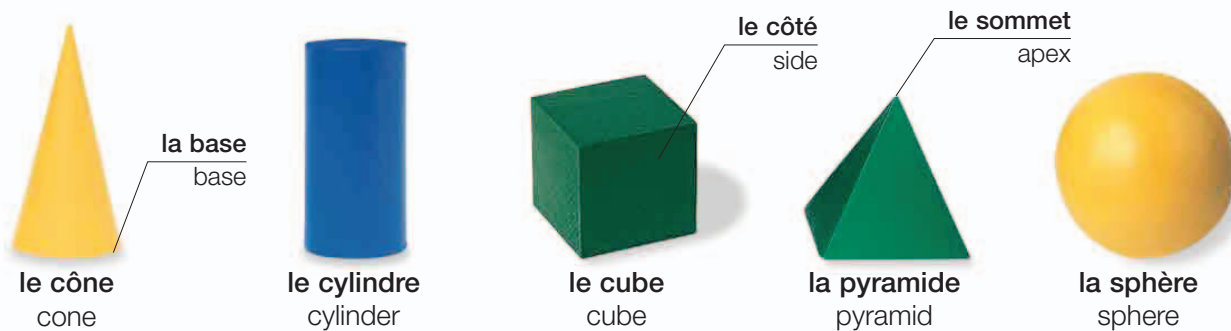

## les lignes • lines



## les mesures • measurements

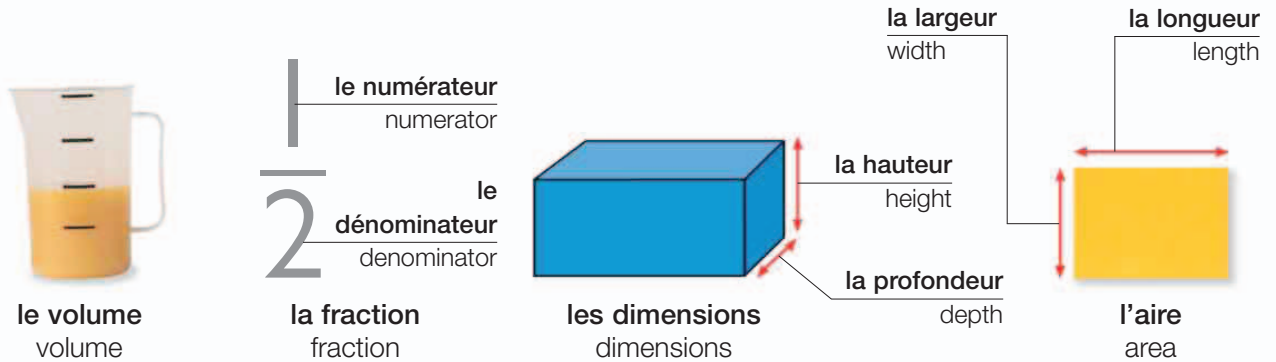

## l'équipement • equipment

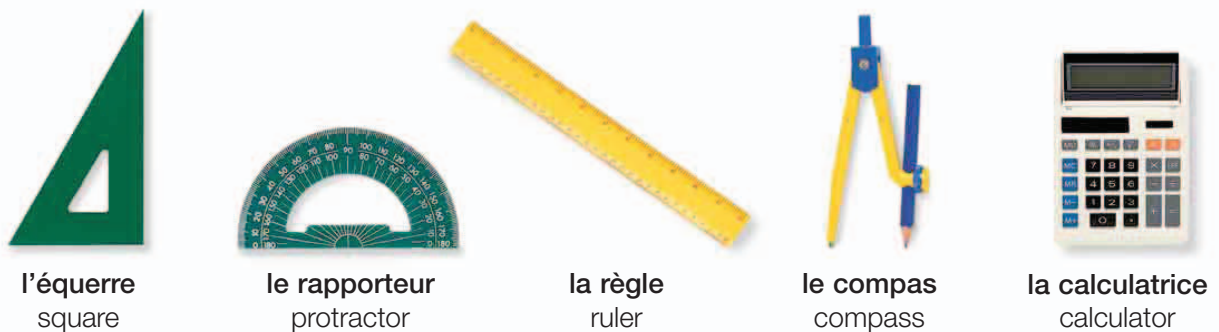

## vocabulaire • vocabulary

la géométrie geometry	plus plus	fois times	égale(nt) equals	additionner add (v)	multiplier multiply (v)	l'équation equation
l'arithmétique arithmetic	moins minus	divisé par divided by	compter count (v)	soustraire subtract (v)	diviser divide (v)	le pourcentage percentage

# la science • science



**le laboratoire**  
laboratory

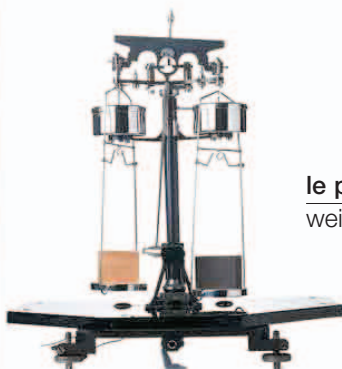

**la balance**  
scales



**le poids**  
weight

**la balance à ressort**  
spring balance

**le creuset**  
crucible



**le bec Bunsen**  
bunsen burner

**le trépied**  
tripod



**la bouteille**  
glass bottle

**l'entonnoir**  
funnel

**la fiole**  
flask

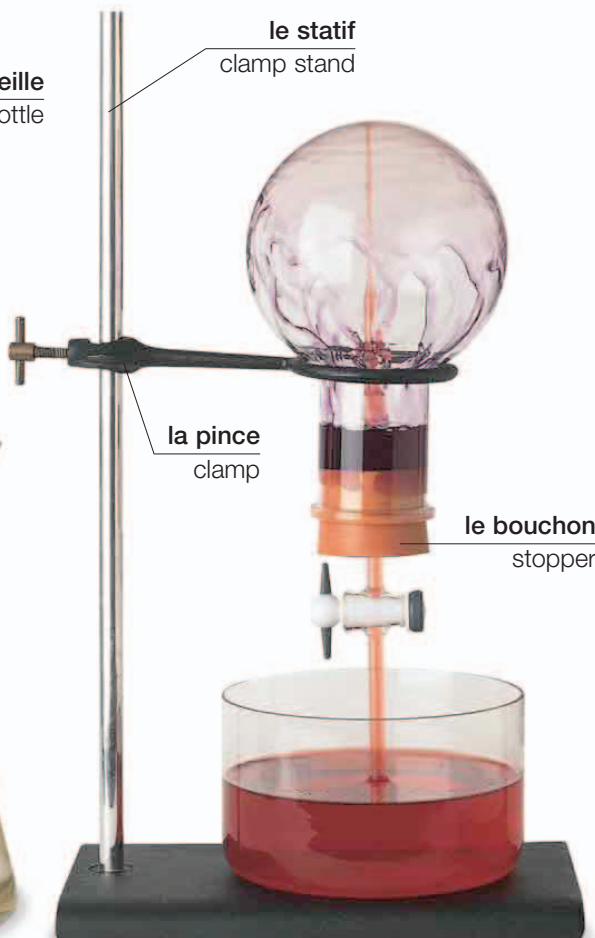

**le statif**  
clamp stand

**la pince**  
clamp

**le bouchon**  
stopper

**l'expérience** | experiment

**l'éprouvette**  
test tube



**le support**  
rack



**le chronomètre**  
timer



**la boîte de Pétri**  
petri dish





**le thermomètre**  
thermometer



**la seringue**  
syringe



**la pince fine**  
tweezers



**le scalpel**  
scalpel



**le compte-gouttes**  
dropper



**le forceps** | forceps



**la pince**  
tongs



**la spatule**  
spatula

**le pilon**  
pestle



**le mortier**  
mortar



**le papier filtre**  
filter paper



**les lunettes de protection**  
safety goggles

**l'oculaire**  
eyepiece

**le bouton de mise au point**  
focusing knob



**la lentille de l'objectif**  
objective lens

**la platine**  
stage

**le porte-objet**  
slide

**le miroir**  
mirror

**le microscope** | microscope

**la tige de verre**  
glass stirrer



**la pipette**  
pipette

**le bécher**  
beaker



**l'aimant**  
magnet



**la pince crocodile**  
alligator clip

**l'électrode négative**  
negative electrode



**l'électrode positive**  
positive electrode

**la pile** | battery

# l'enseignement supérieur • college



**le secrétariat**  
admissions  
office

**le restaurant universitaire**  
cafeteria

**le service de santé**  
clinic

**le terrain de sport**  
sports field

**la résidence universitaire**  
residence hall

**le campus** | campus

## vocabulaire • vocabulary

**la carte de lecteur**  
library card

**les renseignements**  
help desk

**le prêt**  
loan

**la salle de lecture**  
reading room

**emprunter**  
borrow (v)

**le livre**  
book

**les ouvrages recommandés**  
reading list

**réserver**  
reserve (v)

**le titre**  
title

**la date de retour**  
due date

**renouveler**  
renew (v)

**le couloir**  
aisle

**la bibliothécaire**  
librarian

**le service de prêt**  
circulation desk

**les rayons**  
bookshelves

**le périodique**  
periodical

**la revue**  
journal

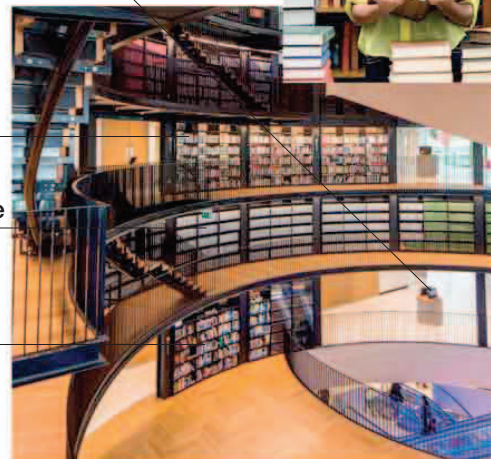

**la bibliothèque** | library

**l'étudiant**  
undergraduate

**l'assistant**  
professor



**la salle de cours**  
lecture hall

**la licenciée**  
graduate

**la robe**  
robe



**la cérémonie de la remise des diplômes**  
graduation ceremony

## les écoles • schools



**le modèle**  
model

**l'école des beaux arts**  
art college



**le Conservatoire**  
music school



**l'école de danse**  
dance academy

## vocabulaire • vocabulary

**la bourse**  
scholarship

**la recherche**  
research

**la dissertation**  
dissertation

**la médecine**  
medicine

**la philosophie**  
philosophy

**le diplôme**  
diploma

**la maîtrise**  
master's  
degree

**l'U.F.R.**  
department

**la zoologie**  
zoology

**la littérature**  
literature

**la licence**  
degree

**le doctorat**  
doctorate

**le droit**  
law

**la physique**  
physics

**l'histoire d'art**  
art history

**de troisième  
cycle**  
postgraduate

**la thèse**  
thesis

**les études  
d'ingénieur**  
engineering

**les sciences  
politiques**  
politics

**les sciences  
économiques**  
economics



[WWW.EBOOK777.COM](http://WWW.EBOOK777.COM)



**le travail**  
work

[WWW.EBOOK777.COM](http://WWW.EBOOK777.COM)

# le bureau 1 • office 1



## l'équipement de bureau • office equipment

le magasin à papier  
paper tray



l'imprimante | printer



le fax | fax machine

### vocabulaire • vocabulary

imprimer  
print (v)

agrandir  
enlarge (v)

photocopier  
copy (v)

réduire  
reduce (v)

J'ai besoin de faire des photocopies.  
I need to make some copies.

les fournitures de bureau • office supplies

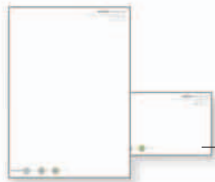

**l'en-tête**  
stationery

**la fiche compliments**  
notecard



**l'enveloppe**  
envelope

**le dossier-classeur**  
box file



**le classeur à levier**  
ring binder



**le clipboard**  
clipboard



**le bloc-notes**  
notepad



**l'étiquette**  
tab

**le dossier suspendu**  
hanging file

**la fiche intercalaire**  
divider



**le porte-dossiers**  
expanding file



**l'agenda**  
personal organizer

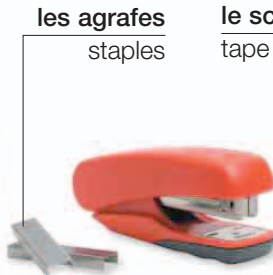

**les agrafes**  
staples

**l'agrafeuse**  
stapler

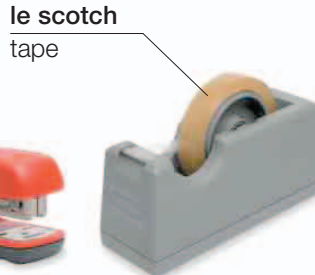

**le scotch**  
tape

**le dévidoir de scotch**  
tape dispenser



**le perforateur**  
hole punch



**le tampon encreur**  
ink pad

**le cachet**  
rubber stamp



**l'élastique**  
rubber band



**la pince à dessin**  
bulldog clip



**le trombone**  
paper clip

**la punaise**  
thumbtack



**le panneau d'affichage** | notice board

## le bureau 2 • office 2

**le tableau à feuilles mobiles**  
flipchart

**le compte rendu**  
minutes

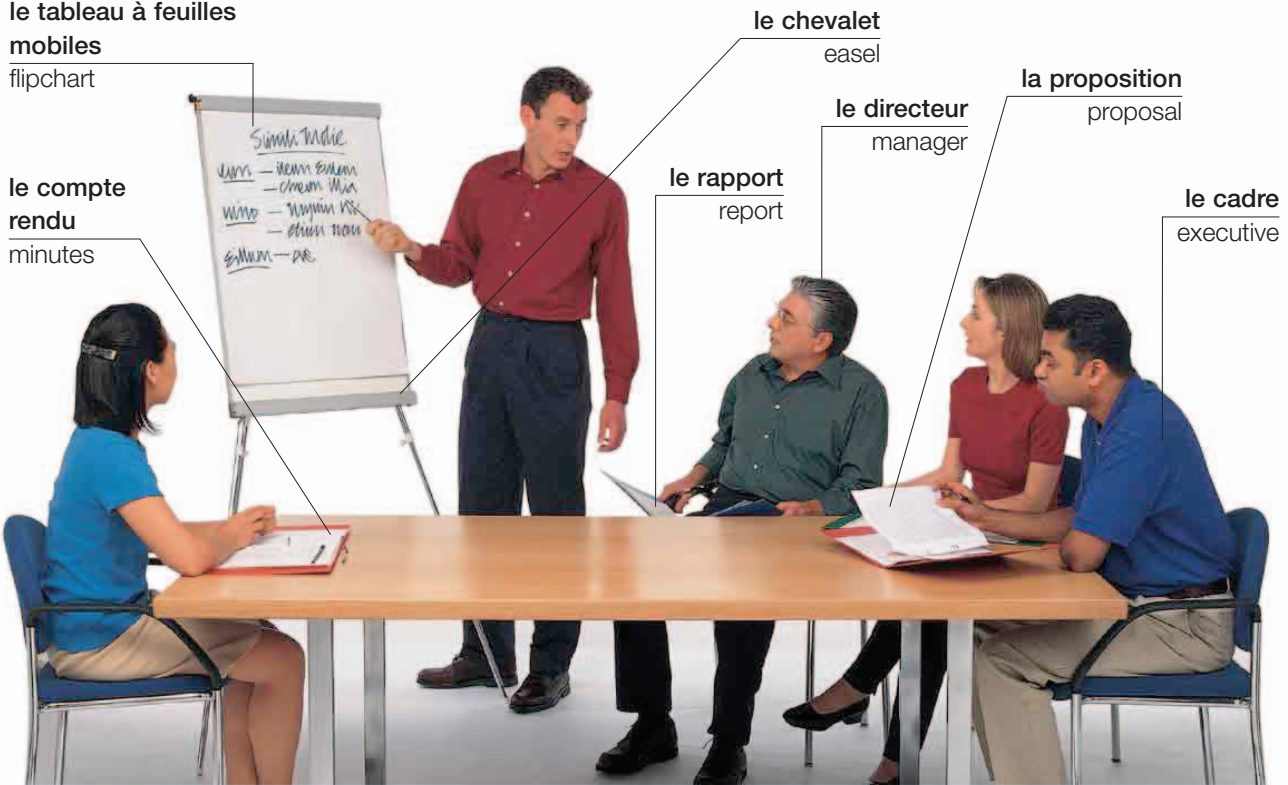

**le chevalet**  
easel

**le directeur**  
manager

**la proposition**  
proposal

**le rapport**  
report

**le cadre**  
executive

le réunion | meeting

### vocabulaire • vocabulary

**la salle de conférence**  
meeting room

**assister à**  
attend (v)

**l'ordre du jour**  
agenda

**présider**  
chair (v)

**La conférence est à quelle heure?**  
What time is the meeting?

**Quelles sont vos heures de bureau?**  
What are your office hours?

**la conférencière**  
speaker



la présentation | presentation



les affaires • business

**l'homme d'affaires**  
businessman

**la femme d'affaires**  
businesswoman



**le déjeuner d'affaires**  
business lunch



**le voyage d'affaires**  
business trip

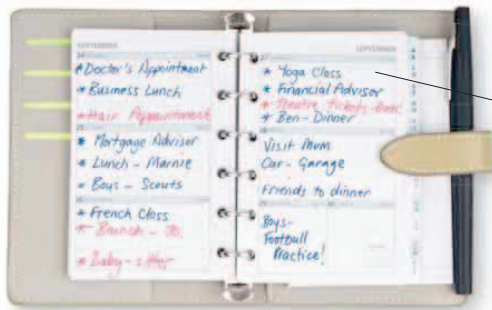

**l'agenda** | organizer

**le rendez-vous**  
appointment

**la cliente**  
client



**le directeur général**  
CEO

**le contrat**  
business deal

**vocabulaire** • vocabulary

**la société**  
company

**le personnel**  
staff

**la comptabilité**  
accounts department

**le service du contentieux**  
legal department

**le siège social**  
headquarters

**le salaire**  
salary

**le service marketing**  
marketing department

**le service après-vente**  
customer service department

**la succursale**  
regional office

**le livre de paie**  
payroll

**le service des ventes**  
sales department

**le service de ressources humaines**  
human resources department

# l'ordinateur • computer

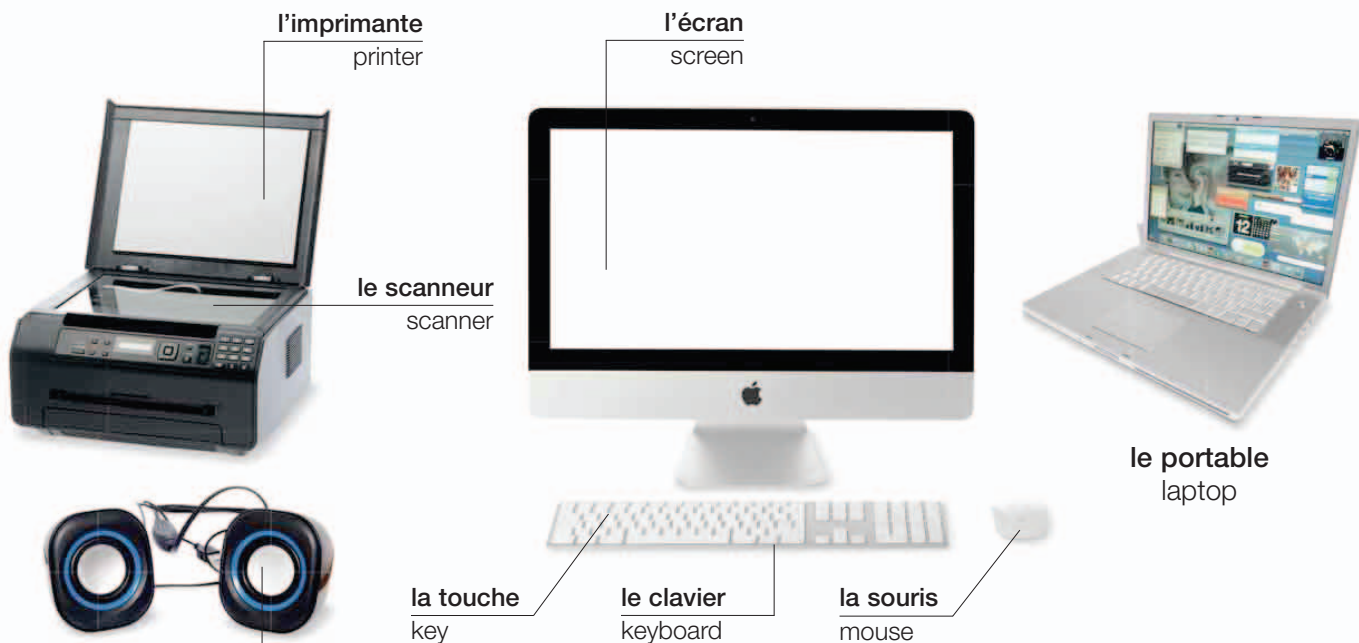

le matériel  
hardware



la clé USB  
memory stick



le disque dur externe  
external hard drive

**vocabulaire • vocabulary**

<b>la mémoire</b> memory	<b>le logiciel</b> software	<b>le serveur</b> server
<b>la RAM</b> RAM	<b>l'application</b> application	<b>le port</b> port
<b>les bytes</b> bytes	<b>le programme</b> program	<b>le processeur</b> processor
<b>le système</b> system	<b>le réseau</b> network	<b>le câble électrique</b> power cord



l'iPad®  
iPad



le smartphone  
smartphone

## le bureau • desktop

la barre de menus  
menu bar

la barre d'outils  
toolbar

le papier peint  
wallpaper

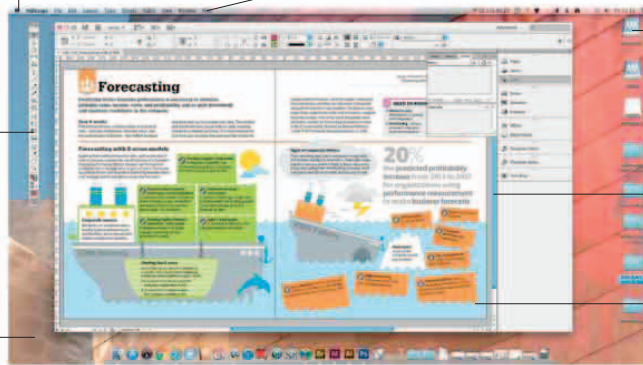

la police  
font

l'icône  
icon

la barre  
de défilement  
scrollbar

la fenêtre  
window



le fichier  
file



le dossier  
folder



la poubelle  
trash

## l'internet • internet

le navigateur  
browser



naviguer  
browse (v)

la boîte de  
réception  
inbox

le site web  
website

## l'e-mail • email

l'adresse e-mail  
email address

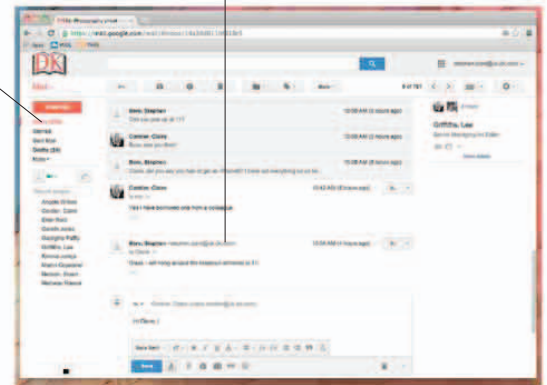

### vocabulaire • vocabulary

connecter  
connect (v)

le fournisseur d'accès  
service provider

entrer  
log on (v)

télécharger  
download (v)

envoyer  
send (v)

sauvegarder  
save (v)

installer  
install (v)

le compte e-mail  
email account

en ligne  
on line

la pièce jointe  
attachment

recevoir  
receive (v)

chercher  
search (v)

# les médias • media

## le studio de télévision • television studio

**le plateau**  
set

**le présentateur**  
presenter

**l'éclairage**  
light



**la caméra**  
camera

**la grue de caméra**  
camera crane

**le cameraman**  
cameraman

### vocabulaire • vocabulary

**la chaîne**  
channel

**les nouvelles**  
news

**la presse**  
press

**le feuilleton**  
soap opera

**le dessin animé**  
cartoon

**en direct**  
live

**la programmation**  
programming

**le documentaire**  
documentary

**la série télévisée**  
television series

**le jeu télévisé**  
game show

**en différé**  
prerecorded

**émettre**  
broadcast (v)



**l'interviewer**  
interviewer



**la reporter**  
reporter



**le télésoffleur**  
teleprompter



**la présentatrice**  
newscaster



**les acteurs**  
actors



**la perche**  
sound boom



**la claquette**  
clapper board



**le décor de cinéma**  
movie set

## la radio • radio

**l'ingénieur du son**  
sound technician

**le pupitre de mixage**  
mixing desk

**le microphone**  
microphone



**le studio d'enregistrement** | recording studio

## vocabulaire • vocabulary

**la station de radio**  
radio station

**la fréquence**  
frequency

**le D.J.**  
DJ

**le volume**  
volume

**l'émission**  
broadcast

**régler**  
tune (v)

**la longueur d'ondes**  
wavelength

**les ondes courtes**  
short wave

**les grandes ondes**  
long wave

**les ondes moyennes**  
medium wave

**analogique**  
analog

**numérique**  
digital

# le droit • law

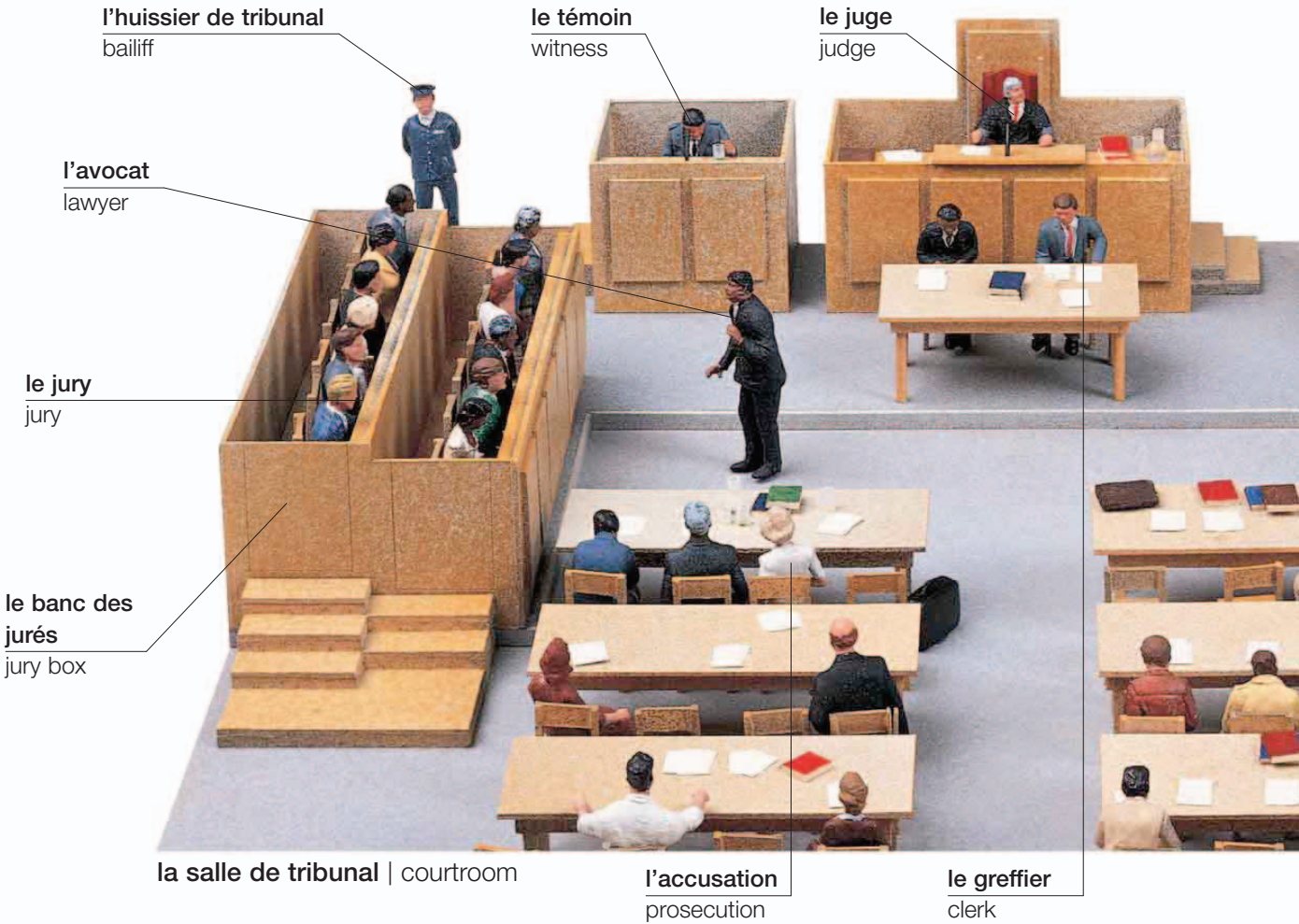

## vocabulaire • vocabulary

**le cabinet**  
lawyer's office

**l'assignation**  
summons

**l'acte judiciaire**  
writ

**la cause**  
court case

**le conseil juridique**  
legal advice

**la déposition**  
statement

**la date du procès**  
court date

**l'accusation**  
charge

**le client**  
client

**le mandat**  
warrant

**le plaidoyer**  
plea

**l'accusé**  
accused

**le sténographe**  
stenographer

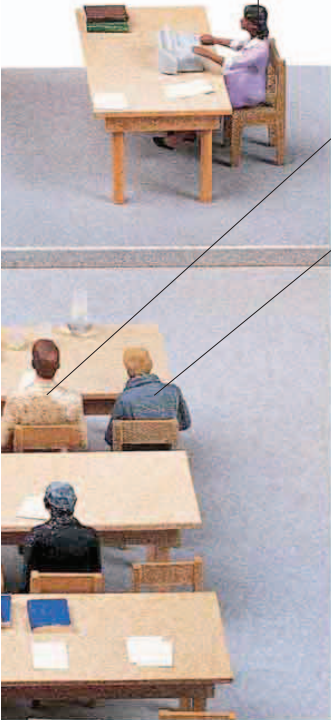

**l'accusé**  
defendant

**la défense**  
defense

**le suspect**  
suspect



**le portrait-robot**  
composite

**le criminel**  
criminal



**le casier judiciaire**  
criminal record



**le gardien de prison**  
prison guard



**la cellule**  
cell

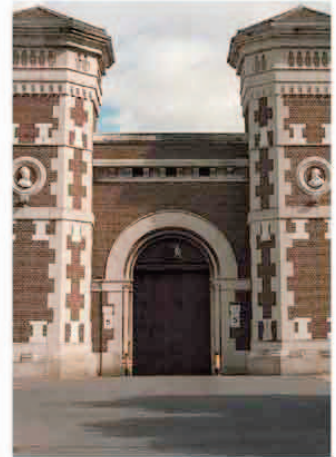

**la prison**  
prison

**vocabulaire** • vocabulary

**la preuve**  
evidence

**coupable**  
guilty

**la caution**  
bail

**Je voudrais voir un avocat.**  
I want to see a lawyer.

**le verdict**  
verdict

**acquitté**  
acquitted

**l'appel**  
appeal

**Où est le palais de justice?**  
Where is the courthouse?

**innocent**  
innocent

**la condamnation**  
sentence

**la liberté conditionnelle**  
parole

**Est-ce que je peux verser la caution?**  
Can I post bail?

# la ferme 1 • farm 1



**l'agriculteur/le fermier**  
farmer

**le potager**  
vegetable garden

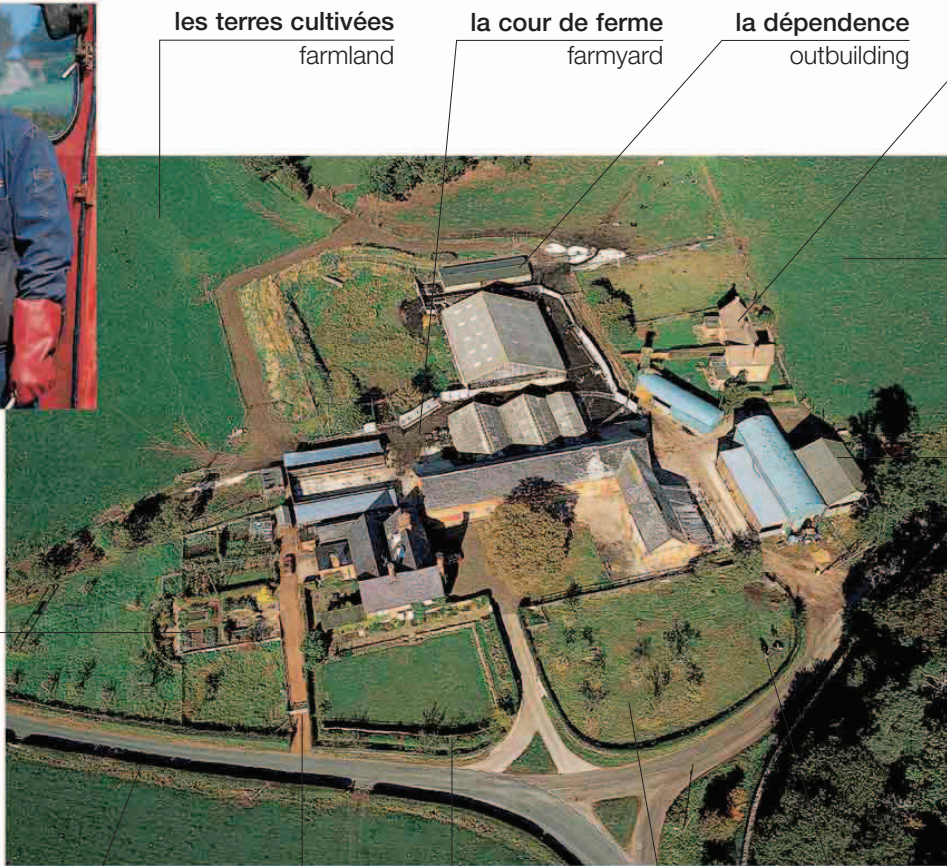

**les terres cultivées**  
farmland

**la cour de ferme**  
farmyard

**la dépendance**  
outbuilding

**la maison d'habitation**  
farmhouse

**le champ**  
field

**la grange**  
barn

**la haie**  
hedge

**la barrière**  
gate

**la clôture**  
fence

**le pré**  
pasture

**le bétail**  
livestock



**le tracteur** | tractor

**le cultivateur**  
cultivator



**la moissonneuse-batteuse** | combine



## les exploitations agricoles • types of farm

la culture  
crop



la ferme de culture  
crop farm



la ferme laitière  
dairy farm

le troupeau  
flock



la ferme d'élevage de  
moutons  
sheep farm



la ferme d'aviculture  
poultry farm



la ferme d'élevage  
porcin  
pig farm



le centre de  
pisciculture  
fish farm



l'exploitation fruitière  
fruit farm

la vigne  
vine

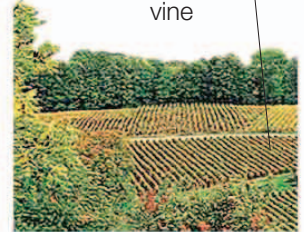

la vigne  
vineyard

## les activités • actions

le sillon  
furrow



labourer  
plow (v)



semer  
sow (v)



traire  
milk (v)

donner à manger  
feed (v)



arroser | water (v)



récolter | harvest (v)

### vocabulaire • vocabulary

l'herbicide  
herbicide

le troupeau  
herd

l'auge  
trough

le pesticide  
pesticide

le silo  
silo

planter  
plant (v)

# la ferme 2 • farm 2

## les cultures • crops



**le blé**  
wheat



**le maïs**  
corn



**l'orge**  
barley



**le colza**  
rapeseed



**le tournesol**  
sunflower



**la balle**  
bale

**le foin**  
hay



**la luzerne**  
alfalfa



**le tabac**  
tobacco



**le riz**  
rice



**le thé**  
tea



**le café**  
coffee



**l'épouvantail**  
scarecrow



**le lin**  
flax



**la canne à sucre**  
sugarcane



**le coton**  
cotton

# le bétail • livestock

le porcelet  
piglet



le cochon  
pig

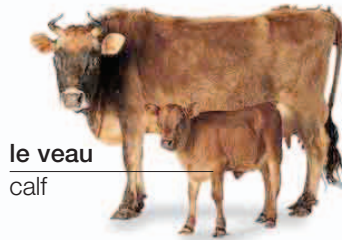

le veau  
calf

la vache  
cow



le taureau  
bull



le mouton  
sheep

le chevreau  
kid



l'agneau  
lamb

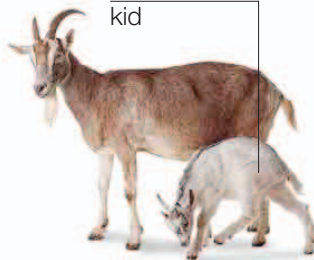

la chèvre  
goat



le poulain  
foal

le cheval  
horse



l'âne  
donkey

le poussin  
chick

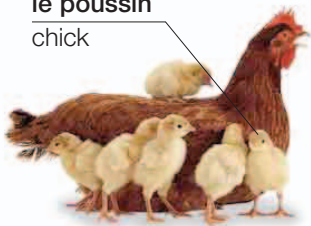

le poulet  
chicken



le coq  
rooster



le dindon  
turkey

le caneton  
duckling



le canard  
duck



l'écurie  
stable



l'enclos  
pen



le poulailler  
chicken coop



la porcherie  
pig sty

# la construction • construction

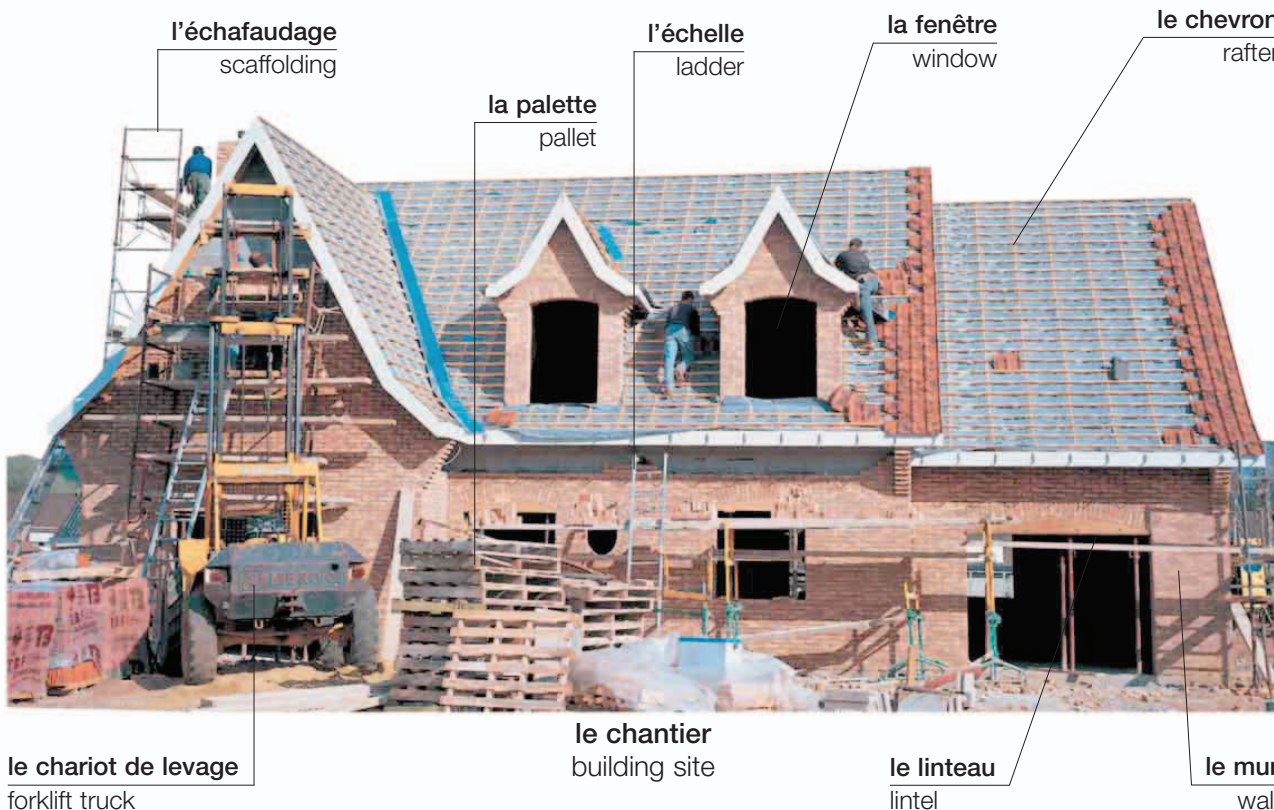

## les matériaux • materials



la brique  
brick



le bois  
lumber



la tuile  
roof tile



le bloc de béton  
concrete block

## les outils • tools

le mortier  
mortar

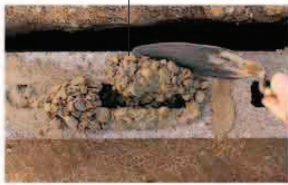

la truelle  
trowel



le niveau à bulle  
level



le marteau de  
forgeron  
sledgehammer

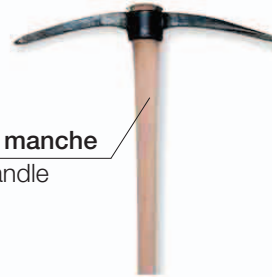

le manche  
handle

la pioche  
pickax



la pelle  
shovel

## les machines •

machinery



le rouleau compresseur  
roller



le tombereau  
dump truck



le  
crochet  
hook

la grue | crane

le support  
support

## les travaux • roadworks

le macadam  
goudronné  
asphalt



le marteau-  
piqueur  
jackhammer

le cône  
cone



le  
revêtement  
resurfacing

la pelle  
mécanique  
excavator

# les professions 1 • occupations 1



**le menuisier**  
carpenter



**l'électricien**  
electrician



**le plombier**  
plumber



**le maçon**  
construction worker



**le jardinier**  
gardener

**l'aspirateur**  
vacuum  
cleaner



**le nettoyeur**  
cleaner



**le mécanicien**  
mechanic



**le boucher**  
butcher



**le coiffeur**  
hairdresser



**la marchande de poissons**  
fish-seller



**le marchand de légumes**  
produce-seller



**la fleuriste**  
florist



**le coiffeur**  
barber



**le bijoutier**  
jeweler



**l'employée de magasin**  
sales clerk



**l'agent immobilier**  
realtor



**l'opticien**  
optician



**la dentiste**  
dentist

le masque  
mask



**le docteur**  
doctor



**la pharmacienne**  
pharmacist



**l'infirmière**  
nurse



**la vétérinaire**  
veterinarian



**le fermier**  
farmer



**le pêcheur**  
fisherman

la mitrailleuse  
machine gun



**le soldat**  
soldier



**le policier**  
police officer

le badge  
badge

l'uniforme  
uniform



**le garde**  
security guard



**le marin**  
sailor



**le pompier**  
firefighter

# les professions 2 • occupations 2



**l'avocat**  
lawyer



**le comptable**  
accountant



**l'architecte**  
architect



**la scientifique**  
scientist



**l'institutrice**  
teacher



**le bibliothécaire**  
librarian



**la réceptionniste**  
receptionist



**le facteur**  
mail carrier



**le conducteur de bus**  
bus driver



**le camionneur**  
truck driver



**le chauffeur de taxi**  
cab driver



**le pilote**  
pilot



**l'hôtesse de l'air**  
flight attendant



**l'agent de voyages**  
travel agent

**la toque**  
chef's hat



**le chef**  
chef





**le musicien**  
musician



**le tutu**  
tutu

**la danseuse**  
dancer



**la comédienne**  
actress



**la chanteuse**  
singer



**la serveuse**  
waitress



**le barman**  
bartender



**le sportif**  
sportsman



**le sculpteur**  
sculptor



**la peintre**  
painter



**le photographe**  
photographer



**la présentatrice**  
newscaster



**les notes**  
notes

**le journaliste**  
journalist



**la rédactrice**  
editor



**le dessinateur**  
designer



**la couturière**  
seamstress

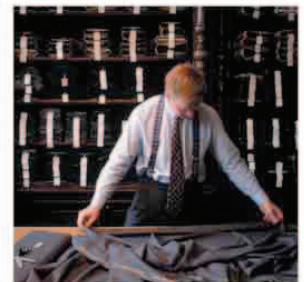

**le couturier**  
tailor





**le transport**  
transportation

[WWW.EBOOK777.COM](http://WWW.EBOOK777.COM)

# les routes • roads

**l'autoroute**  
freeway

**le poste de péage**  
toll booth

**les signalisations**  
road markings

**la bretelle d'accès**  
frontage road

**à sens unique**  
one-way

**l'îlot directionnel**  
divider

**le carrefour**  
interchange

**les feux**  
traffic light

**la file de droite**  
right lane

**la voie centrale**  
center lane

**la voie de dépassement**  
passing lane

**la bretelle de sortie**  
exit ramp

**la circulation**  
traffic

**l'autopont**  
overpass

**l'accotement stabilisé**  
shoulder

**le camion**  
truck

**le terre-plein**  
median strip

**le passage inférieur**  
underpass





le passage clouté  
crosswalk



le téléphone de secours  
emergency phone



le parking réservé aux personnes handicapées  
disabled parking



l'embouteillage  
traffic jam

le GPS  
satnav



le parc-mètre  
parking meter



l'agent de la circulation  
traffic policeman

**vocabulaire • vocabulary**

le rond-point  
roundabout

garer  
park (v)

remorquer  
tow away (v)

la déviation  
detour

doubler  
pass (v)

la route à quatre voies  
divided highway

les travaux  
road work

conduire  
drive (v)

C'est la route pour...?  
Is this the road to...?

la glissière de sécurité  
guard rail

faire marche arrière  
back up (v)

Où peut-on se garer?  
Where can I park?

**les panneaux routiers • road signs**



sens interdit  
do not enter



la limitation de vitesse  
speed limit



danger  
hazard



arrêt interdit  
no stopping



interdit de tourner à droite  
no right turn

# le bus • bus

le siège du  
conducteur  
driver's seat

la poignée  
handrail

la porte automatique  
automatic door

la roue avant  
front wheel

le compartiment à bagages  
luggage hold



la porte | door



le car | long-distance bus

## les types de bus • types of buses

le numéro de bus  
route number

le conducteur  
driver



le bus à deux étages  
double-decker bus



le tramway  
tram



le trolleybus  
trolley bus



le bus scolaire | school bus

la roue arrière  
rear wheel

la fenêtre  
window

le bouton d'arrêt  
stop button



le ticket  
bus ticket



la sonnette  
bell



la gare routière  
bus station



l'arrêt de bus  
bus stop

**vocabulaire • vocabulary**

le prix du ticket  
fare

l'accès aux handicapés  
wheelchair access

l'horaire  
schedule

l'abribus  
bus stop shelter

Vous stoppez à...?  
Do you stop at...?

C'est quel bus pour  
aller à...?  
Which bus goes to...?



le minibus  
minibus



le bus de touristes | tour bus



la navette | shuttle bus

# la voiture 1 • car 1

## l'extérieur • exterior

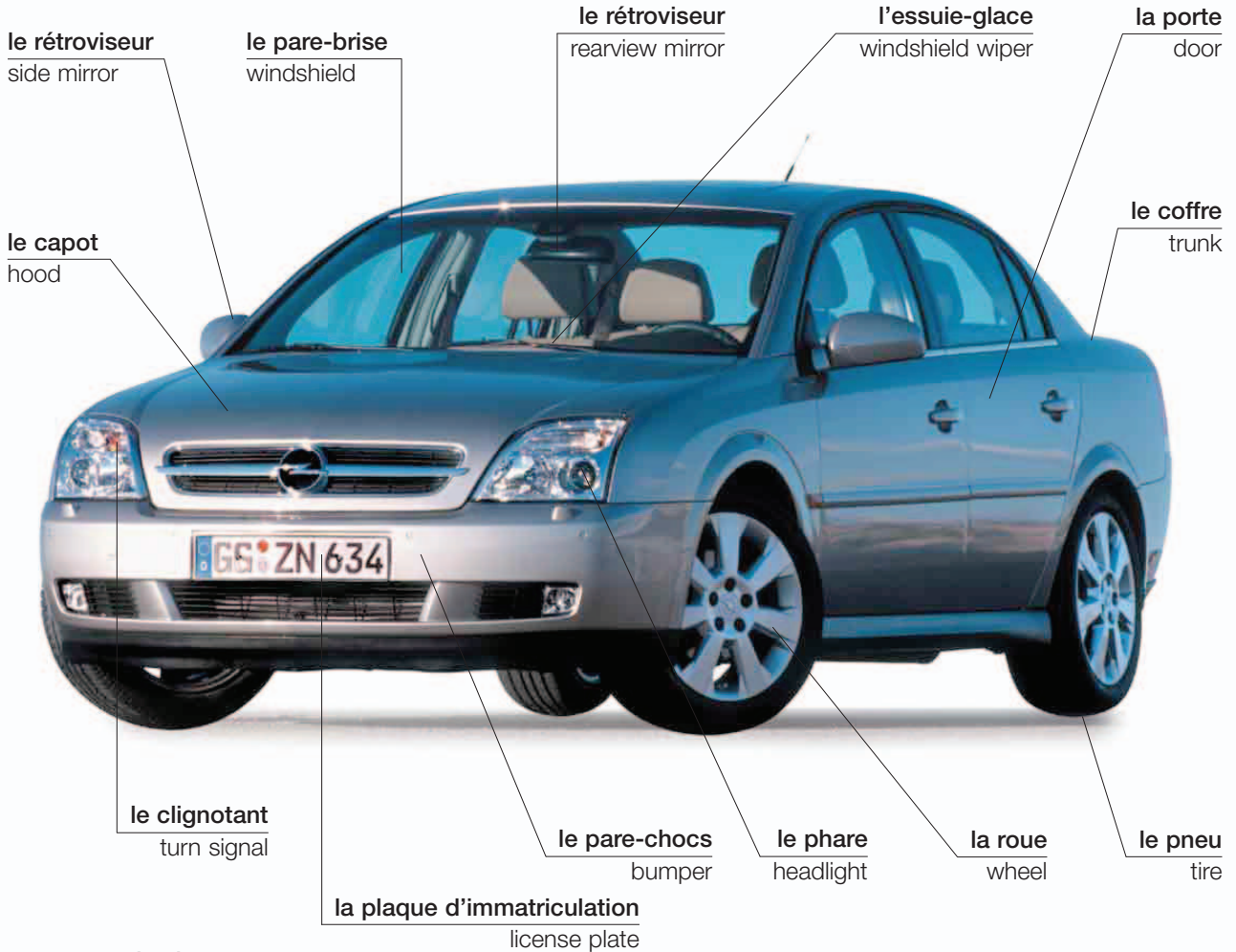



les modèles • types



la voiture électrique  
electric car



la berline à hayon  
hatchback



la berline  
sedan



le break  
station wagon



la décapotable  
convertible



le cabriolet sport  
sports car



la voiture à six places  
minivan



la quatre-quatre  
four-wheel drive

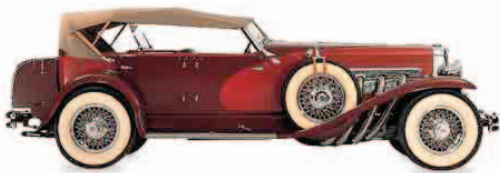

la voiture d'époque  
vintage



la limousine  
limousine

la station-service • gas station

la pompe  
gas pump

le tarif  
price



l'aire de stationnement  
forecourt

vocabulaire • vocabulary

l'huile oil      avec plomb leaded      le lave-auto car wash

l'essence gasoline      le diesel diesel      l'antigel antifreeze

sans plomb unleaded      le garage garage      le lave-glace washer fluid

Le plein, s'il vous plaît.  
Fill it up, please.

# la voiture 2 • car 2

## l'intérieur • interior

le siège arrière  
back seat

l'accoudoir  
armrest

le repose-tête  
headrest

le verrouillage  
door lock

la poignée  
handle



### vocabulaire • vocabulary

à deux portes  
two-door

à quatre portes  
four-door

automatique  
automatic

le frein  
brake

l'accélérateur  
accelerator

à trois portes  
hatchback

manuel  
manual

l'allumage  
ignition

l'embrayage  
clutch

la climatisation  
air conditioning

Pouvez-vous m'indiquer la route pour...?  
Can you tell me the way to...?

Où est le parking?  
Where is the parking lot?

On peut se garer ici?  
Can I park here?

## les commandes • controls

**le volant**  
steering  
wheel

**le klaxon**  
horn

**le tableau de bord**  
dashboard

**les feux de détresse**  
hazard lights

**le navigateur par satellite**  
satellite navigation



la conduite à gauche | left-hand drive

**le thermomètre**  
temperature gauge

**le compte-tours**  
tachometer

**le compteur**  
speedometer

**la jauge d'essence**  
fuel gauge

**la stéréo**  
car stereo

**l'interrupteur feux**  
light switch

**la manette de chauffage**  
heater controls

**l'odomètre**  
odometer

**le levier de vitesses**  
gearshift

**l'airbag**  
air bag



la conduite à droite | right-hand drive

# la voiture 3 • car 3

## la mécanique • mechanics

le réservoir de  
lave-glace  
washer fluid reservoir

la jauge d'huile  
dipstick

le filtre à air  
air filter

le réservoir de liquide de frein  
brake fluid reservoir

la batterie  
battery



la  
carrosserie  
bodywork

le réservoir de liquide de  
refroidissement  
coolant reservoir

la culasse  
cylinder head

le tuyau  
pipe

le toit ouvrant  
sunroof

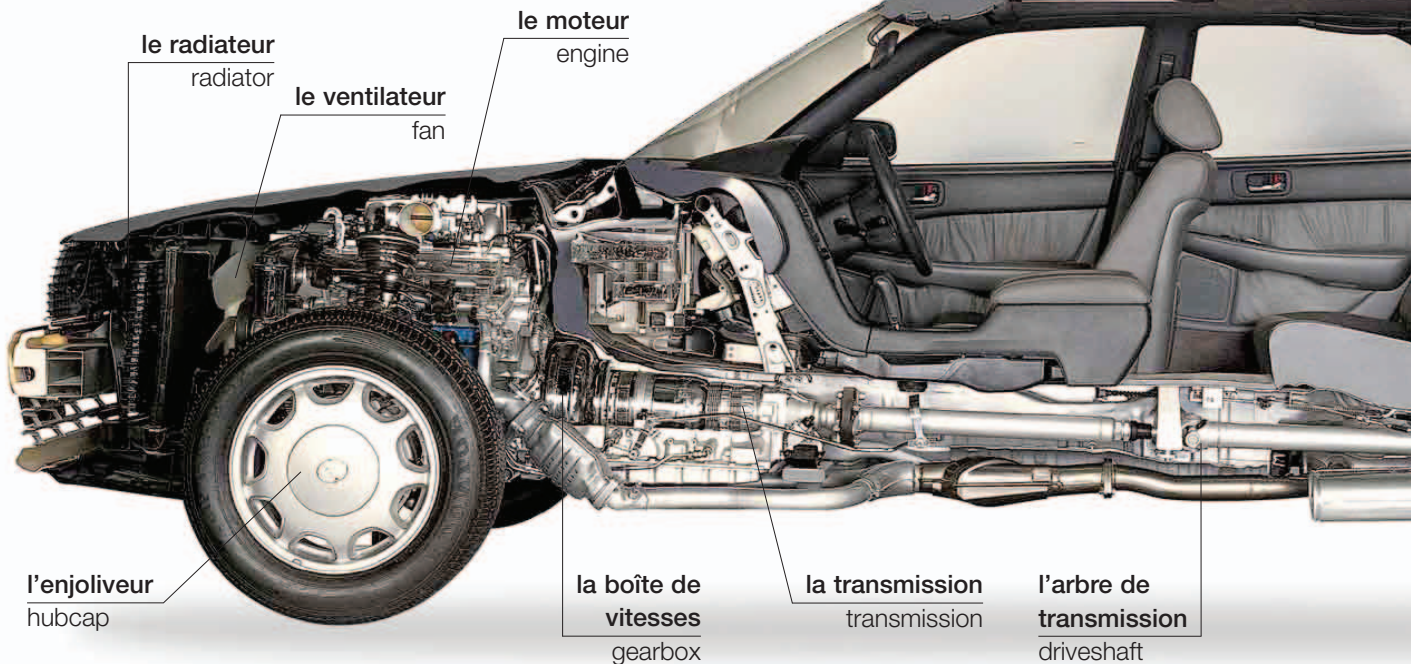

le radiateur  
radiator

le ventilateur  
fan

le moteur  
engine

l'enjoliveur  
hubcap

la boîte de  
vitesses  
gearbox

la transmission  
transmission

l'arbre de  
transmission  
driveshaft

la crevaison • flat tire

la roue de secours  
spare tire

la manivelle  
tire iron

les écrous de roue  
wheel nuts

le cric  
jack

changer une roue  
change a tire (v)

le toit  
roof

la suspension  
suspension

le silencieux  
muffler

le pot d'échappement  
exhaust pipe

vocabulaire • vocabulary

l'accident de voiture  
car accident

le turbocompresseur  
turbocharger

la panne  
breakdown

le distributeur  
distributor

l'assurance  
insurance

le châssis  
chassis

la dépanneuse  
towtruck

le frein à main  
parking brake

le mécanicien  
mechanic

l'alternateur  
alternator

la pression des  
pneus  
tire pressure

la courroie de  
cames  
cam belt

le porte-fusibles  
fuse box

Ma voiture est en  
panne.  
My car has broken  
down.

la bougie  
sparkplug

la courroie de  
ventilateur  
fan belt

Ma voiture ne  
démarche pas.  
My car won't start.

le réservoir  
d'essence  
gas tank

Faites-vous les  
réparations?  
Do you do repairs?

le réglage de  
l'allumage  
timing

Le moteur chauffe  
The engine is  
overheating

# la moto • motorcycle

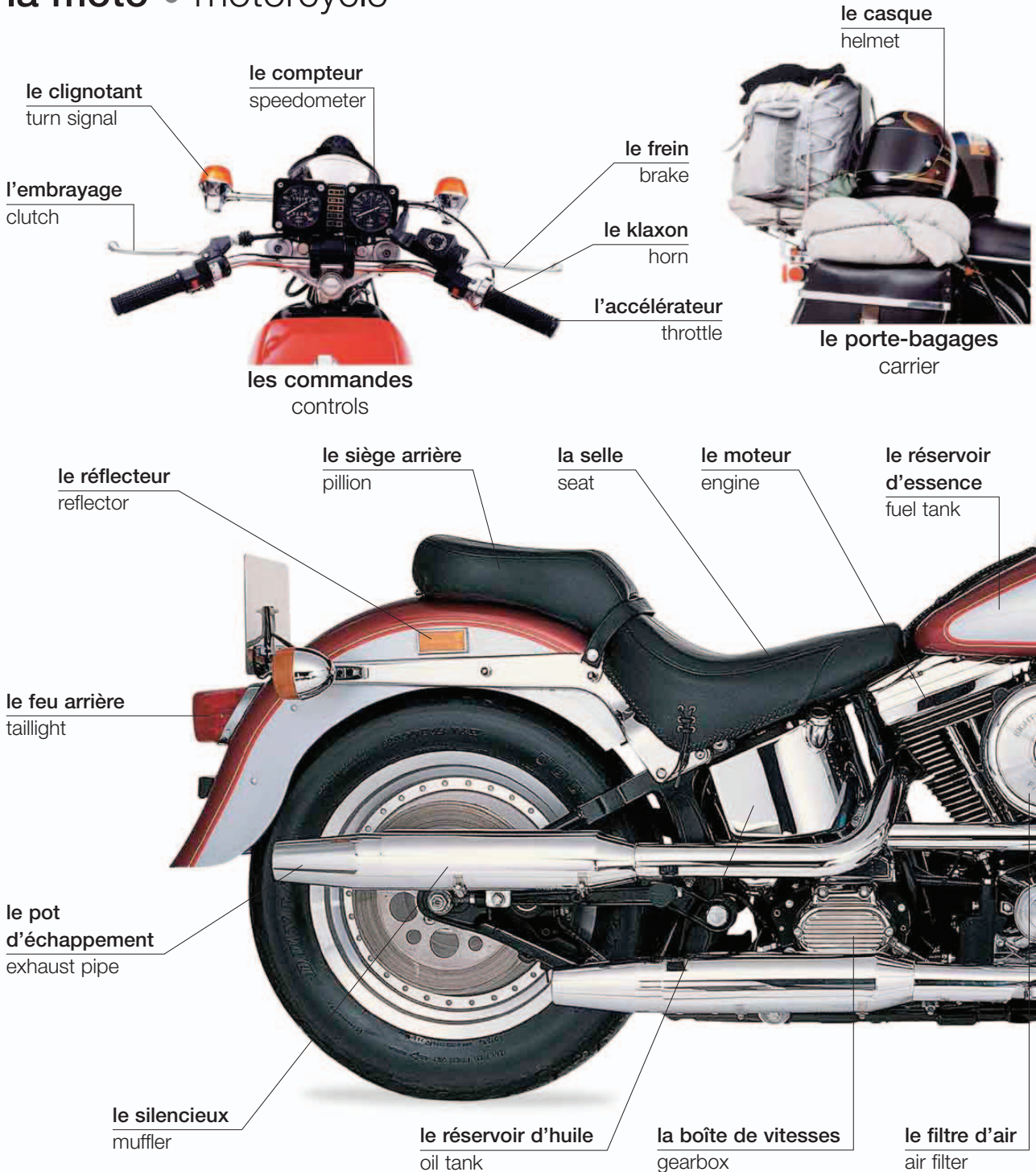



la visière  
visor

le vêtement en cuir  
leathers

la bande  
fluorescente  
reflector strap

la genouillère  
knee pad

les vêtements | clothing

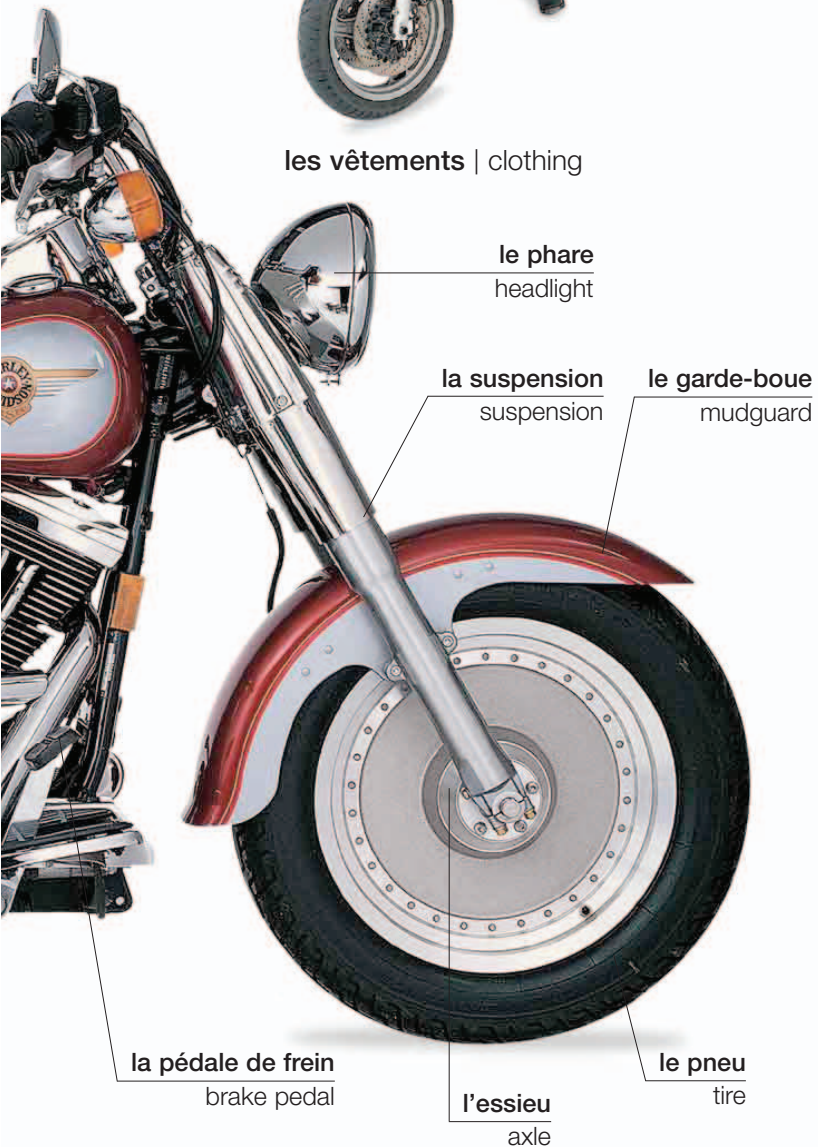

le phare  
headlight

la suspension  
suspension

le garde-boue  
mudguard

la pédale de frein  
brake pedal

l'essieu  
axle

le pneu  
tire

## les types • types



la moto de course | racing bike

le pare-brise  
windshield



la moto routière | tourer



la moto tout-terrain | dirt bike

la béquille  
stand



le scooter | scooter

# la bicyclette • bicycle



**le tandem**  
tandem



**le vélo de course**  
racing bike



**le vélo tout-terrain**  
mountain bike



**le vélo de randonnée**  
touring bike



**le vélo de ville**  
road bike

**la selle**  
saddle

**le tube porte-selle**  
seat post

**la bouteille d'eau**  
water bottle

**le cadre**  
frame

**le frein**  
brake

**le moyeu**  
hub

**les vitesses**  
gears

**la jante**  
rim

**le pneu**  
tire

**la chaîne**  
chain

**la pédale**  
pedal

**la roue dentée**  
cog



**la piste cyclable | bike lane**





**vocabulaire • vocabulary**

<b>le phare</b> headlight	<b>la béquille</b> kickstand	<b>le patin de frein</b> brake block	<b>le panier</b> basket	<b>le cale-pied</b> toe clip	<b>freiner</b> brake (v)
<b>le feu arrière</b> rear light	<b>la galerie à vélo</b> bike rack	<b>le câble</b> cable	<b>la dynamo</b> dynamo	<b>la lanière</b> toe strap	<b>faire du vélo</b> cycle (v)
<b>le catapote</b> reflector	<b>les roues d'entraînement</b> training wheels	<b>le pignon</b> sprocket	<b>la crevaison</b> flat tire	<b>pédaler</b> pedal (v)	<b>changer de vitesse</b> change gears (v)

# le train • train

la voiture  
car

le quai  
platform

le caddie  
cart



le numéro de  
voie  
platform number

le voyageur  
commuter

la gare | train station

## les types de trains • types of train



le train à vapeur  
steam train

la locomotive  
engine



le train diesel | diesel train

la cabine du  
conducteur  
engineer's  
cab

le rail  
rail



le train électrique  
electric train



le train à grande vitesse  
high-speed train



le monorail  
monorail



le métro  
subway



le tram  
tram



le train de marchandises  
freight train



**le compartiment**  
compartment

**le porte-bagages**  
luggage rack

**la fenêtre**  
window

**la voie ferrée**  
track

**la porte**  
door

**le siège**  
seat



**le portillon**  
ticket gate

**le haut-parleur**  
public address system

**l'horaire**  
schedule



**le billet**  
ticket



**la voiture-restaurant** | dining car



**le hall de gare** | concourse



**le compartiment-couchettes**  
sleeping compartment

**vocabulaire** • vocabulary

**le réseau ferroviaire**  
rail network

**le plan de métro**  
subway map

**le guichet**  
ticket office

**le rail conducteur**  
live rail

**le rapide**  
express train

**le retard**  
delay

**le contrôleur**  
ticket inspector

**le signal**  
signal

**l'heure de pointe**  
rush hour

**le prix**  
fare

**changer**  
change trains (v)

**la manette de secours**  
emergency lever

# l'avion • aircraft

## l'avion de ligne • airliner



## la cabine • cabin





**la montgolfière**  
hot-air balloon



**l'U.L.M.**  
ultralight



**le planeur**  
glider



**le biplan**  
biplane

**l'hélice**  
propeller



**l'avion léger**  
light aircraft



**l'hydravion**  
sea plane



**le jet privé**  
private jet

**le missile**  
missile



**le chasseur**  
fighter plane

**la pale de rotor**  
rotor blade



**l'hélicoptère**  
helicopter



**le bombardier**  
bomber

**vocabulaire** • vocabulary

**le pilote**  
pilot

**décoller**  
take off (v)

**atterrir**  
land (v)

**la classe économique**  
economy class

**les bagages à main**  
carry-on luggage

**le copilote**  
co-pilot

**voler**  
fly (v)

**l'altitude**  
altitude

**la classe affaires**  
business class

**la ceinture de sécurité**  
seat belt

# l'aéroport • airport



**l'aire de stationnement**  
apron

**le porte-bagages**  
baggage trailer

**le terminal**  
terminal

**le véhicule de service**  
service vehicle

**la passerelle**  
walkway

**l'avion de ligne** | airliner

## vocabulaire • vocabulary

**la piste**  
runway

**le numéro de vol**  
flight number

**le tapis roulant**  
carousel

**les vacances**  
vacation

**le vol international**  
international flight

**l'immigration**  
immigration

**la sécurité**  
security

**enregistrer**  
check in (v)

**le vol domestique**  
domestic flight

**la douane**  
customs

**la machine de rayons x**  
X-ray machine

**la tour de contrôle**  
control tower

**la correspondance**  
connection

**l'excédent de bagages**  
excess baggage

**la brochure de vacances**  
travel brochure

**faire une réservation de vol**  
make a flight reservation (v)

les bagages à main  
carry-on  
luggage

les bagages  
luggage

le chariot  
cart



l'enregistrement des bagages  
check-in desk



le passeport | passport

le visa  
visa



le contrôle de  
passeports  
passport control

la carte  
d'embarquement  
boarding pass



le billet  
ticket



la salle de départ  
departure lounge

le numéro de la  
porte  
d'embarquement  
gate number

les départs  
departures



l'écran d'information  
information screen

la destination  
destination

les arrivées  
arrivals



la boutique hors  
taxes  
duty-free shop



le retrait des bagages  
baggage claim



la station de taxis  
taxi stand



la location de  
voitures  
car rental

# le navire • ship

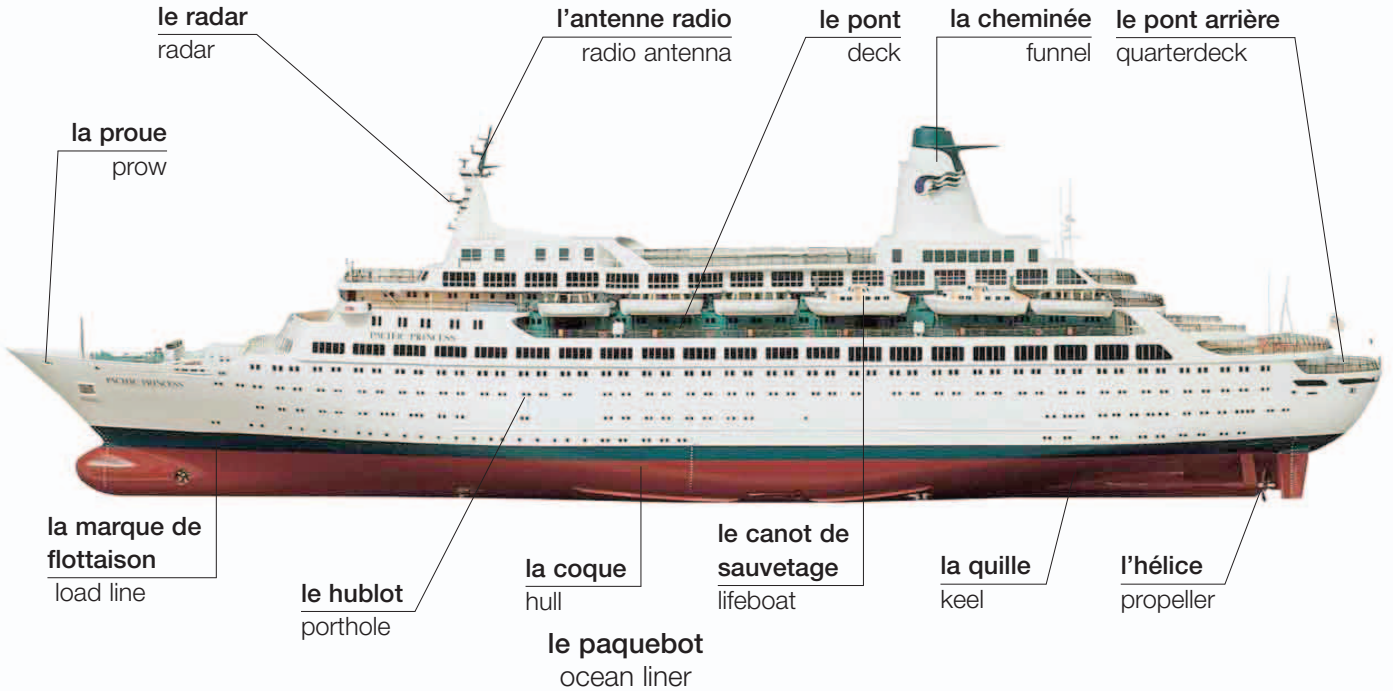

la passerelle de commandement  
bridge



la salle des moteurs  
engine room



la cabine  
cabin



la cuisine  
galley

## vocabulaire • vocabulary

le dock  
dock

le port  
port

la passerelle  
gangway

l'ancre  
anchor

le bollard  
bollard

le guindeau  
windlass

le capitaine  
captain

le runabout  
speedboat

la barque  
rowboat

le canoë  
canoe



autres bateaux • other ships



le ferry  
ferry

le hors-bord  
outboard motor



le canot pneumatique  
inflatable dinghy



l'hydroptère  
hydrofoil



le yacht  
yacht



le catamaran  
catamaran



le remorqueur  
tugboat



l'aéroglysieur  
hovercraft



le navire porte-conteneurs  
container ship

le gréement  
rigging



le voilier  
sailboat

la cale  
hold



le cargo  
freighter



le pétrolier  
oil tanker



le porte-avions  
aircraft carrier



le navire de guerre  
battleship

le kiosque  
conning tower



le sous-marin  
submarine

# le port • port

**l'entrepôt**  
warehouse

**la grue**  
crane

**le chariot élévateur**  
forklift truck

**la route d'accès**  
access road

**le bureau des douanes**  
customs house



**le dock**  
dock

**le conteneur**  
container

**le quai**  
quay

**la cargaison**  
cargo



le port de conteneurs | container port

**le terminal de ferrys**  
ferry terminal

**le ferry**  
ferry

**le guichet**  
ticket office

**le passager**  
passenger

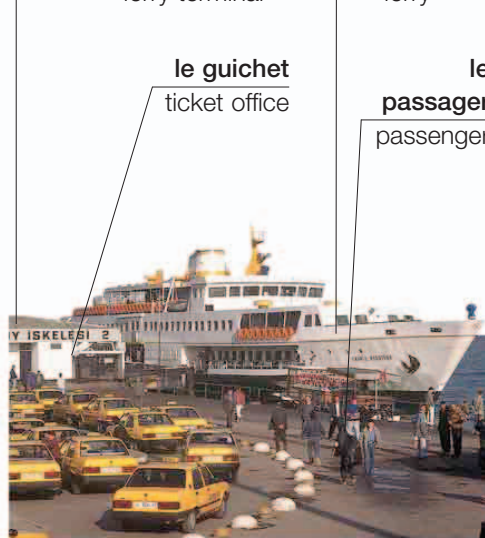

le port de passagers | passenger port

le filet  
net

le bateau de pêche  
fishing boat

les amarres  
mooring



la marina  
marina



le port de pêche  
fishing port

le port  
harbor



l'embarcadère  
pier



la jetée  
jetty



le chantier naval  
shipyard



le feu  
lamp

le phare  
lighthouse



la bouée  
buoy

**vocabulaire • vocabulary**

le garde-côte  
coastguard

la cale sèche  
dry dock

embarquer  
board (v)

le capitaine de port  
harbor master

mouiller  
moor (v)

débarquer  
disembark (v)

jeter l'ancre  
drop anchor (v)

se mettre à quai  
dock (v)

prendre la mer  
set sail (v)





les sports  
sports

# le football américain • football

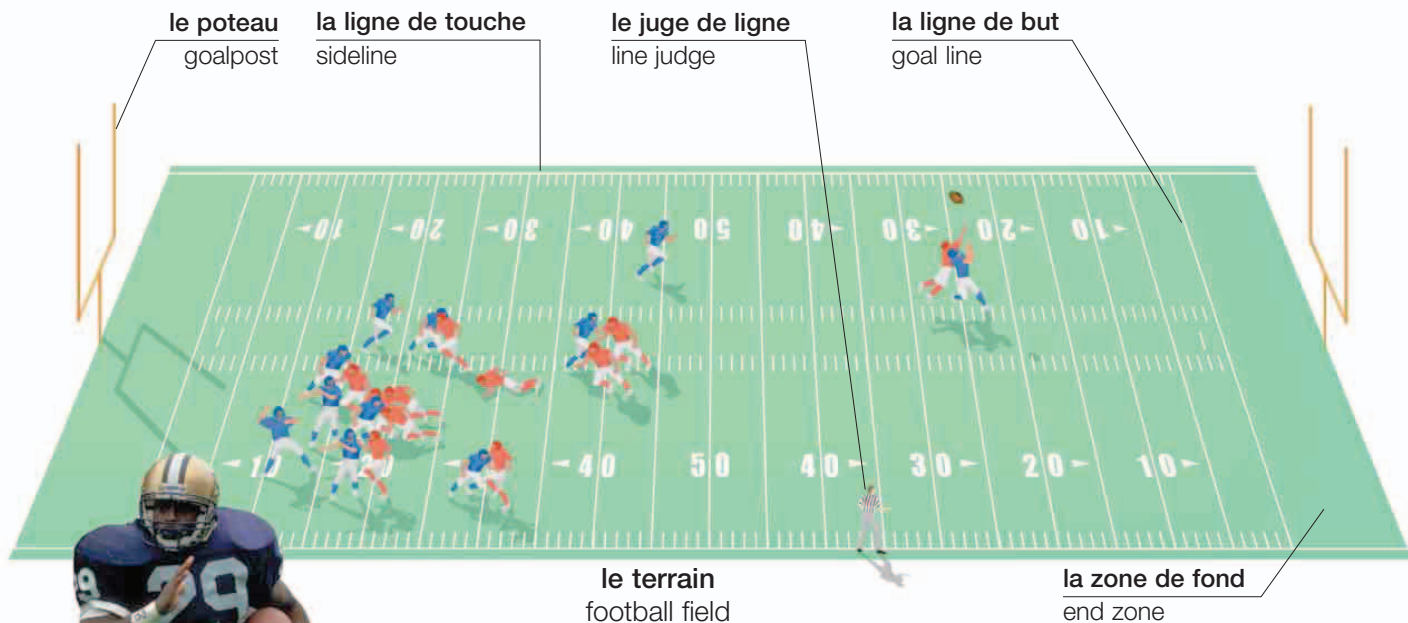

le joueur de football  
football player

le ballon  
football

les protections  
pads

le casque  
helmet

la chaussure  
shoe



tacler  
tackle (v)



faire une passe  
pass (v)



attraper  
catch (v)

## vocabulaire • vocabulary

le temps mort  
time out

l'équipe  
team

la défense  
defense

la majorette  
cheerleader

Où en est le match?  
What is the score?

la prise de ballon maladroite  
fumble

l'attaque  
attack

le score  
score

le but  
touchdown

Qui est-ce qui gagne?  
Who is winning?

# le rugby • rugby

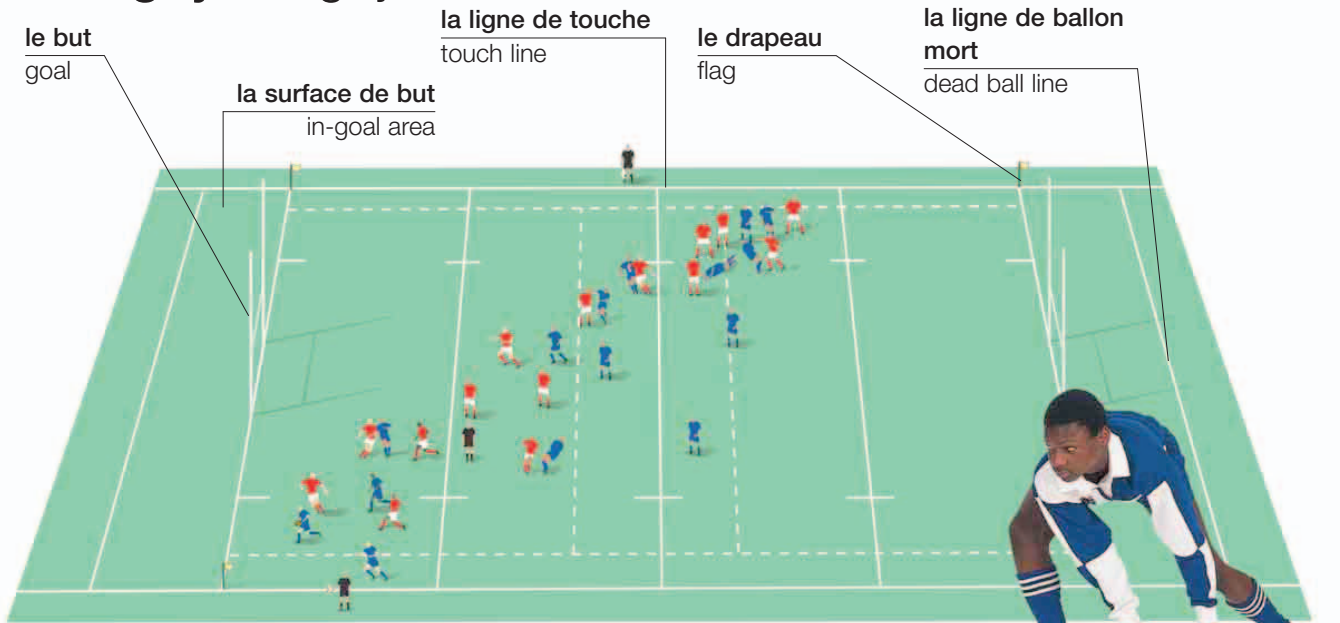

le terrain de rugby | rugby field



lancer  
throw (v)

le ballon  
ball



botter  
kick (v)

le maillot de  
rugby  
rugby uniform



faire une passe  
pass (v)



tacler  
tackle (v)



l'essai  
try



la mêlée ouverte | ruck

le joueur  
player



la mêlée | scrum

# le football • soccer



le ballon  
football

le gardien de but  
goalkeeper

la tenue  
soccer  
uniform

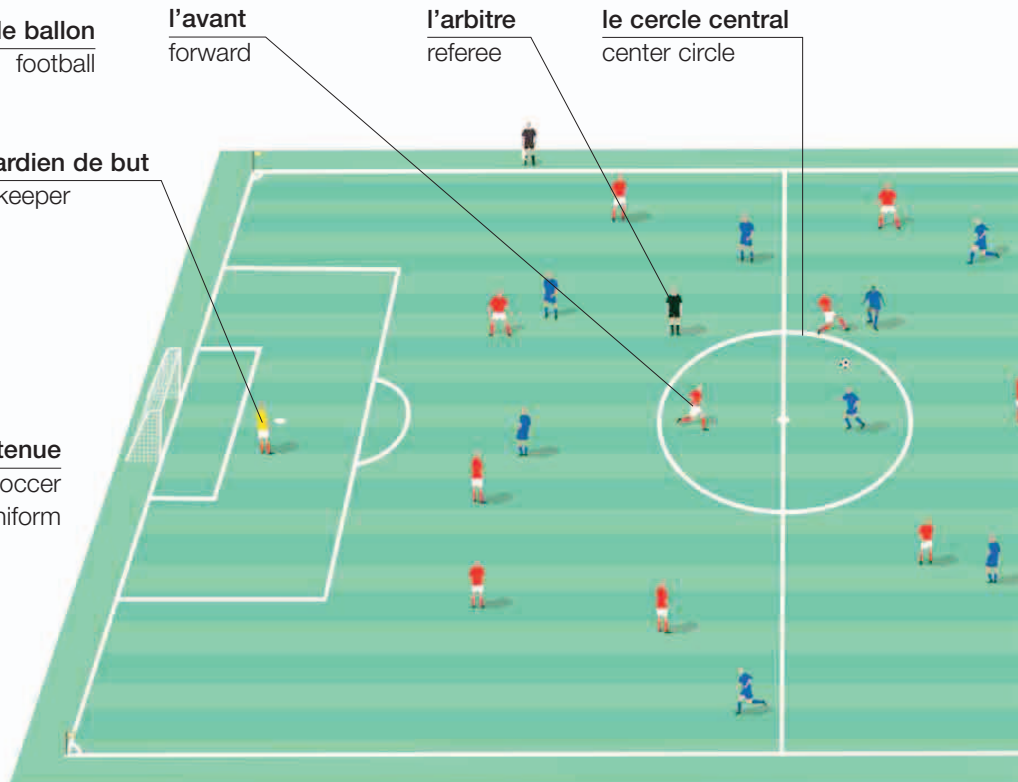

l'avant  
forward

l'arbitre  
referee

le cercle central  
center circle

le joueur de foot  
soccer player

le poteau  
goalpost

le filet  
net

la barre  
transversale  
crossbar



le but | goal

le terrain  
football field



dribbler | dribble (v)



faire une tête  
head (v)



le coup franc | free kick

le mur  
wall



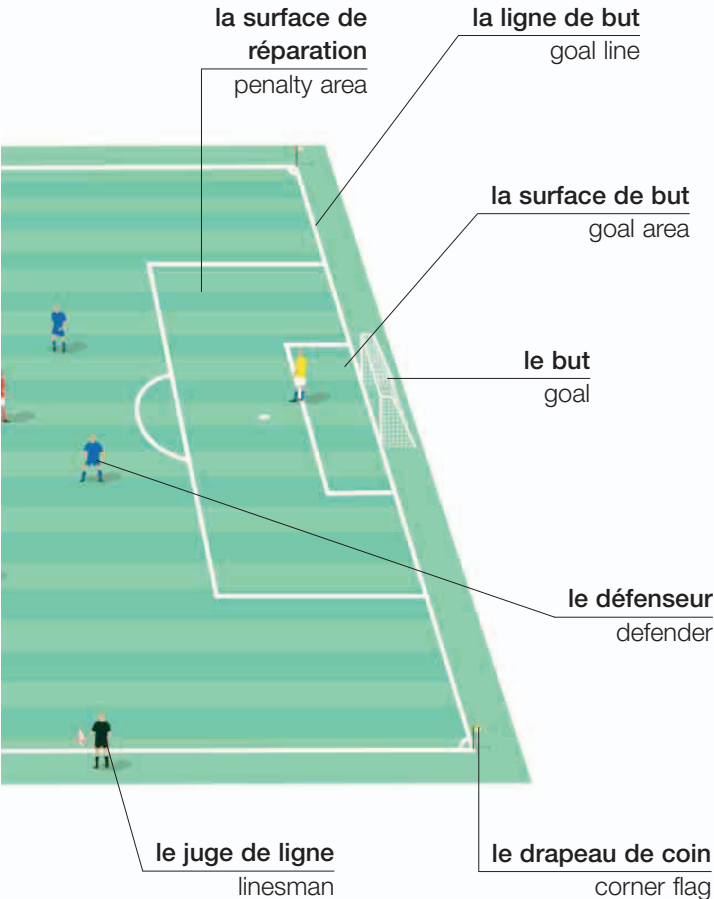

la rentrée en touche  
throw-in



botter  
kick (v)



faire une passe  
pass (v)

la chaussure  
shoe



shooter  
shoot (v)



sauver  
save (v)

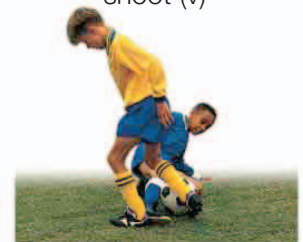

tacler  
tackle (v)

**vocabulaire** • vocabulary

**le stade**  
stadium

**la faute**  
foul

**le carton jaune**  
yellow card

**le championnat**  
league

**la prolongation**  
extra time

**marquer un but**  
score a goal (v)

**le corner**  
corner

**l'hors-jeu**  
off-side

**l'égalité**  
draw

**le remplaçant**  
substitute

**le penalty**  
penalty

**le carton rouge**  
red card

**l'expulsion**  
send off

**la mi-temps**  
half time

**le remplacement**  
substitution

# le hockey • hockey

## le hockey sur glace • ice hockey



## le hockey • field hockey

la crosse de hockey  
hockey stick

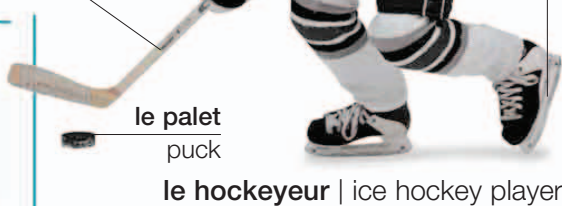

# le cricket • cricket

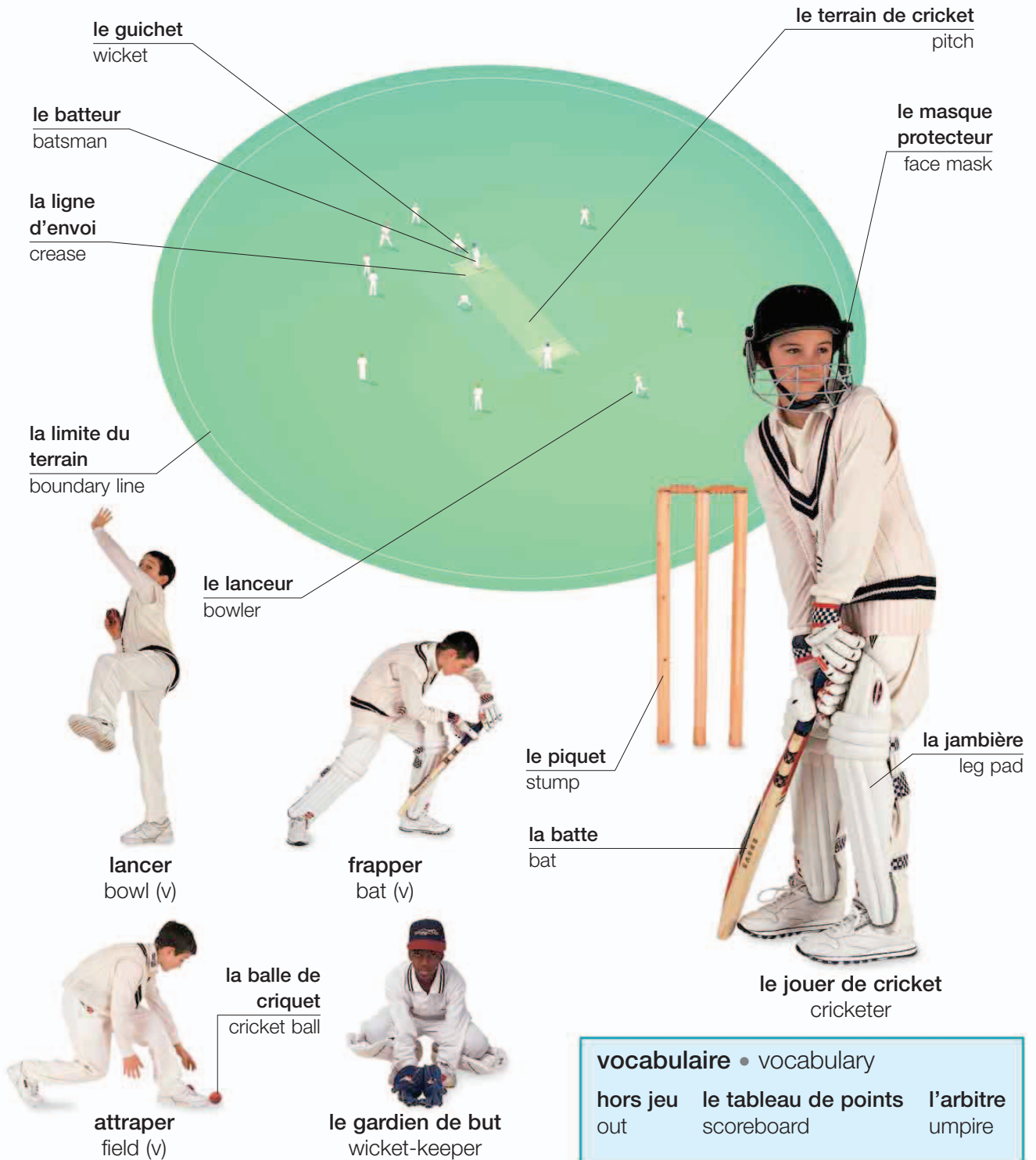

vocabulaire • vocabulary		
hors jeu out	le tableau de points scoreboard	l'arbitre umpire

# le basket • basketball

la ligne de touche  
sideline

l'arbitre  
referee

le cercle central  
center circle

la ligne de lancer franc  
free-throw line

la ligne de bout  
endline



le terrain  
court

la ligne de centre  
centerline

la ligne de trois points  
three-point line

le numéro  
number

le panneau  
backboard

l'anneau  
hoop

le filet  
net

le panier  
basket



le ballon  
ball

le joueur de basket | basketball player

## vocabulaire • vocabulary

la passe  
pass

la rentrée  
throw-in

la faute  
foul

l'entre-deux  
jump ball

le rebond  
rebound

hors jeu  
out of bounds

les actions • actions



**lancer**  
throw (v)



**attraper**  
catch (v)



**tirer**  
shoot (v)



**sauter**  
jump (v)



**faire un dunk**  
dunk (v)



**marquer**  
mark (v)



**bloquer**  
block (v)



**faire rebondir**  
dribble (v)



le volley • volleyball

**bloquer**  
block (v)

**le filet**  
net

**faire une manchette**  
dig (v)

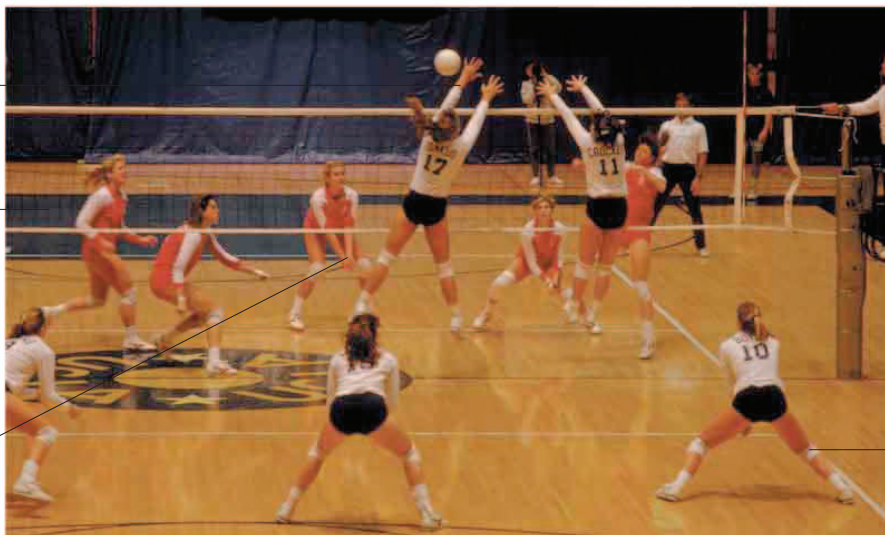

**l'arbitre**  
referee

**la genouillère**  
knee support

**le terrain** | court

# le baseball • baseball

## le terrain • field

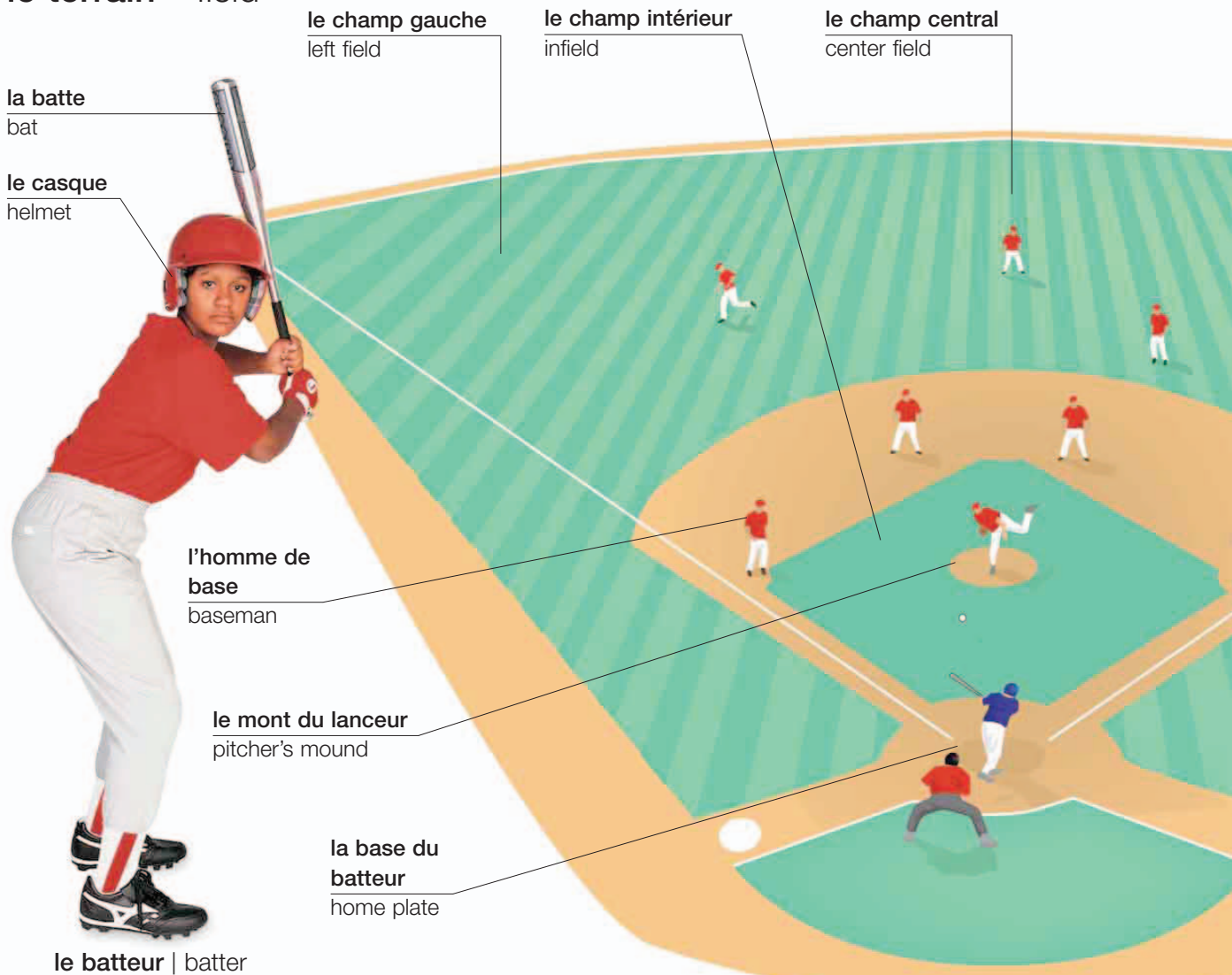

le batteur | batter

### vocabulaire • vocabulary

<b>le tour de batte</b> inning	<b>sauf</b> safe	<b>la fausse balle</b> foul ball
<b>le point</b> run	<b>hors jeu</b> out	<b>le coup manqué</b> strike



le gant  
mitt

la balle  
ball



le masque  
mask

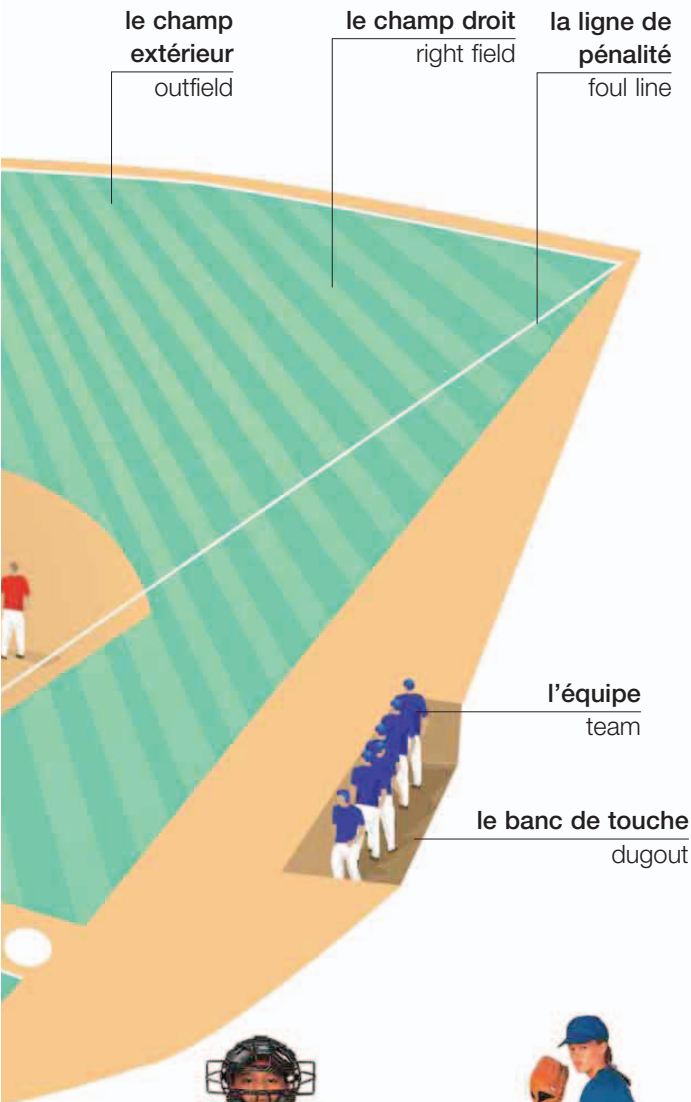

le receveur  
catcher



le lanceur  
pitcher

les actions • actions



lancer | throw (v)



attraper | catch (v)



courir  
run (v)



être en défense  
field (v)

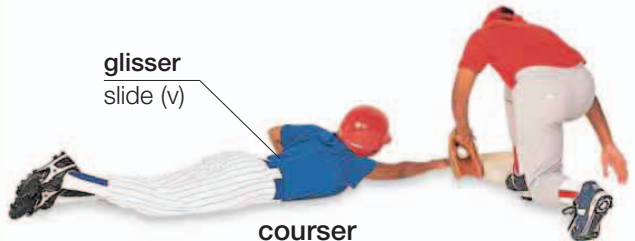

glisser  
slide (v)

courser  
tag (v)

lancer  
pitch (v)

batter  
bat (v)

l'arbitre  
umpire

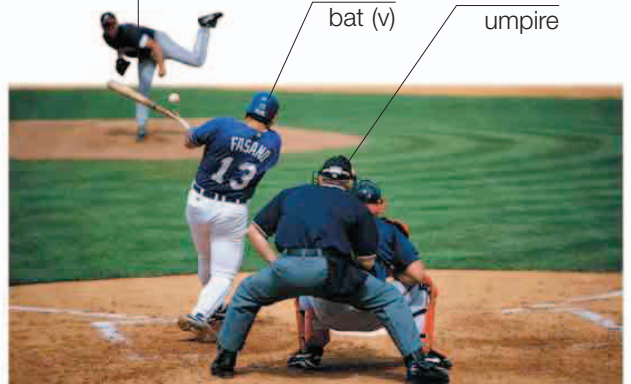

jouer | play (v)

# le tennis • tennis

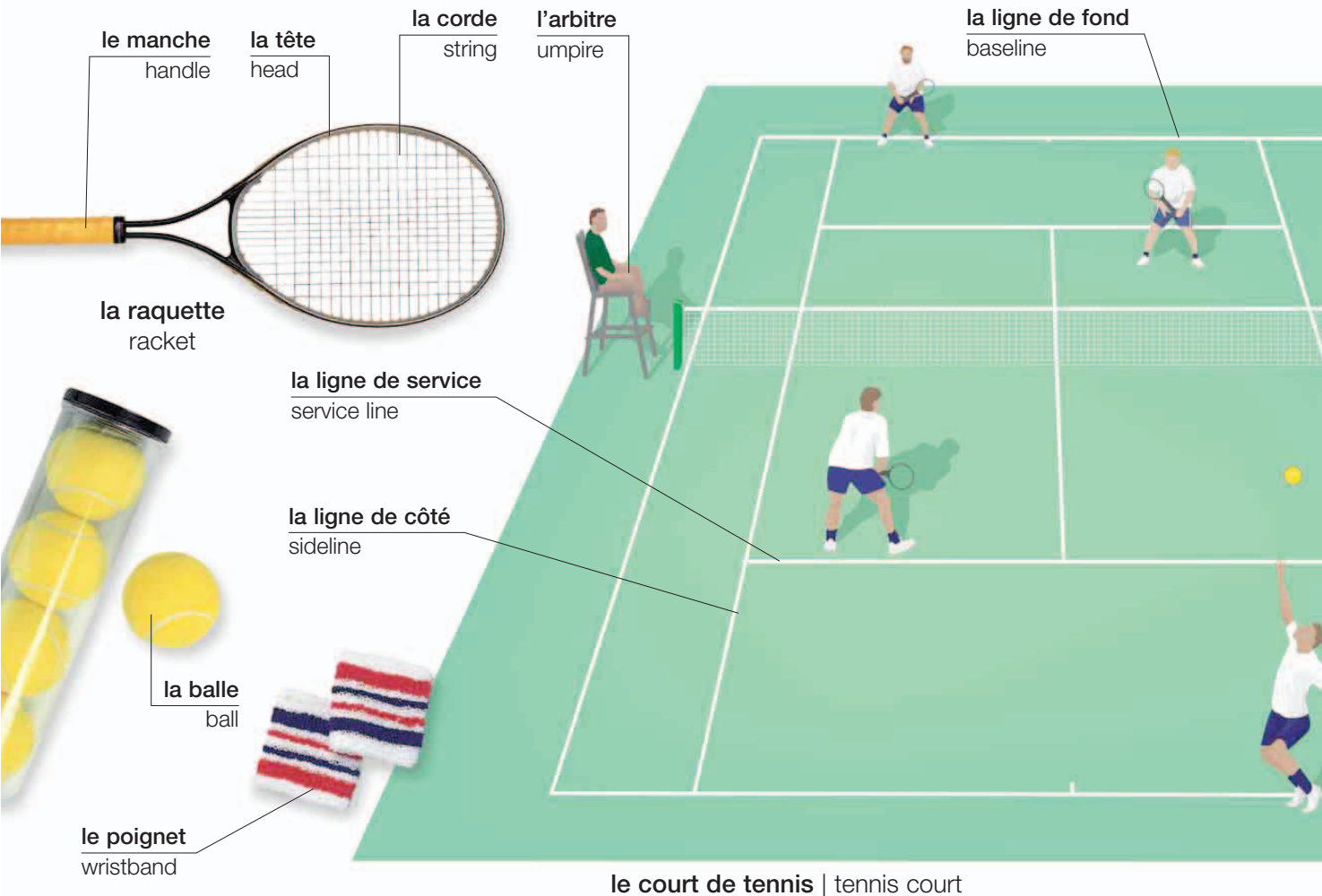

## vocabulaire • vocabulary

**le simple**  
singles

**le set**  
set

**l'égalité**  
deuce

**la faute**  
fault

**le slice**  
slice

**l'effet**  
spin

**le double**  
doubles

**le match**  
match

**l'avantage**  
advantage

**l'as**  
ace

**l'échange**  
rally

**le juge de ligne**  
linesman

**le jeu**  
game

**le tiebreak**  
tiebreaker

**zéro**  
love

**l'amorti**  
dropshot

**net!**  
let!

**le championnat**  
championship



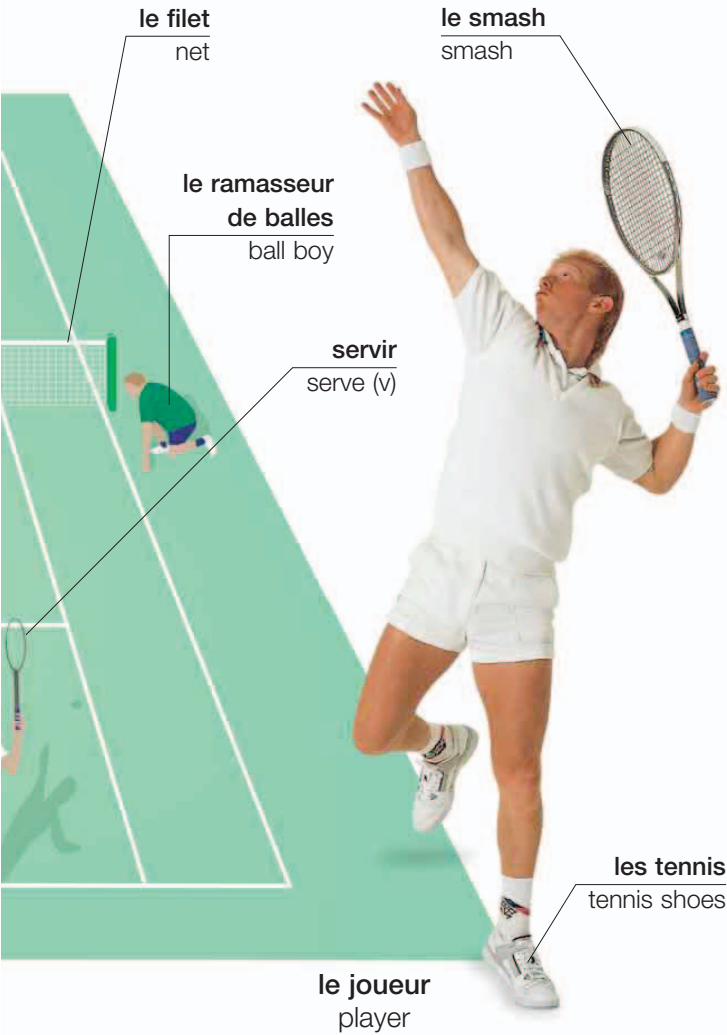

les coups • strokes



le service  
serve



la volée  
volley



le retour  
return



le lob  
lob



le coup droit  
forehand



le revers  
backhand

les jeux de raquette • racquet games



le badminton  
badminton

le volant  
shuttlecock



le tennis de table  
table tennis

la raquette  
paddle



le squash  
squash



le racquetball  
racquetball

# le golf • golf



le trou  
hole

le départ  
teeing ground

le green  
green

le bunker  
bunker

le drapeau  
flag

exécuter un swing  
swing (v)

le fairway  
fairway

le rough  
rough

l'obstacle d'eau  
water hazard

le parcours de golf  
golf course

le buggy  
golf cart

la position  
stance



la joueuse de golf | golfer



le pavillon | clubhouse

**l'équipement • equipment**



**les clubs de golf • golf clubs**



le bois  
wood



le putter  
putter



le fer  
iron



la cale  
wedge

**les actions • actions**



partir du tee  
tee-off (v)



driver  
drive (v)



putter  
putt (v)



cocher  
chip (v)

**vocabulaire • vocabulary**

le par  
par

le over par  
over par

le handicap  
handicap

le caddie  
caddy

le swing en arrière  
backswing

le coup  
stroke

le under par  
under par

le trou en un  
hole in one

le tournoi  
tournament

les spectateurs  
spectators

le swing d'essai  
practice swing

la ligne de jeu  
line of play

# l'athlétisme • track and field

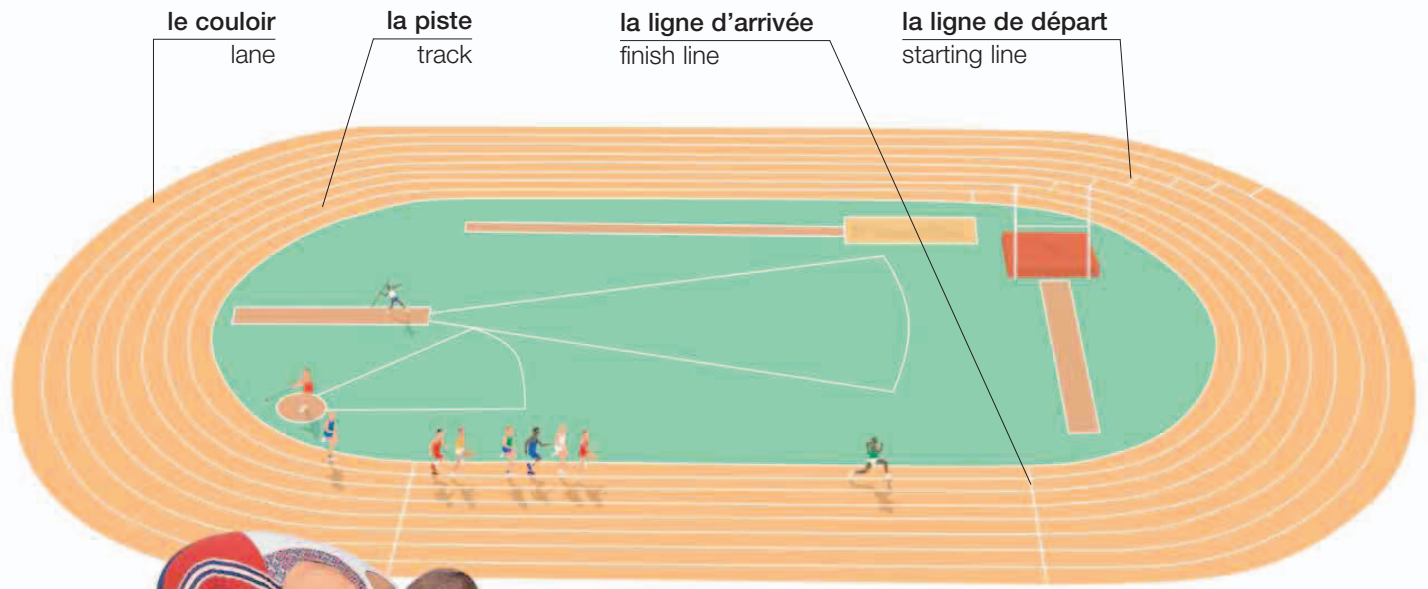

le bloc de départ  
starting blocks

le sprinter  
sprinter



le disque  
discus

le terrain  
field

l'athlète  
athlete



le lancement du poids  
shotput



le javelot  
javelin

## vocabulaire • vocabulary

la course  
race

le record  
record

le photo-finish  
photo finish

le saut à la perche  
pole vault

le temps  
time

battre un record  
break a record (v)

le marathon  
marathon

le record personnel  
personal best



le chronomètre  
stopwatch

**le bâton**

baton



**le relais**  
relay race

**la barre**

crossbar



**le saut en hauteur**  
high jump



**le saut en longueur**  
long jump



**les haies**  
hurdles

**la gymnastique • gymnastics**



**le cheval**  
horse

**le saut**  
vault

**le tremplin**  
springboard



**le salto**  
somersault

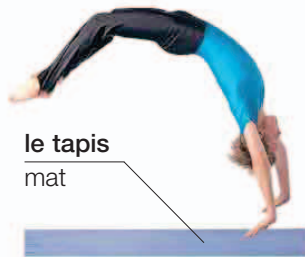

**le tapis**  
mat

**les exercices au sol**  
floor exercises

**la gymnaste**  
gymnast



**la poutre**  
beam

**le drapeau**  
ribbon

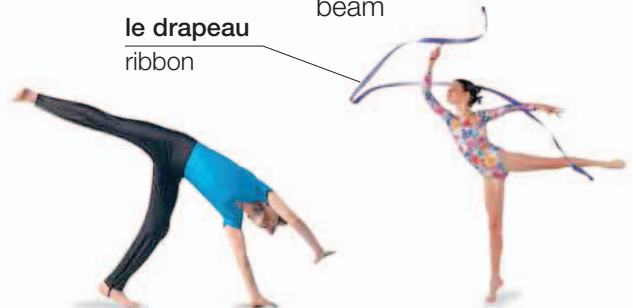

**la cabriole**  
tumble

**la gymnastique rythmique**  
rhythmic gymnastics

**vocabulaire • vocabulary**

**la barre fixe**  
horizontal bar

**le cheval d'arçons**  
pommel horse

**les anneaux**  
rings

**les médailles**  
medals

**l'argent**  
silver

**les barres parallèles**  
parallel bars

**les barres asymétriques**  
asymmetric bars

**le podium**  
podium

**l'or**  
gold

**le bronze**  
bronze

# les sports de combat • combat sports

**l'adversaire**  
opponent

**le protège-tête**  
guard

**le gant**  
glove

**la ceinture**  
belt



**le karaté**  
karate



**le judo**  
judo

**le taekwondo**  
tae kwon do

**le masque**  
mask

**le sabre**  
sword



**l'aïkido**  
aikido



**le kendo**  
kendo



**le kung-fu**  
kung fu



**la boxe thaïlandaise**  
kickboxing

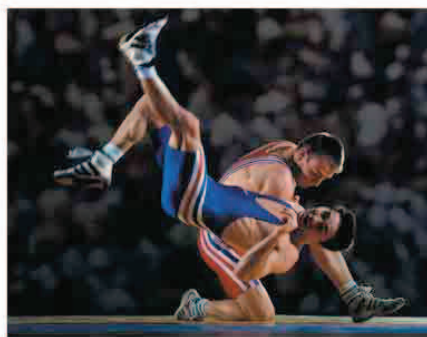

**la lutte**  
wrestling



**la boxe**  
boxing

les actions • actions



la chute  
fall



la prise  
hold



la projection  
throw



l'immobilisation  
pin



le coup de pied  
kick



le coup de poing  
punch



le coup  
strike



le coup  
chop



le saut  
jump



le blocage  
block

vocabulaire • vocabulary

le ring  
boxing ring

le round  
round

le poing  
fist

la ceinture noire  
black belt

la capoeira  
capoeira

les gants de boxe  
boxing gloves

le combat  
bout

le knock-out  
knockout

l'autodéfense  
self-defense

le sumo  
sumo wrestling

le protège-dents  
mouth guard

l'entraînement  
sparring

le punching-bag  
punching bag

les arts martiaux  
martial arts

le tai chi  
tai chi

# la natation • swimming

## l'équipement • equipment



la brassière  
armband



les lunettes protectrices  
goggles

la pince pour le nez  
nose clip



la planche  
kickboard



le maillot de bain  
swimsuit

le couloir  
lane

l'eau  
water

le plot de  
départ  
starting block



la piscine  
swimming pool

le bonnet de  
natation  
cap



le slip de bain  
trunks

le nageur | swimmer

le tremplin  
springboard

le plongeur  
diver



plonger | dive (v)



nager | swim (v)



le tour | turn



## les styles • styles



**le crawl**  
front crawl



**la brasse**  
breaststroke



**le dos crawlé** | backstroke

**la nage**  
stroke



**le coup de pied**  
kick

**le papillon** | butterfly

## la plongée • scuba diving

**la combinaison  
de plongée**  
wetsuit

**la palme**  
flipper

**la ceinture de  
plomb**  
weight belt



**la bouteille d'air**  
air cylinder

**le masque**  
mask

**le régulateur**  
regulator

**le tuba**  
snorkel

## vocabulaire • vocabulary

<b>le plongeon</b> dive	<b>nager sur place</b> tread water (v)	<b>les casiers</b> lockers	<b>le water-polo</b> water polo	<b>le petit bassin</b> shallow end	<b>la crampe</b> cramp
<b>le plongeon de haut vol</b> high dive	<b>le départ plongé</b> racing dive	<b>le maître nageur</b> lifeguard	<b>le grand bassin</b> deep end	<b>la nage synchronisée</b> synchronized swimming	<b>se noyer</b> drown (v)

# la voile • sailing



le compas  
compass



l'ancre  
anchor

le taquet  
cleat

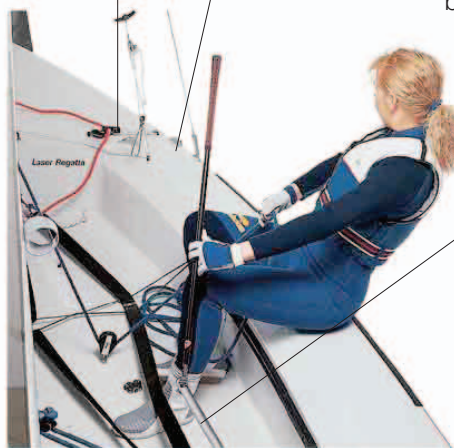

naviguer | navigate (v)

le pont de côté  
sidedeck

la voile d'avant  
headsail

l'avant  
bow

la barre  
tiller

la coque  
hull



le mât  
mast

le gréement  
rigging

la grand-voile  
mainsail

la bôme  
boom

l'arrière  
stern

le yacht | yacht

# la sécurité • safety



la fusée éclairante  
flare



la bouée de sauvetage  
life preserver



le gilet de sauvetage  
life jacket



le radeau de sauvetage  
life raft

# les sports aquatiques • watersports



le rameur  
rower

la rame  
oar

ramer | row (v)



le kayak  
kayak

la pagaie  
paddle

le canoë  
canoeing



la voile  
sail

le planchiste  
windsurfer

la planche  
board

la planche  
surfboard

la bride  
footstrap

la planche à voile | windsurfing



le surf  
surfing



le ski  
ski

le ski nautique  
waterskiing



le motonautisme  
speedboating



le rafting  
rafting



le jet-ski  
jet-skiing

## vocabulaire • vocabulary

le skieur nautique  
waterskier

l'équipage  
crew

le vent  
wind

l'écume  
surf

l'écoute  
sheet

la dérive  
centerboard

le surfeur  
surfer

louvoyer  
tack (v)

la vague  
wave

les rapides  
rapids

le gouvernail  
rudder

chavirer  
capsize (v)

# l'équitation • horseback riding

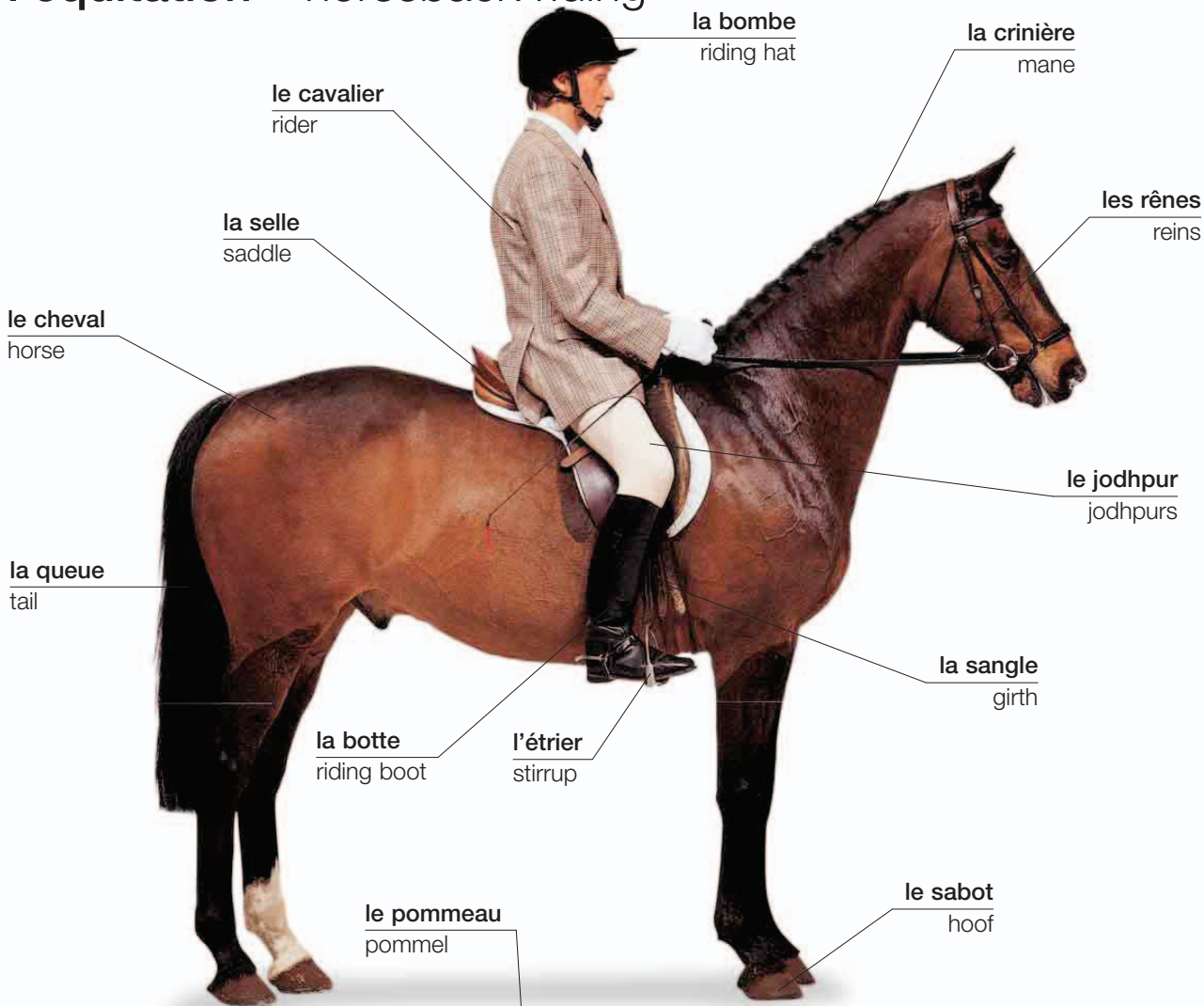

**le fer à cheval**  
horseshoe

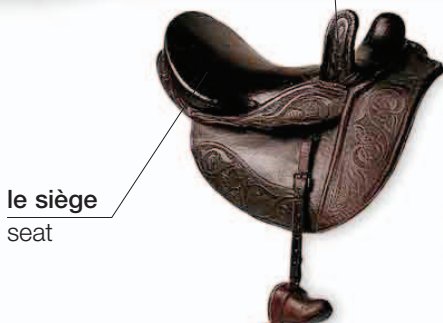

**le siège**  
seat

**la selle de femme**  
side-saddle

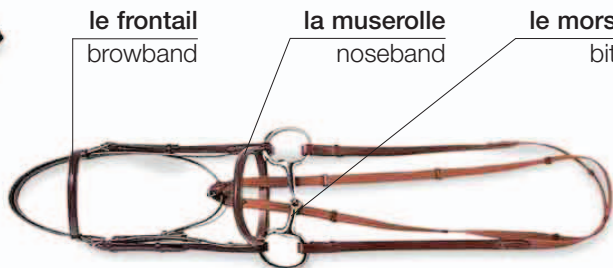

**le frontail**  
browband

**la muserolle**  
noseband

**le mors**  
bit

**la bride** | bridle

**la cravache** | riding crop

## les courses • events

le cheval de course  
racehorse



la course de chevaux  
horse race

l'obstacle  
fence



le steeple  
steeplechase



la course de trot  
harness race



le rodéo  
rodeo



le jumping  
showjumping



la course attelée  
carriage race



la randonnée  
trail-riding



le dressage  
dressage



le polo  
polo

### vocabulaire • vocabulary

le pas  
walk

le petit galop  
canter

le saut  
jump

le licou  
halter

l'enclos  
paddock

la course de plat  
flat race

le trot  
trot

le galop  
gallop

le valet d'écurie  
groom

l'écurie  
stable

l'arène  
arena

le champs de  
courses  
racecourse

# la pêche • fishing



le plomb | sinker

le barbillon  
barb

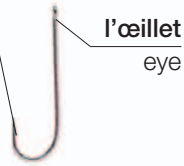

l'œillet  
eye



l'amorce | bait



l'épuisette  
landing net



le flotteur  
float



l'appât  
lure



la mouche  
fly



la boîte d'équipement  
tackle box



la bourriche  
keep net

la canne à pêche  
fishing rod

le moulinet  
reel

les bottes  
de pêche  
waders

la ligne  
line

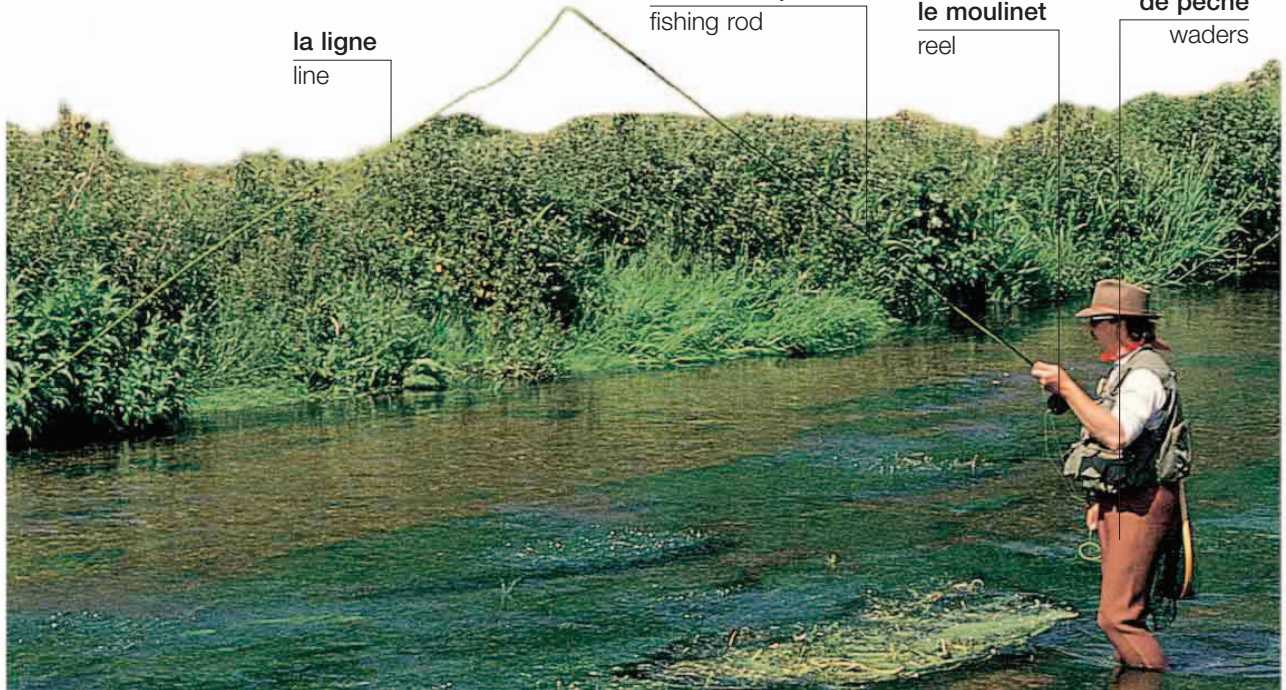

le pêcheur | angler

## les genres de pêche • types of fishing



la pêche en eau douce  
freshwater fishing



la pêche à la mouche  
fly fishing

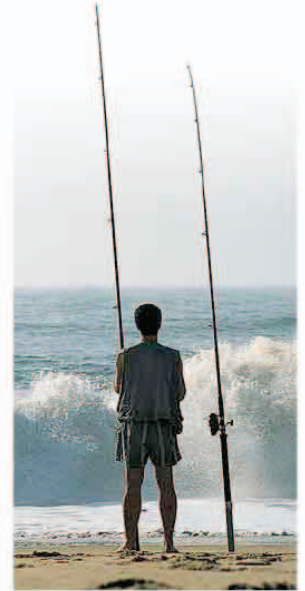

la pêche au lancer  
en mer  
surfcasting



la pêche sportive  
sport fishing



la pêche hauturière  
deep sea fishing

## les activités • activities

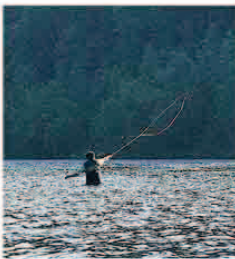

lancer  
cast (v)

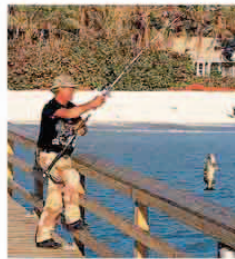

attraper  
catch (v)



ramener  
reel in (v)



prendre au filet  
net (v)



lâcher  
release (v)

## vocabulaire • vocabulary

amorcer  
bait (v)

le matériel de pêche  
tackle

l'imperméable  
rain gear

le permis de pêche  
fishing permit

le panier de pêche  
creel

mordre  
bite (v)

le tambour  
spool

la perche  
pole

la pêche maritime  
marine fishing

la pêche sous-marine  
spearfishing

# le ski • skiing

la pente de ski  
ski slope

le télésiège  
chairlift

la télécabine  
cable car

la veste de ski  
ski jacket



le bâton de ski  
ski pole

le gant  
glove

la piste de ski  
ski run

la barrière de sécurité  
safety barrier

la pointe  
tip

la carre  
edge

le ski  
ski

la veste de ski  
ski jacket

la skieuse  
skier

la chaussure de ski  
ski boot



les épreuves • events



la descente  
downhill skiing



la porte  
gate

le slalom  
slalom



le saut  
ski jump



le ski de randonnée  
cross-country skiing

les sports d'hiver • winter sports



l'escalade en glace  
ice climbing



le patinage  
ice-skating



le patinage artistique  
figure skating

les lunettes de ski  
goggles



le surf des neiges  
snowboarding

le patin  
à glace  
skate



le bobsleigh  
bobsled



la luge  
luge



l'autoneige  
snowmobile



la luge  
sledding

vocabulaire • vocabulary

le ski alpin  
alpine skiing

le traîneau à chiens  
dog-sledding

le slalom géant  
giant slalom

le patinage de vitesse  
speed skating

hors piste  
off-piste

le biathlon  
biathlon

le curling  
curling

l'avalanche  
avalanche

# les autres sports • other sports

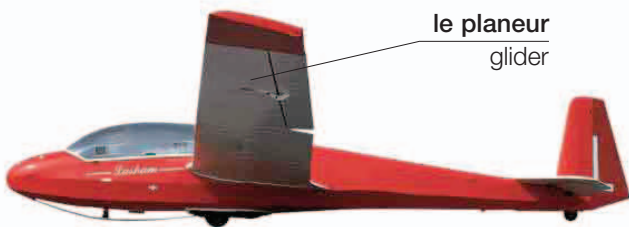

le planeur  
glider

le deltaplane  
hang-glider



le deltaplane  
hang-glider

le vol plané  
gliding

le parachute  
parachute



la corde  
rope

l'escalade  
rock-climbing



le parachutisme  
parachuting



le parapente  
paragliding



le saut en chute libre  
skydiving



le rappel  
rappelling

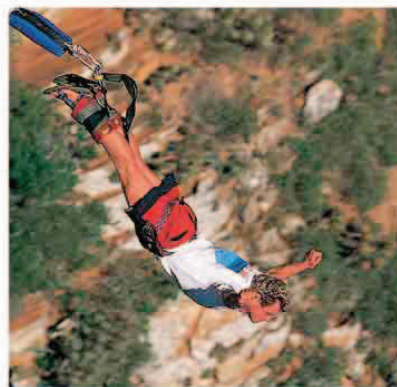

le saut à l'élastique  
bungee jumping



**le rallye**  
rally driving



**la course automobile**  
auto racing

**le coureur automobile**  
race-car driver



**le motocross**  
motocross



**la course de moto**  
motorcycle racing



**la planche à roulettes**  
skateboarding

**la planche à roulettes**  
skateboard



**le patin en ligne**  
inline skating

**la crosse**  
stick



**le lacrosse**  
lacrosse

**le masque**  
mask



**l'escrime**  
fencing

**le fleuret**  
foil

**la quille**  
pin



**le bowling**  
bowling

**la flèche**  
arrow

**le carquois**  
quiver



**le tir à l'arcx**  
archery

**la cible**  
target



**le tir à cible**  
target shooting

**la boule de bowling**  
bowling ball



**le billard américain**  
pool



**le billard**  
snooker

# le conditionnement physique • fitness

le vélo  
d'entraînement  
exercise bike

l'appareil de gym  
gym machine

le banc  
bench

les poids  
free weights

la barre  
bar



la machine  
à ramer  
rowing machine

le gymnase  
gym



le tapis roulant  
treadmill



la machine de  
randonnée  
cross-trainer



l'entraîneuse  
individuelle  
personal trainer



l'escalier  
d'entraînement  
step machine



la piscine  
swimming pool



le sauna  
sauna

les exercices • exercises



**l'étirement**  
stretch



**la fente en avant**  
lunge

**le collant**  
tights



**la traction**  
push-up



**la flexion de jambes**  
squat



**le redressement assis**  
sit-up



**l'exercice pour les biceps**  
biceps curl

**l'haltère**  
dumbbell



**la traction pour les jambes**  
leg press



**l'exercice pour la poitrine**  
chest press



**la barre à poids**  
weight bar

**les baskets**  
athletic shoes

**l'entraînement poids et haltères**  
weight training



**le jogging**  
jogging



**le Pilates**  
Pilates

**vocabulaire** • vocabulary

**s'entraîner**  
train (v)

**jogger sur place**  
jog in place (v)

**étendre**  
extend (v)

**l'aérobixe**  
boxercise

**l'entraînement en circuit**  
circuit training

**s'échauffer**  
warm up (v)

**fléchir**  
flex (v)

**tirer**  
pull up (v)

**le saut à la corde**  
rope-jumping



**le temps libre**  
leisure

# le théâtre • theater



le rideau  
curtain

les coulisses  
wings

le décor  
set

le public  
audience

l'orchestre  
orchestra

la scène | stage

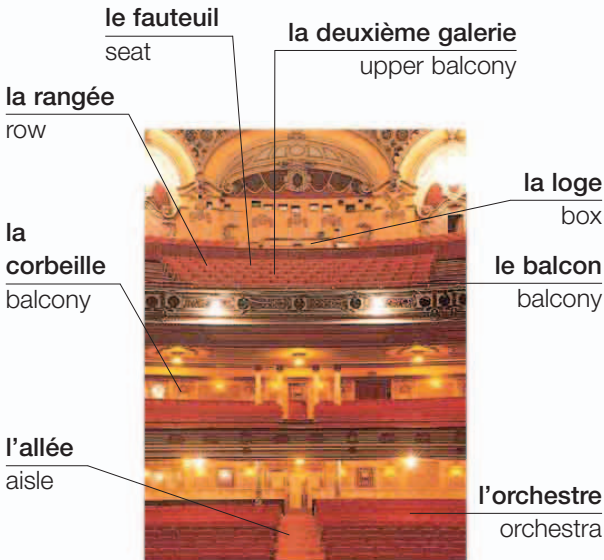

le fauteuil  
seat

la deuxième galerie  
upper balcony

la rangée  
row

la corbeille  
balcony

l'allée  
aisle

la loge  
box

le balcon  
balcony

l'orchestre  
orchestra

les places | seating

## vocabulaire • vocabulary

la distribution  
cast

le texte  
script

la première  
opening night

l'acteur  
actor

la toile de fond  
backdrop

l'entracte  
intermission

l'actrice  
actress

le metteur en  
scène  
director

le programme  
program

la pièce de  
théâtre  
play

le metteur en  
scène  
producer

la fosse  
d'orchestre  
orchestra pit





**le concert**  
concert



**la comédie musicale**  
musical

**le costume**  
costume

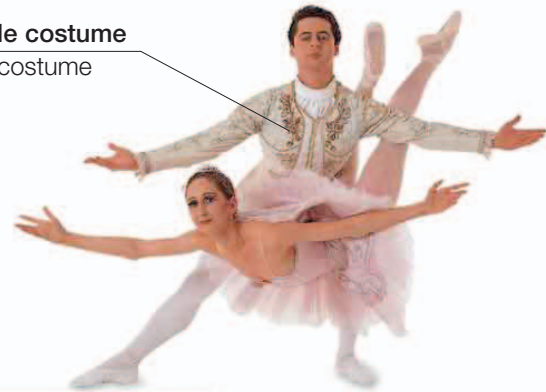

**le ballet**  
ballet



**l'opéra**  
opera

**vocabulaire • vocabulary**

**le placeur**  
usher

**la bande sonore**  
soundtrack

**Ça commence à quelle heure?**  
What time does it start?

**la musique classique**  
classical music

**applaudir**  
applaud (v)

**Je voudrais deux billets pour la représentation de ce soir.**  
I'd like two tickets for tonight's performance.

**la partition**  
musical score

**le bis**  
encore

**le cinéma • cinema**

**le pop-corn**  
popcorn



**le foyer**  
lobby

**la caisse**  
box office

**l'affiche**  
poster



**la salle de cinéma**  
movie theater



**l'écran**  
screen

**vocabulaire • vocabulary**

**la comédie**  
comedy

**la comédie romantique**  
romance

**le thriller**  
thriller

**le film de science-fiction**  
science fiction movie

**le film d'horreur**  
horror movie

**le film d'aventures**  
adventure

**le western**  
Western

**le film d'animation**  
animated film

# l'orchestre • orchestra

## les cordes • strings



le piano | piano

la partition  
score

la clé de fa  
bass clef



la notation | notation

### vocabulaire • vocabulary

l'ouverture  
overture

la sonate  
sonata

le silence  
rest

le dièse  
sharp

le bémol  
natural

la gamme  
scale

la symphonie  
symphony

les instruments  
instruments

le ton  
pitch

le bémol  
flat

la barre de  
mesure  
bar

la baguette  
baton

**les bois • woodwind**



**le piccolo**  
piccolo



**la flûte traversière**  
flute



**le hautbois**  
oboe



**le cor anglais**  
cor anglais



**le saxophone**  
saxophone



**la clarinette**  
clarinet



**la clarinette**  
bass clarinet



**le basson**  
bassoon



**le contrebasson**  
double bassoon

**la percussion • percussion**



**la timbale**  
kettle drum



**le gong**  
gong

**le vibraphone**  
vibraphone



**les pédales**  
foot pedals



**les bongos**  
bongos



**la caisse claire**  
snare drum



**les cymbales**  
cymbals



**le tambour**  
tambourine



**le triangle**  
triangle



**les maracas**  
maracas

**les cuivres • brass**



**la trompette**  
trumpet



**le trombone**  
trombone



**le cor**  
French horn



**le tuba**  
tuba

# le concert • concert



le concert de rock | rock concert

# les instruments • instruments

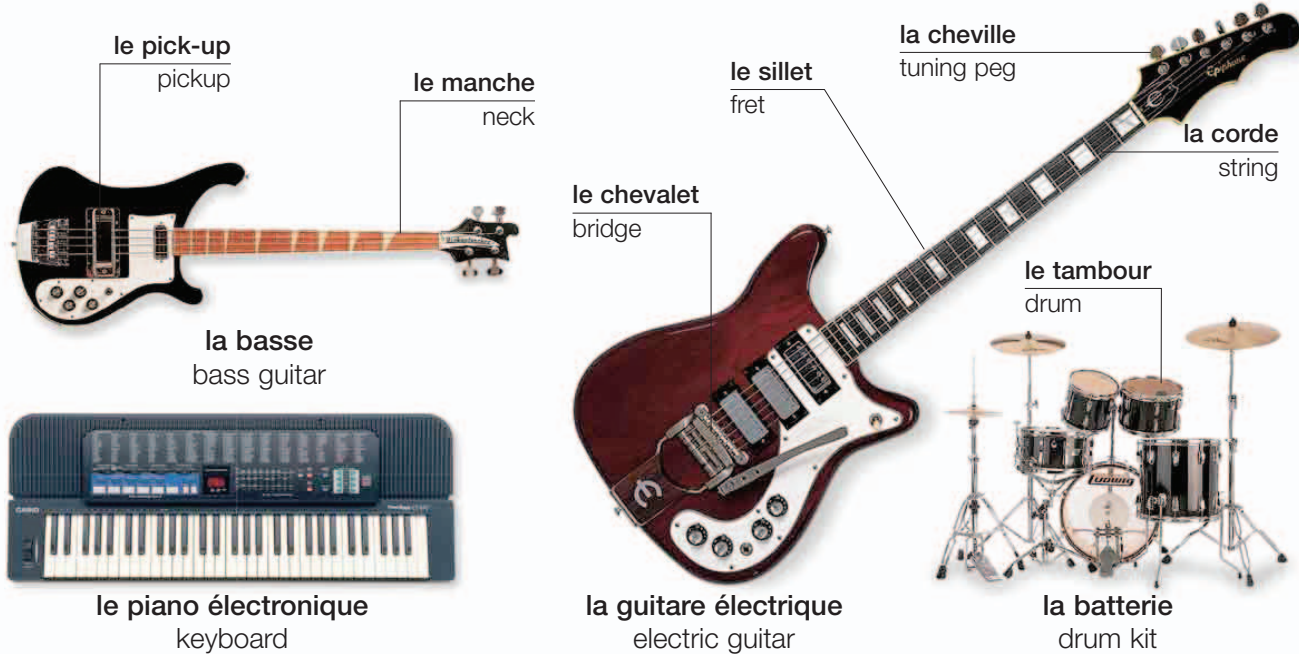

les styles de musique • musical styles



le jazz  
jazz



le blues  
blues



la musique punk  
punk



la musique folk  
folk music



la pop  
pop



la danse  
dance



le rap  
rap



la heavy métal  
heavy metal



la musique classique  
classical music

vocabulaire • vocabulary

la chanson  
song

les paroles  
lyrics

la mélodie  
melody

le beat  
beat

le reggae  
reggae

la country  
country

le projecteur  
spotlight

# le tourisme • sightseeing



le touriste  
tourist

l'attraction touristique | tourist attraction



l'itinéraire  
itinerary

à impériale  
open-top

le bus touristique | tour bus

la guide  
tour guide

la statuette  
figurine



la visite guidée  
guided tour



les souvenirs  
souvenirs

## vocabulaire • vocabulary

**ouvert**  
open

**le guide**  
guidebook

**le caméscope**  
camcorder

**à gauche**  
left

**Où est...?**  
Where is...?

**fermé**  
closed

**la pellicule**  
film

**l'appareil photo**  
camera

**à droite**  
right

**Je me suis perdu.**  
I'm lost.

**le prix d'entrée**  
admission  
charge

**les piles**  
batteries

**les directions**  
directions

**tout droit**  
straight  
ahead

**Pour aller à..., s'il vous plaît?**  
Can you tell me the way to....?

les attractions • attractions

le tableau  
painting

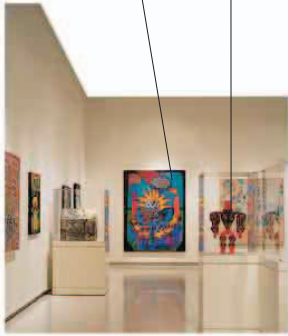

le musée d'art  
art gallery

l'objet exposé  
exhibit

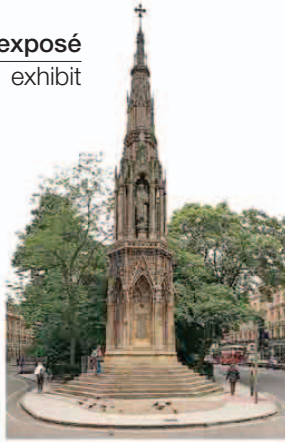

le monument  
monument

l'exposition  
exhibition

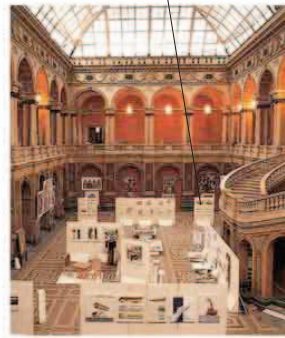

le musée  
museum

la ruine célèbre  
famous ruin



le monument  
historique  
historic building



le casino  
casino



le parc  
gardens



le parc national  
national park

l'information • information

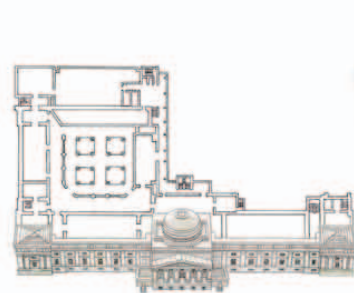

le plan  
floor plan



le plan  
map

les heures  
times



l'horaire  
schedule



l'information  
touristique  
tourist information

# les activités de plein air • outdoor activities

le sentier  
footpath

le cadran solaire  
sundial

le café  
café



le parc | park

la pelouse  
grass

le banc  
bench

les jardins à la  
française  
formal gardens

les montagnes  
russes  
roller coaster



la foire  
fairground



le parc d'attractions  
theme park



la réserve  
safari park



le zoo  
zoo



## les activités • activities



**le vélo**  
cycling



**le jogging**  
jogging



**la planche à roulette**  
skateboarding



**le roller**  
rollerblading

**la piste cavalière**  
bridle path



**l'observation des oiseaux**  
bird-watching



**l'équitation**  
horseback riding



**la randonnée**  
hiking

**le panier à pique-nique**  
hamper



**le pique-nique**  
picnic

## le terrain de jeux • playground



**le bac à sable**  
sandbox



**la pataugeoire**  
wading pool



**la balançoire**  
swing



**la bascule** | seesaw



**le toboggan**  
slide



**la cage à poules**  
climbing frame

# la plage • beach

l'hôtel  
hotel

le parasol  
beach umbrella

la cabine de plage  
beach hut

le sable  
sand

la vague  
wave

la mer  
sea



le sac de plage  
beach bag

le bikini  
bikini



prendre un bain de soleil | sunbathe (v)



le maître nageur  
lifeguard

la tour de surveillance  
lifeguard tower



le pare-vent  
windbreak



la promenade  
boardwalk



le transat  
deck chair



les lunettes de soleil  
sunglasses



le chapeau de plage  
sun hat



la lotion solaire  
suntan lotion



l'écran total  
sunblock



le ballon de plage  
beach ball



la bouée  
inflatable ring

le maillot de bain  
swimsuit

la pelle  
shovel

le seau  
pail

le château de sable  
sandcastle

le coquillage  
shell



la serviette de plage  
beach towel

# le camping • camping



**les toilettes**  
restrooms

**les poubelles**  
waste disposal

**les douches**  
shower block

**le branchement électrique**  
electric hookup

**le double toit**  
flysheet

**le piquet**  
tent peg

**la corde**  
guy rope

**la caravane**  
camper

**le terrain de camping**  
campground

## vocabulaire • vocabulary

**camper**  
camp (v)

**l'emplacement**  
site

**le banc à pique-nique**  
picnic bench

**le charbon de bois**  
charcoal

**le bureau du chef**  
site manager's office

**monter une tente**  
pitch a tent (v)

**le hamac**  
hammock

**l'allume-feu**  
firelighter

**les emplacements libres**  
sites available

**le mât**  
tent pole

**le camping-car**  
camper van

**allumer un feu**  
light a fire (v)

**complet**  
full

**le lit de camp**  
camp bed

**la remorque**  
trailer

**le feu de camp**  
campfire



le spray contre les  
insects  
insect repellent



la lampe torche  
flashlight

la moustiquaire  
mosquito net



les sous-vêtements  
thermiques  
thermal underwear



les chaussures de  
marche  
walking boots



l'imperméable  
rain gear



le sac de couchage  
sleeping bag



le réchaud  
camping stove



le barbecue  
barbecue grill

le tapis de sol  
sleeping mat



le matelas pneumatique | air mattress

# les distractions à la maison • home entertainment



la radio numérique  
digital radio



l'iPod®  
iPod



le DVD  
DVD disk

le lecteur DVD  
DVD player



le lecteur CD  
CD player

la radio  
radio

l'amplificateur  
amplifier

les écouteurs  
headphones

l'étagère  
stand

la chaîne hi-fi  
stereo system

le tourne-disque  
record player



le baffle  
speaker

le support  
speaker stand



**le box**  
DTV converter box



**l'écran**  
screen

**le caméscope**  
camcorder

**l'ocilleton**  
eyecup



**l'antenne parabolique**  
satellite dish

**la télévision à écran plat**  
flatscreen TV



**la console**  
console

**l'avance rapide**  
fast-forward

**la pause**  
pause

**l'enregistrement**  
record

**la commande**  
controller



**le jeu vidéo** | video game

**le volume**  
volume

**le retour rapide**  
rewind

**la lecture**  
play

**l'arrêt**  
stop



**la télécommande**  
remote control

**vocabulaire** • vocabulary

**le CD**  
CD

**la publicité**  
advertisement

**le wifi**  
wifi

**la chaîne à péage**  
pay-per-view channel

**regarder la télévision**  
watch television (v)

**la cassette**  
cassette tape

**numérique**  
digital

**le programme**  
program

**changer de chaîne**  
change channels (v)

**éteindre la télévision**  
turn off the television (v)

**le lecteur cassettes**  
cassette player

**le streaming**  
streaming

**stéréo**  
stereo

**allumer la télévision**  
turn on the television (v)

**régler la radio**  
tune the radio (v)

**le film**  
feature film

**haute définition**  
high-definition

**la télévision par câble**  
cable television

# la photographie • photography

le déclencheur

shutter release

le réglage de l'ouverture

aperture dial

l'objectif

lens



l'appareil réflex mono-objectif | SLR camera



le filtre  
filter



le bouchon d'objectif  
lens cap



le trépied  
tripod



le flash compact  
flash gun



le posemètre  
light meter



le zoom  
zoom lens

## les types d'appareils photo • types of camera



le Polaroid®  
Polaroid camera



l'appareil photo APS  
APS camera

le flash  
flash



le photophone  
cameraphone



l'appareil jetable  
disposable camera



photographe • photographer (v)

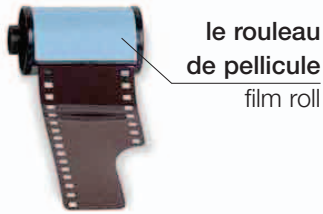

la pellicule  
film



mettre au point  
focus (v)



développer  
develop (v)



le négatif  
negative

paysage  
landscape



portrait  
portrait



la photo | photograph



l'album de photos  
photo album



le cadre de photo  
picture frame

les problèmes • problems

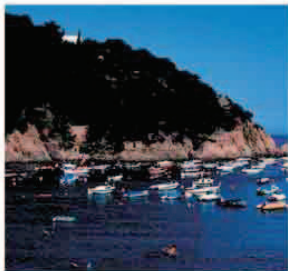

sous-exposé  
underexposed



surexposé  
overexposed



flou  
out of focus



la tache rouge  
red eye

vocabulaire • vocabulary

le viseur  
viewfinder

l'épreuve  
print

le sac d'appareil photo  
camera case

mat  
mat

la pose  
exposure

brilliant  
gloss

la chambre noire  
darkroom

l'agrandissement  
enlargement

Pourriez-vous faire développer cette pellicule?

I'd like this film processed.

# les jeux • games

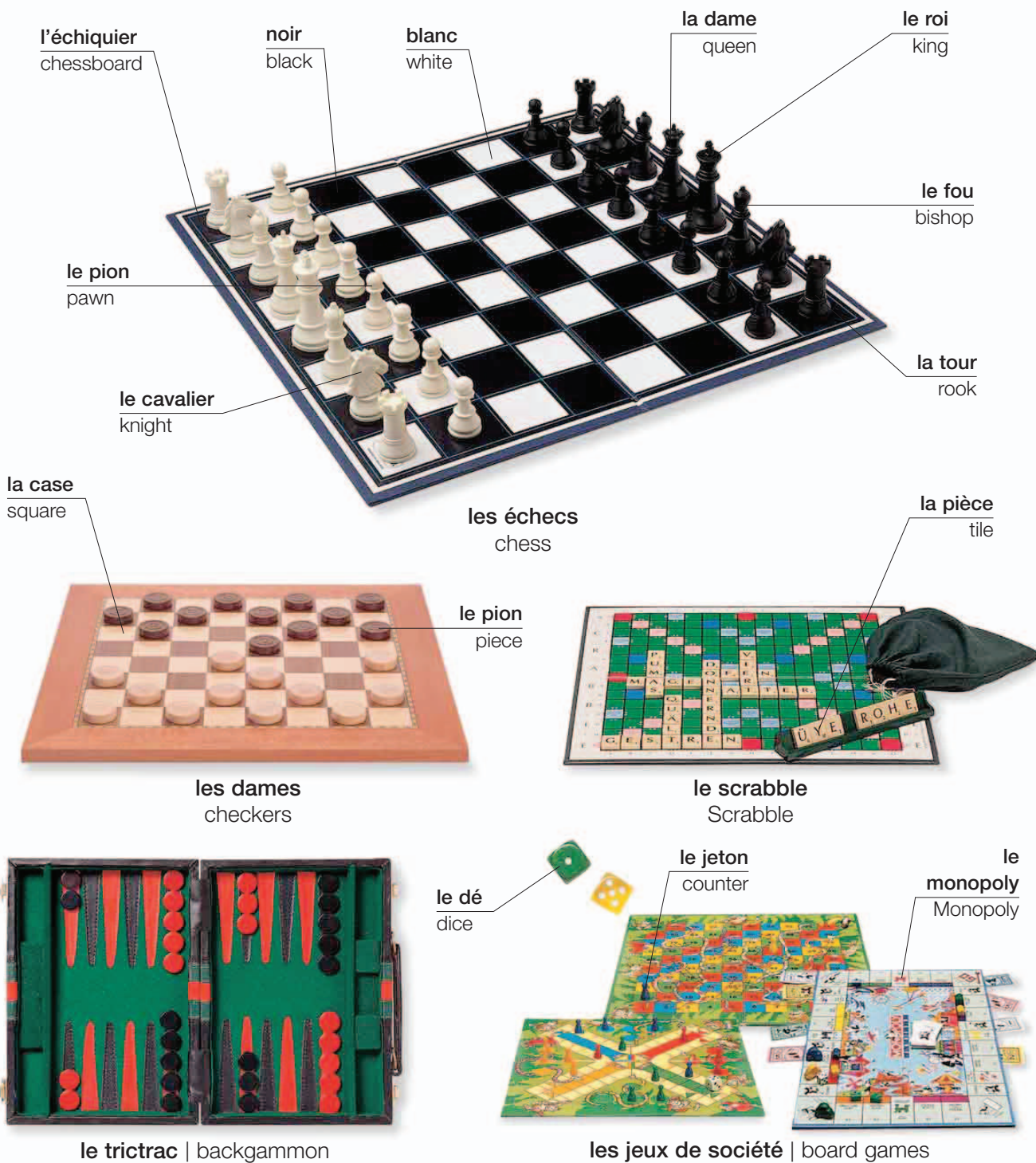



**la philatélie**  
stamp collecting



**le puzzle**  
jigsaw puzzle

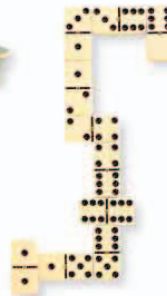

**les dominos**  
dominoes

**la cible**  
dartboard

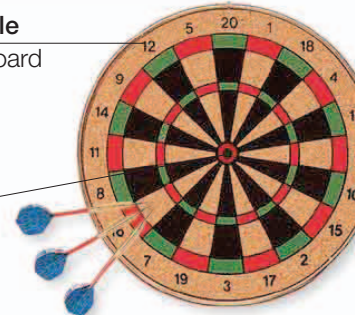

**le mille**  
bullseye

**les fléchettes**  
darts

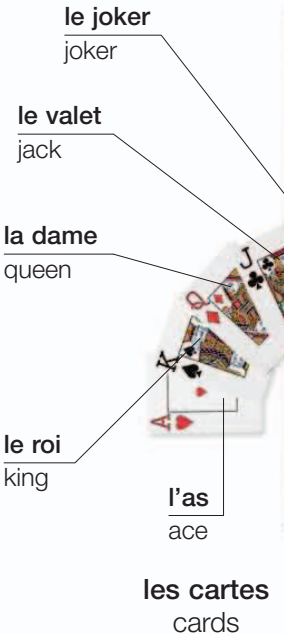

**le joker**  
joker

**le valet**  
jack

**la dame**  
queen

**le roi**  
king

**l'as**  
ace

**les cartes**  
cards



**le carreau**  
diamond

**le pique**  
spade

**le cœur**  
heart

**le trèfle**  
club



**battre** | shuffle (v)



**donner** | deal (v)

**vocabulaire** • vocabulary

**le coup**  
move

**gagner**  
win (v)

**le perdant**  
loser

**le point**  
point

**le bridge**  
bridge

**Jette le dé.**  
Roll the dice.

**jouer**  
play (v)

**le gagnant**  
winner

**le jeu**  
game

**la marque**  
score

**le jeu de cartes**  
deck of cards

**C'est à qui de jouer?**  
Whose turn is it?

**le joueur**  
player

**perdre**  
lose (v)

**le pari**  
bet

**le poker**  
poker

**la couleur**  
suit

**C'est à toi de jouer.**  
It's your move.

# les arts et métiers 1 • arts and crafts 1

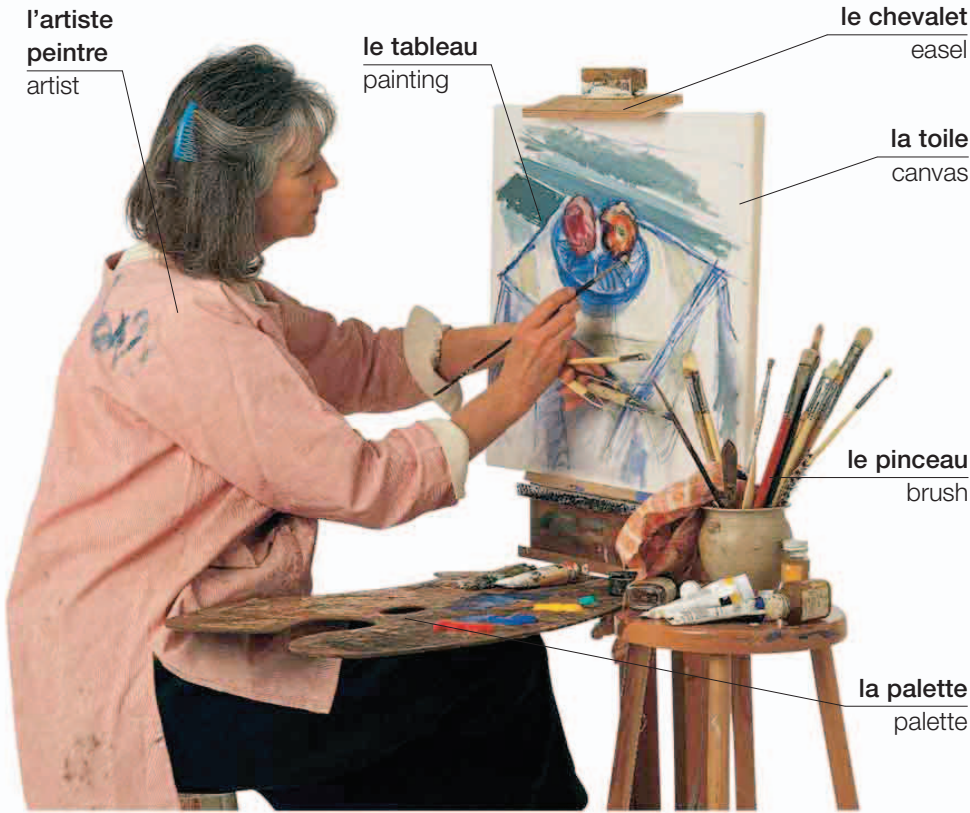

la peinture | painting

## les couleurs • paints



les peintures à l'huile  
oil paints



l'aquarelle  
watercolor paint



les pastels  
pastels



l'acrylique  
acrylic paint



la gouache  
poster paint

## les couleurs • colours

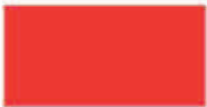

rouge  
red



bleu  
blue



jaune  
yellow



vert  
green



orange  
orange



violet  
purple



blanc  
white



noir  
black

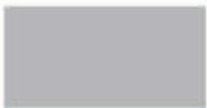

gris  
gray



rose  
pink



marron  
brown



indigo  
indigo

les autres arts • other crafts

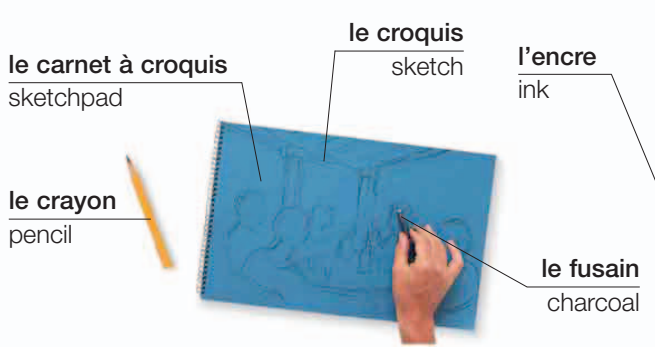

le dessin | drawing



l'imprimerie  
printing



la gravure  
engraving

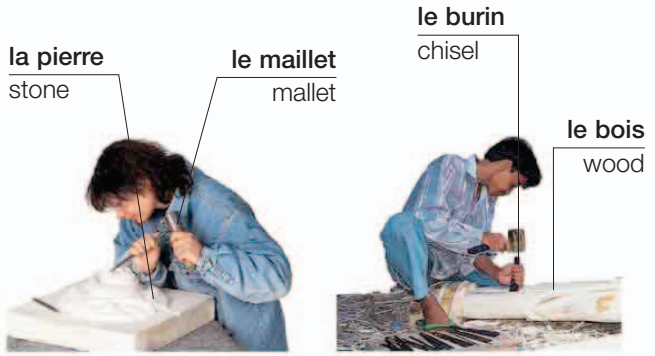

la sculpture  
sculpting

la sculpture sur bois  
woodworking



la poterie  
pottery



le collage | collage

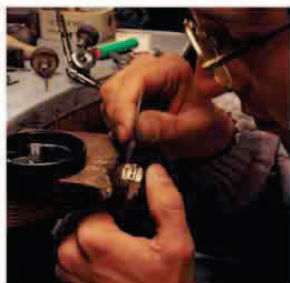

la joaillerie  
jewelry-making



le papier mâché  
papier-mâché



l'origami  
origami



le modélisme  
model-making

# les arts et métiers 2 • arts and crafts 2



la machine à coudre | sewing machine





**enfiler**  
thread (v)



**coudre**  
sew (v)



**repriser**  
darn (v)



**bâtir**  
tack (v)



**couper**  
cut (v)



**la tapisserie**  
needlepoint



**la broderie**  
embroidery

**le crochet**  
crochet hook



**le crochet**  
crochet



**le macramé**  
macramé



**le patchwork**  
patchwork



**le ouatage**  
quilting



**la dentelle**  
lace-making



**le tissage**  
weaving

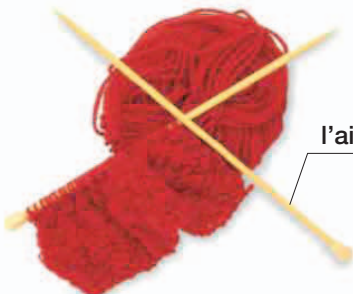

**le tricot** | knitting

**l'aiguille à tricoter**  
knitting needle



**l'écheveau** | skein

**la laine**  
wool

**vocabulaire** • vocabulary

**défaire**  
unpick (v)

**le nylon**  
nylon

**le tissu**  
fabric

**la soie**  
silk

**le coton**  
cotton

**le styliste**  
designer

**le lin**  
linen

**la moda**  
fashion

**le polyester**  
polyester

**la fermeture éclair**  
zip







**l'environnement**  
environnement



[WWW.EBOOK777.COM](http://WWW.EBOOK777.COM)

# l'espace • space

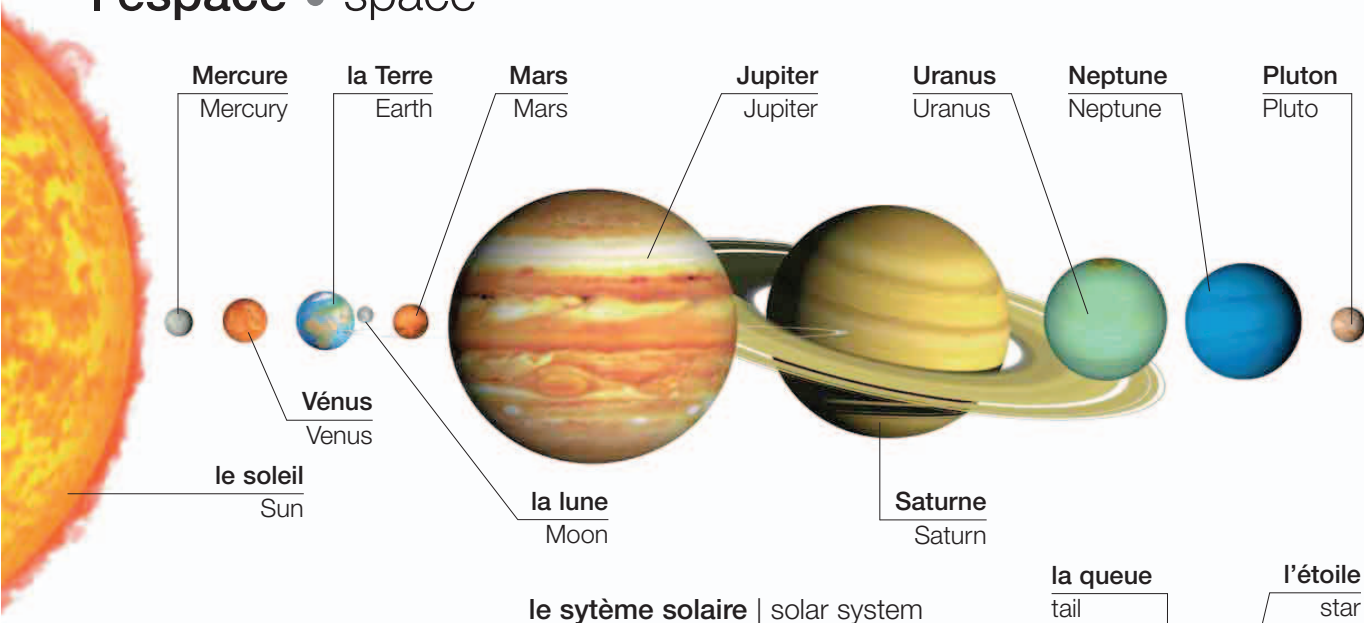

la galaxie  
galaxy



la nébuleuse  
nebula



l'astéroïde  
asteroid

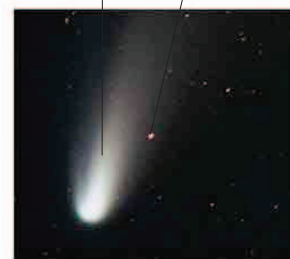

la comète  
comet

## vocabulaire • vocabulary

**l'univers**  
universe

**le trou noir**  
black hole

**la pleine lune**  
full moon

**l'orbite**  
orbit

**la planète**  
planet

**la nouvelle lune**  
new moon

**la pesanteur**  
gravity

**le météore**  
meteor

**le croissant  
de lune**  
crescent moon



l'éclipse | eclipse

# l'exploration spatiale • space exploration



la navette spatiale  
space shuttle

l'accélérateur  
booster

le scaphandre spatial  
space suit



l'astronaute | astronaut

la rampe de lancement  
launch pad

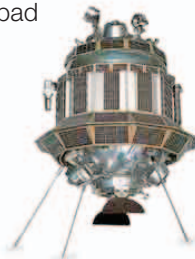

le satellite  
satellite

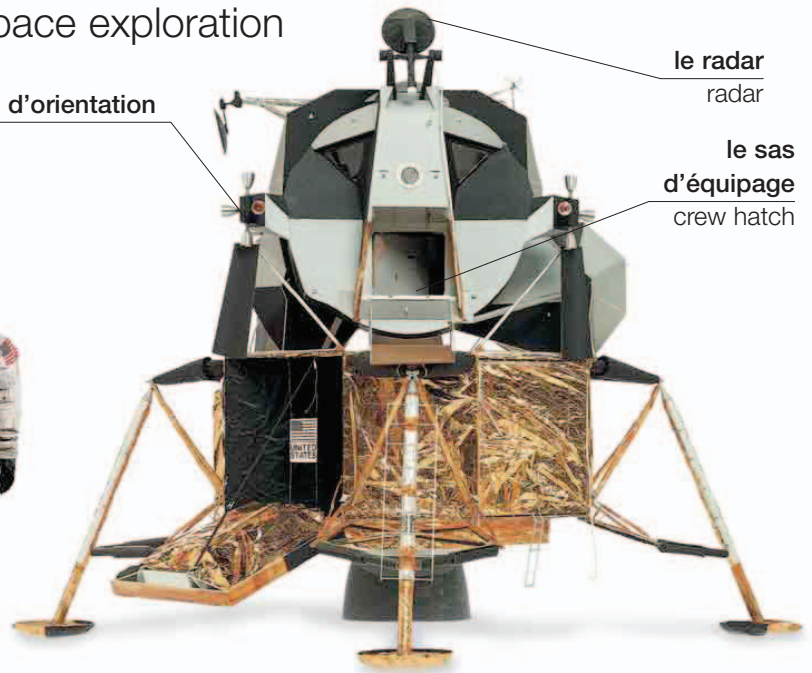

le module lunaire | lunar module

le radar  
radar

le sas d'équipage  
crew hatch



la station spatiale  
space station

# l'astronomie • astronomy



la constellation  
constellation



les jumelles  
binoculars



le télescope  
telescope

le trépied  
tripod

# la terre • Earth

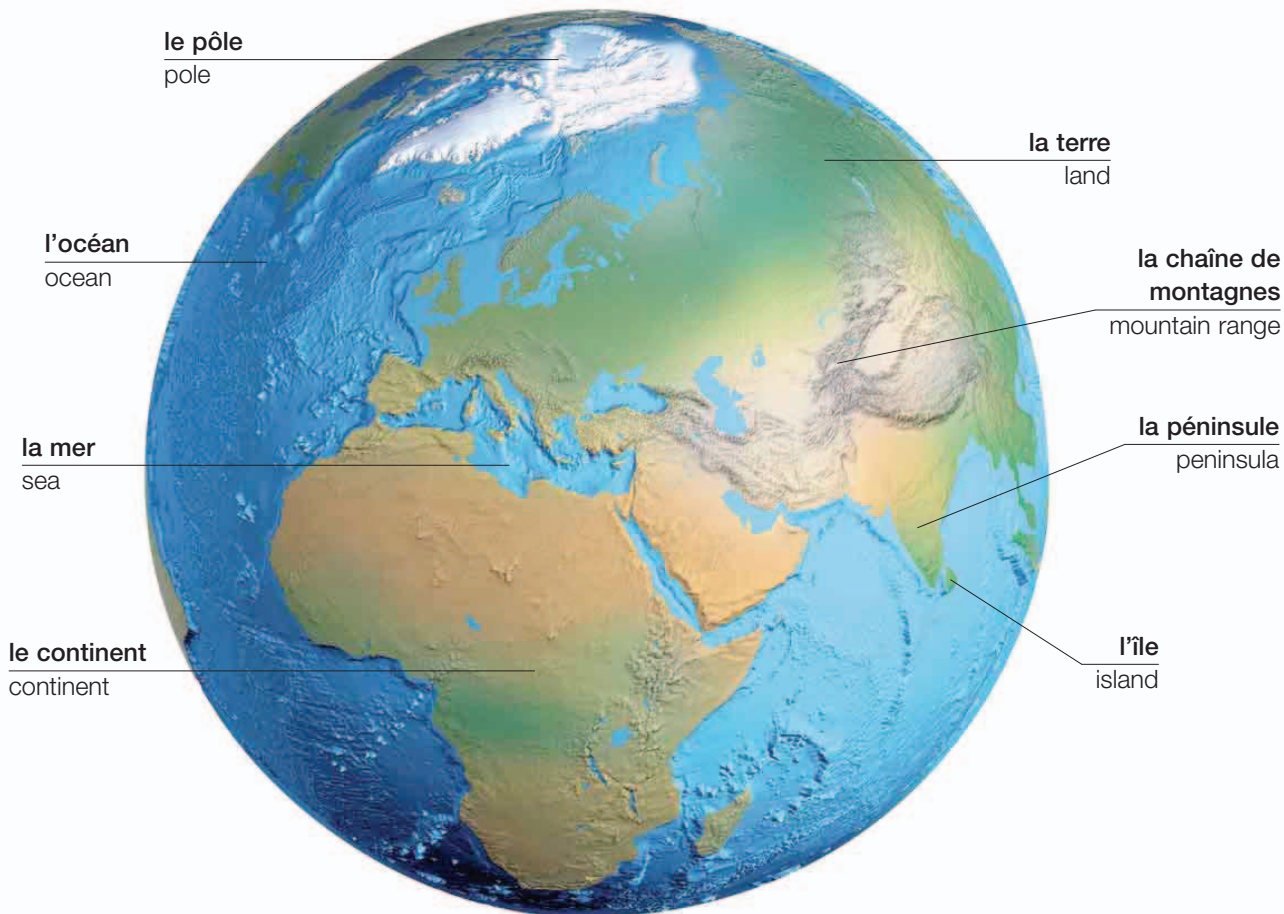

la planète | planet

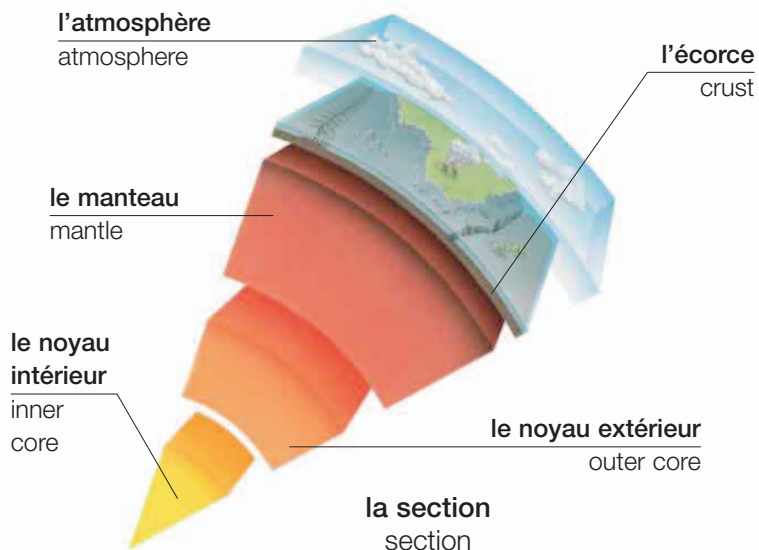

**le cercle polaire arctique**

Arctic circle

**le tropique du cancer**

tropic of Cancer

**les tropiques**

tropics

**le tropique du capricorne**

tropic of Capricorn

**le pôle nord**

North Pole

**l'hémisphère nord**

northern hemisphere

**la longitude**

longitude

**la latitude**

latitude

**l'hémisphère sud**

southern hemisphere

**l'équateur**

equator

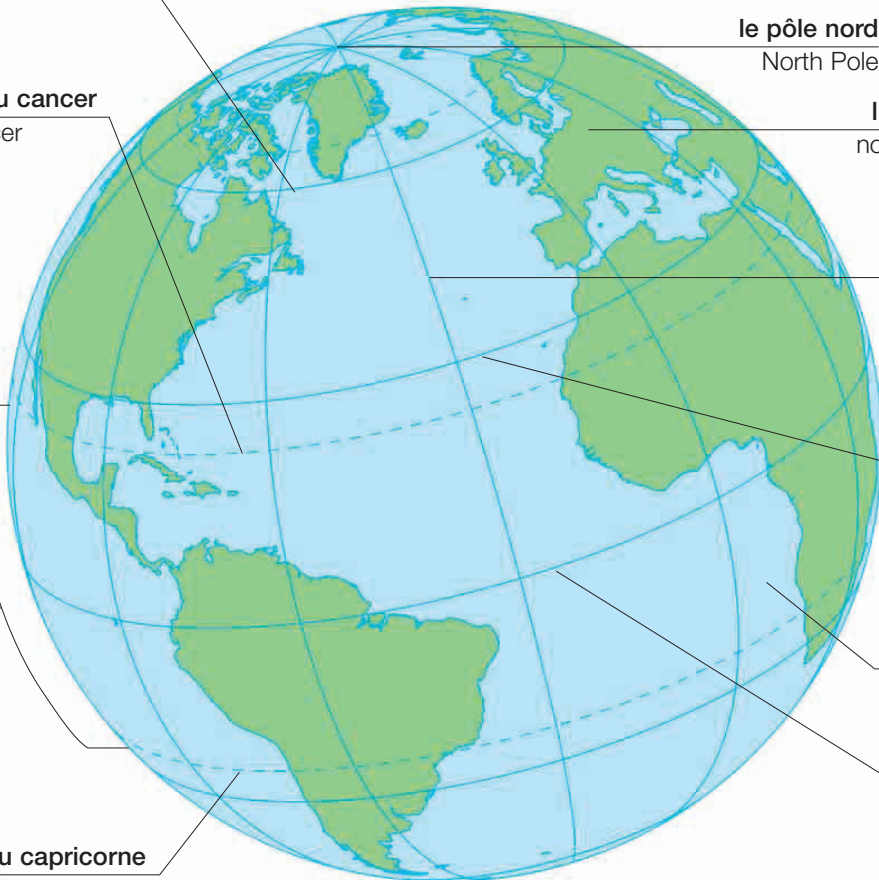

**les zones | zones**

**vocabulaire**

• vocabulary

**le**

**tremblement**

**de terre**

earthquake

**la plaque**

plate

**entrer en**

**éruption**

erupt (v)

**le**

**tremblement**

tremor

**la lave**

lava

**la cendre**

ash

**la cheminée**

vent

**la chambre**

chamber

**le magma**

magma

**le volcan | volcano**

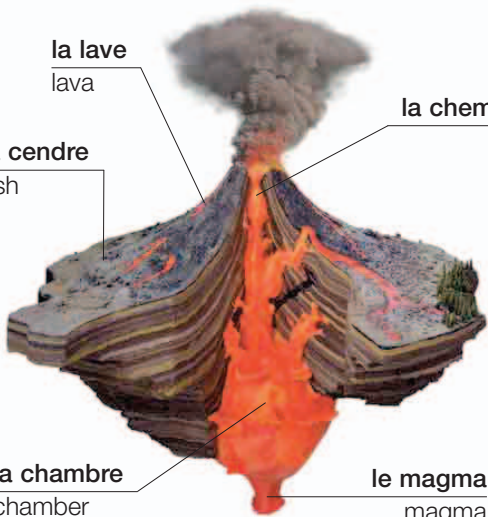

**le cratère | crater**

# le paysage • landscape

la montagne  
mountain

la pente  
slope

la rive  
bank

la rivière  
river

les rapides  
rapids

les rochers  
rocks

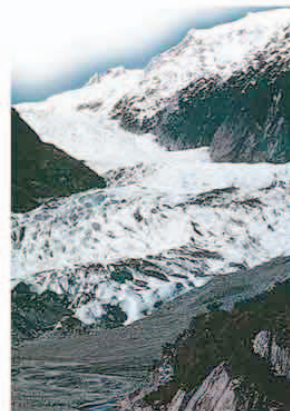
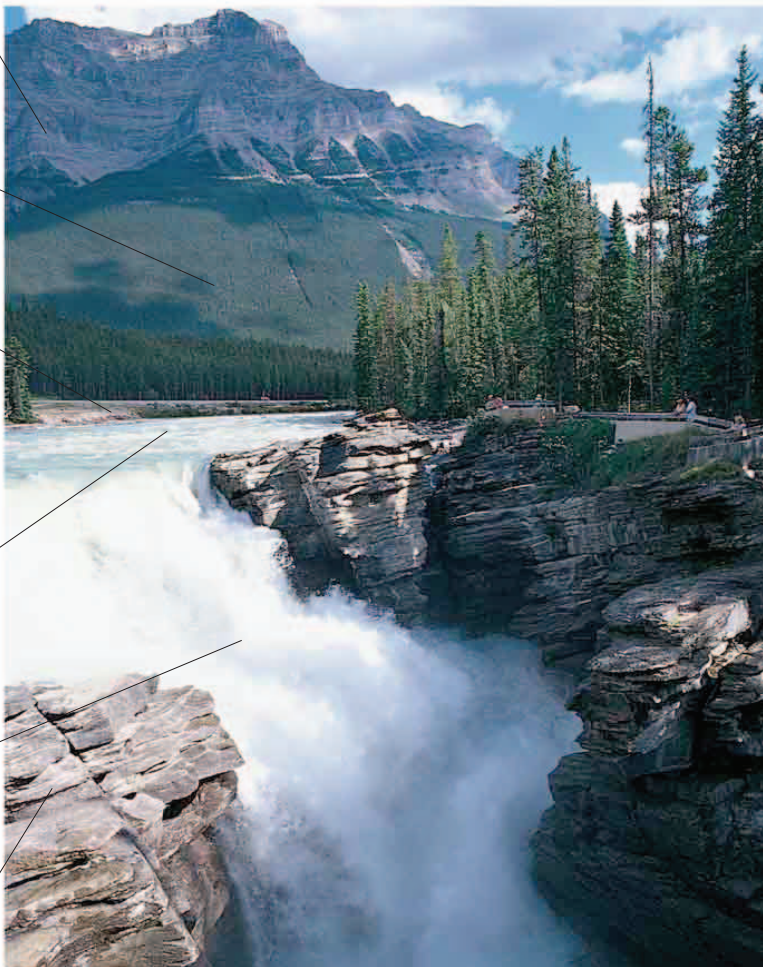

le glacier  
glacier

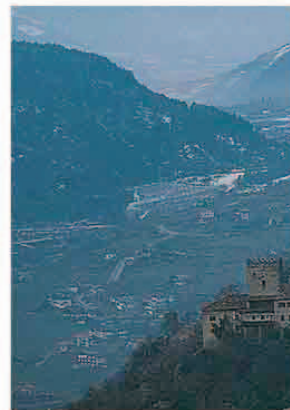

la vallée | valley



la colline  
hill



le plateau  
plateau



la gorge  
gorge

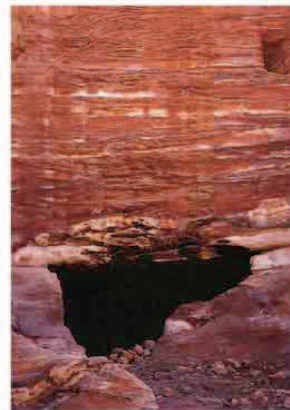

la caverne  
cave



**la plaine** | plain



**le désert** | desert



**la forêt** | forest



**le bois** | woods



**la forêt tropicale**  
rainforest



**le marais**  
swamp



**le pré**  
meadow



**la prairie**  
grassland



**la cascade**  
waterfall



**le ruisseau**  
stream



**le lac**  
lake



**le geyser**  
geyser



**la côte**  
coast

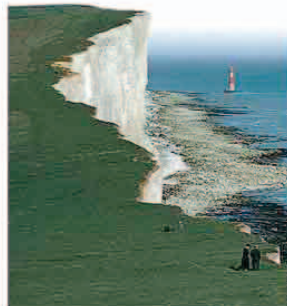

**la falaise**  
cliff



**le récif de corail**  
coral reef



**l'estuaire**  
estuary

# le temps • weather

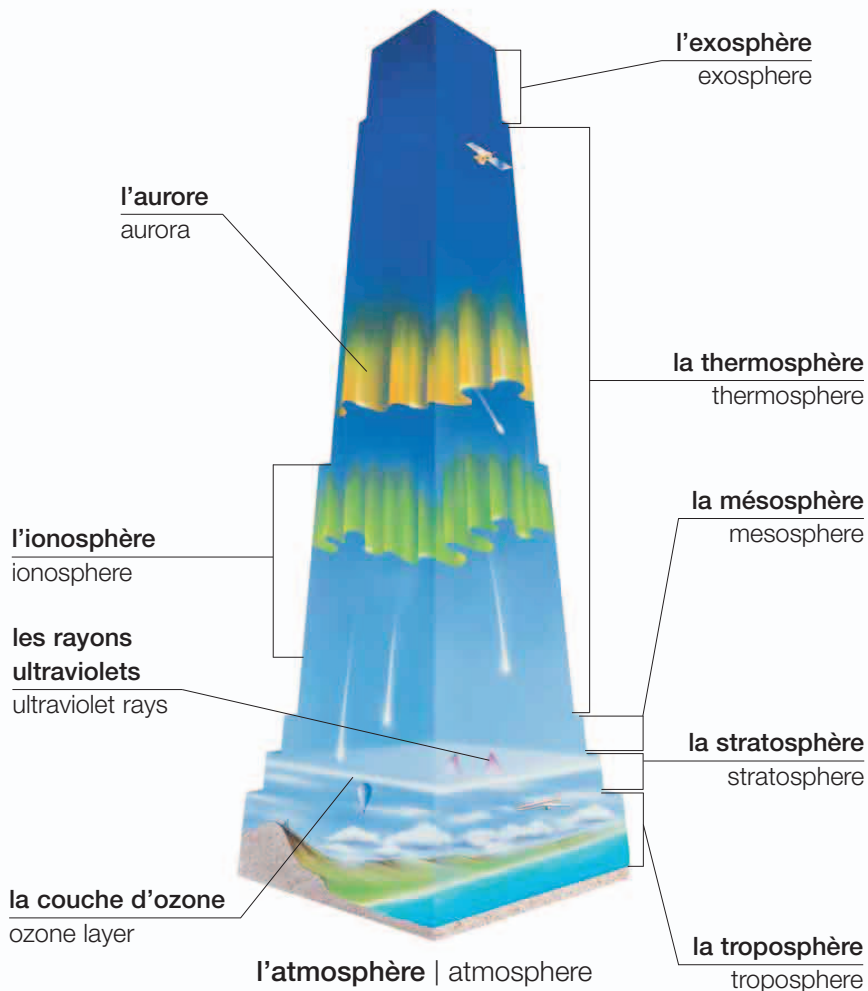

**le soleil**  
sunshine



**le vent**  
wind

## vocabulaire • vocabulary

**la neige fondue**  
sleet

**l'averse**  
shower

**(très) chaud**  
hot

**sec**  
dry

**venteux**  
windy

**J'ai chaud/froid.**  
I'm hot/cold.

**la grêle**  
hail

**ensoleillé**  
sunny

**froid**  
cold

**humide**  
wet

**la tempête**  
gale

**Il pleut.**  
It's raining.

**le tonnerre**  
thunder

**nuageux**  
cloudy

**chaud**  
warm

**lourd**  
humid

**la température**  
temperature

**Il fait ... degrés.**  
It's ... degrees.





**le nuage**  
cloud



**la pluie**  
rain

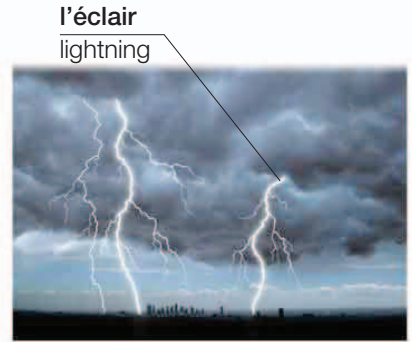

**l'éclair**  
lightning

**l'orage**  
storm



**la brume**  
mist



**le brouillard**  
fog



**l'arc-en-ciel**  
rainbow



**la neige**  
snow



**le givre**  
frost



**la glace**  
ice



**le glaçon**  
icicle

**le gel**  
freeze



**l'ouragan**  
hurricane



**la tornade**  
tornado



**la mousson**  
monsoon



**l'inondation**  
flood

# les roches • rocks

## igné • igneous



le granit  
granite

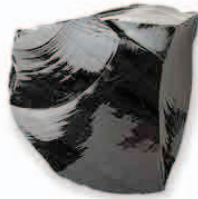

l'obsidienne  
obsidian



le basalte  
basalt



la pierre ponce  
pumice

## sédimentaire • sedimentary



le grès  
sandstone



le calcaire  
limestone



la craie  
chalk



le silex  
flint



le conglomérat  
conglomerate



le charbon  
coal

## métamorphique •

## metamorphic



l'ardoise  
slate



le schiste  
schist



le gneiss  
gneiss

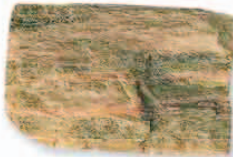

le marbre  
marble

## les gemmes • gems

le rubis  
ruby



l'aigue-marine  
aquamarine



l'améthyste  
amethyst



le  
diamant  
diamond



le jade  
jade

le jais  
jet



l'émeraude  
emerald

l'opale  
opal



le saphir  
sapphire

la pierre de  
lune  
moonstone

le grenat  
garnet



le topaze  
topaz

la tourmaline  
tourmaline



## les minéraux • minerals



**le quartz**  
quartz



**le mica**  
mica



**le soufre**  
sulfur



**l'hématite**  
hematite



**la calcite**  
calcite



**la malachite**  
malachite



**la turquoise**  
turquoise



**l'onyx**  
onyx

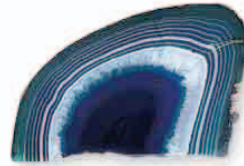

**l'agate**  
agate



**le graphite**  
graphite

## les métaux • metals



**l'or**  
gold

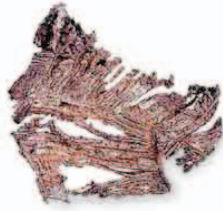

**l'argent**  
silver



**le platine**  
platinum



**le nickel**  
nickel



**le fer**  
iron



**le cuivre**  
copper



**l'étain**  
tin



**l'aluminium**  
aluminum



**le mercure**  
mercury

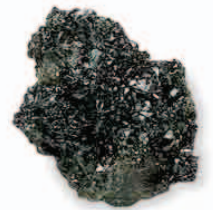

**le zinc**  
zinc

# les animaux 1 • animals 1

## les mammifères • mammals



**le lapin**  
rabbit

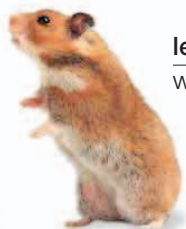

**le hamster**  
hamster

les poils  
whiskers



**la souris**  
mouse

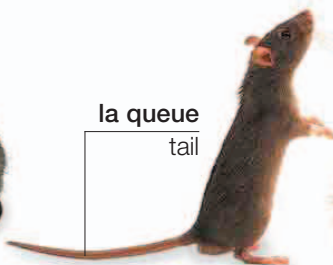

la queue  
tail

**le rat**  
rat



**le hérisson**  
hedgehog



**l'écureuil**  
squirrel



**la chauve-souris**  
bat



**le raton laveur**  
raccoon



**le renard**  
fox



**le loup**  
wolf

le chiot  
puppy



**le chien**  
dog

le chaton  
kitten



**le chat**  
cat

le bébé-phoque  
pup



**la loutre**  
otter



**le phoque**  
seal



**l'otarie**  
sea lion

la nageoire  
flipper

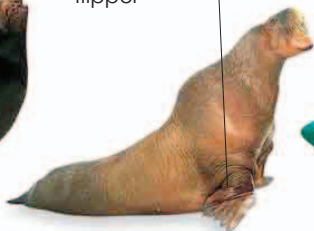

**le morse**  
walrus

l'évent  
blowhole



**la baleine**  
whale



**le dauphin**  
dolphin



la ramure  
antler

le cerf  
deer

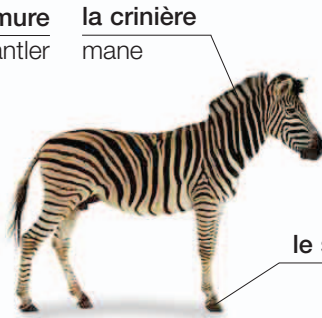

la crinière  
mane

le sabot  
hoof

le zèbre  
zebra



la girafe  
giraffe



la bosse  
hump

le chameau  
camel



la trompe  
trunk

l'hippopotame  
hippopotamus

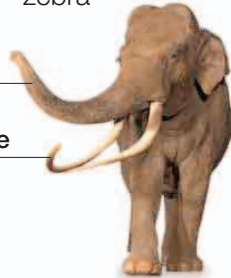

la défense  
tusk

l'éléphant  
elephant



la corne  
horn

le rhinocéros  
rhinoceros



le tigre  
tiger



la crinière  
mane

le lion  
lion



le singe  
monkey



le gorille  
gorilla



le koala  
koala



la poche  
pouch

le kangourou  
kangaroo



l'ours  
bear

la griffe  
claw



l'ours blanc  
polar bear



le panda  
panda

# les animaux 2 • animals 2

## les oiseaux • birds



**le canari**  
canary



**le moineau**  
sparrow



**le colibri**  
hummingbird



**l'hirondelle**  
swallow



**le corbeau**  
crow



**le pigeon**  
pigeon



**le pic**  
woodpecker



**le faucon**  
falcon



**la chouette**  
owl



**la mouette**  
gull



**l'aigle**  
eagle



**le pélican**  
pelican



**le flamant**  
flamingo



**la cigogne**  
stork



**la grue**  
crane



**le pingouin**  
penguin



**l'autruche**  
ostrich



l'oie | goose



le cygne  
swan

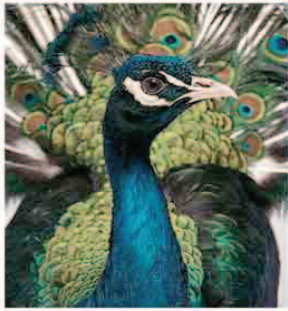

le paon  
peacock



le faisan  
pheasant



le dindon  
turkey



le bec  
bill

le cacatoès  
cockatoo



la plume  
feather

l'aile  
wing

la griffe  
claw

le perroquet  
parrot

## les reptiles • reptiles

les écailles  
scales



l'alligator  
alligator



le lézard  
lizard



l'iguane  
iguana



la tortue marine  
turtle



la tortue  
tortoise

la carapace  
shell

le serpent  
snake



le museau  
snout



le crocodile  
crocodile

# les animaux 3 • animals 3

## les amphibiens • amphibians



la grenouille  
frog



le crapaud  
toad



le têtard  
tadpole



la salamandre  
salamander

## les poissons • fish



l'anguille  
eel

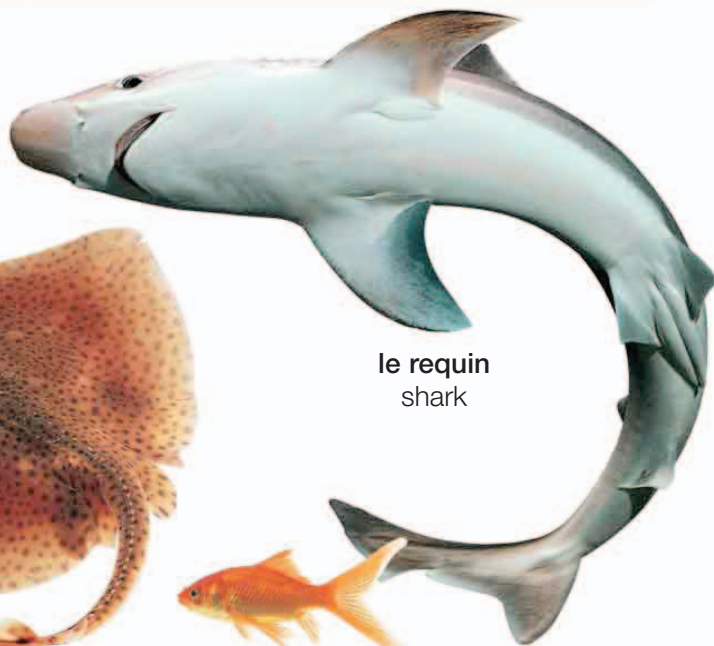

le requin  
shark



l'hippocampe  
sea horse



la raie  
skate



la raie  
ray



le poisson rouge  
goldfish

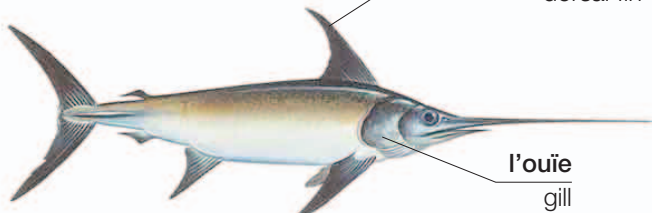

l'espardon  
swordfish

la nageoire dorsale  
dorsal fin

la nageoire pectorale  
pectoral fin

la queue  
tail

l'ouïe  
gill

l'écaille  
scale

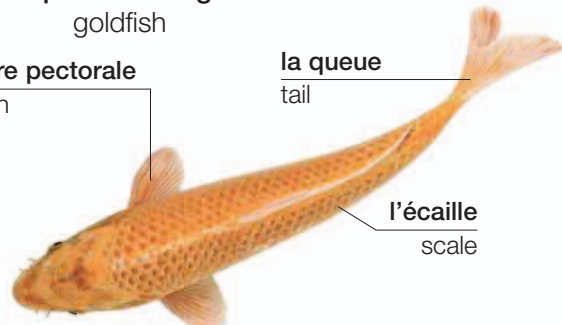

la carpe koi  
koi carp



## les invertébrés • invertebrates



la fourmi  
ant



la termite  
termite



l'abeille  
bee



la guêpe  
wasp



le scarabée  
beetle



le cafard  
cockroach



le papillon  
moth



le papillon  
butterfly

l'antenne  
antenna



le cocon  
cocoon



la chenille  
caterpillar



le grillon  
cricket



la sauterelle  
grasshopper



la mante religieuse  
praying mantis



le dard  
sting

le scorpion  
scorpion



le mille-pattes  
centipede



la libellule  
dragonfly



la mouche  
fly



le moustique  
mosquito



la coccinelle  
ladybug



l'araignée  
spider



la limace  
slug



l'escargot  
snail



le ver  
worm



l'étoile de mer  
starfish



la moule  
mussel



le crabe  
crab



le homard  
lobster



la pieuvre  
octopus



le calmar  
squid



la méduse  
jellyfish

# les plantes • plants

## l'arbre • tree

la branche  
branch

la racine  
root



la feuille  
leaf

la brindille  
twig

l'écorce  
bark

le tronc  
trunk



le saule  
willow

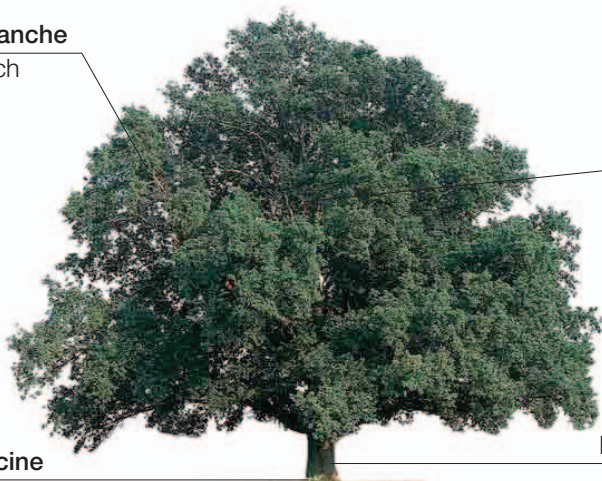

le chêne  
oak



le peuplier  
poplar



l'eucalyptus  
eucalyptus



le mélèze  
larch



le hêtre  
beech



le bouleau  
birch



le pin  
pine



le cèdre  
cedar



l'érable  
maple



l'orme  
elm



le tilleul  
lime



le houx  
holly

la baie  
berry



le palmier  
palm

la plante à fleurs • flowering plant

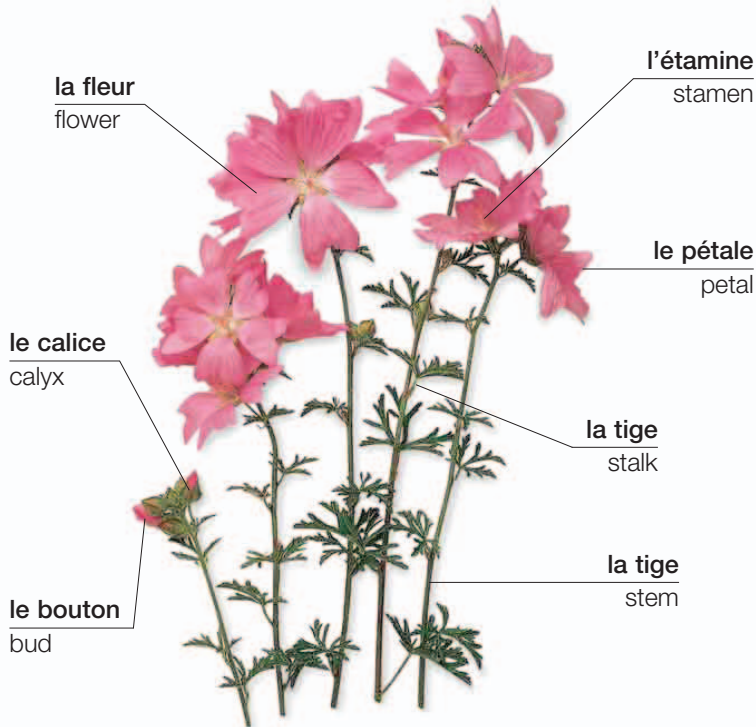

**la renoncule**  
buttercup



**la pâquerette**  
daisy



**le chardon**  
thistle



**le pissenlit**  
dandelion



**la bruyère**  
heather



**le coquelicot**  
poppy



**la digitale**  
foxglove



**le chèvrefeuille**  
honeysuckle



**le tournesol**  
sunflower



**le trèfle**  
clover



**les jacinthes  
des bois**  
bluebells



**la primevère**  
primrose



**les lupins**  
lupines



**l'ortie**  
nettle

# la ville • town



les bâtiments • buildings



la mairie  
town hall



la bibliothèque  
library



le cinéma  
movie theater



le théâtre  
theater



l'université  
university



le gratte-ciel  
skyscraper

les environs • areas



la zone industrielle  
industrial park



la ville  
city



l'école  
school



la banlieue  
suburb



le village  
village

vocabulaire • vocabulary

la zone piétonnière  
pedestrian zone

la rue transversale  
side street

la bouche d'égout  
manhole

le caniveau  
gutter

l'église  
church

l'avenue  
avenue

la place  
square

l'arrêt de bus  
bus stop

l'usine  
factory

l'égout  
drain

# l'architecture • architecture

## les bâtiments et structures • buildings and structures



**le gratte-ciel**  
skyscraper



**le château**  
castle



**l'église**  
church

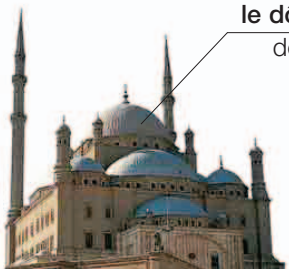

**la mosquée**  
mosque



**le temple**  
temple



**la synagogue**  
synagogue



**le barrage**  
dam



**le pont**  
bridge



**le fleuron**  
finial

**la tourelle**  
turret

**la flèche**  
spire

**la douve**  
moat

**le pignon**  
gable

**le dôme**  
dome

**la tour**  
tower

**la voûte**  
vault

**la corniche**  
cornice

**la colonne**  
pillar

**la cathédrale** | cathedral

# les styles • styles



gothique  
gothic

l'architrave  
architrave



Renaissance  
Renaissance



baroque  
baroque



l'arc  
arch

la frise  
frieze

le chœur  
choir

le fronton  
pediment

le contrefort  
buttress



rococo  
rococo



néoclassique  
neoclassical



art nouveau  
Art Nouveau



art déco  
Art Deco



[WWW.EBOOK777.COM](http://WWW.EBOOK777.COM)





**l'information**  
reference

[WWW.EBOOK777.COM](http://WWW.EBOOK777.COM)

# l'heure • time



**l'horloge**  
clock

## vocabulaire • vocabulary

<b>la seconde</b> second	<b>maintenant</b> now	<b>un quart d'heure</b> 15 minutes
<b>la minute</b> minute	<b>plus tard</b> later	<b>vingt minutes</b> twenty minutes
<b>l'heure</b> hour	<b>une demi-heure</b> half an hour	<b>quarante minutes</b> forty minutes

**Quelle heure est-il?**  
What time is it?

**Il est trois heures.**  
It's three o'clock.



**une heure cinq**  
five after one



**une heure dix**  
ten after one



**une heure et quart**  
quarter after one



**une heure vingt**  
twenty after one



**une heure vingt-cinq**  
twenty-five after one

**la trotteuse**  
second hand



**une heure trente**  
one-thirty



**deux heures moins vingt-cinq**  
twenty-five to two



**deux heures moins vingt**  
twenty to two



**deux heures moins le quart**  
quarter to two



**deux heures moins dix**  
ten to two



**deux heures moins cinq**  
five to two



**deux heures**  
two o'clock

# la nuit et le jour • night and day

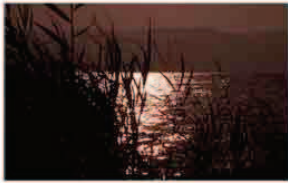

**minuit**  
midnight



**le lever du soleil**  
sunrise



**l'aube**  
dawn



**le matin**  
morning



**le coucher du soleil**  
sunset



**(le) midi**  
noon

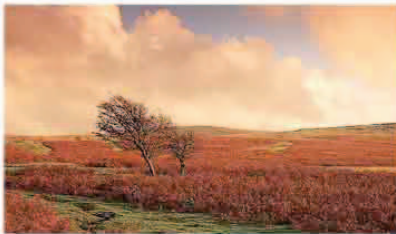

**le crépuscule**  
dusk



**le soir**  
evening



**l'après-midi**  
afternoon

## vocabulaire • vocabulary

**tôt**  
early

**Tu es en avance.**  
You're early.

**Sois à l'heure, s'il te plaît.**  
Please be on time.

**Ça finit à quelle heure?**  
What time does it end?

**à l'heure**  
on time

**Tu es en retard.**  
You're late.

**À tout à l'heure.**  
I'll see you later.

**Il se fait tard.**  
It's getting late.

**tard**  
late

**J'y arriverai bientôt.**  
I'll be there soon.

**Ça commence à quelle heure?**  
What time does it start?

**Ça dure combien de temps?**  
How long will it last?

# le calendrier • calendar

le mois  
month

l'an  
year

janvier  
January

2010



le jour  
day

lundi    mardi    mercredi    jeudi    vendredi    samedi    dimanche  
Monday    Tuesday    Wednesday    Thursday    Friday    Saturday    Sunday

le jour ouvrable  
work day

1	2	3	4	5	6	7
8	9	10	11	12	13	14
15	16	17	18	19	20	21

la semaine  
week

la date  
date

hier  
yesterday

aujourd'hui  
today

demain  
tomorrow

le week-end  
weekend

## vocabulaire • vocabulary

janvier  
January

mars  
March

mai  
May

juillet  
July

septembre  
September

novembre  
November

février  
February

avril  
April

juin  
June

août  
August

octobre  
October

décembre  
December

## les ans • years

**1900** mille neuf cents • nineteen hundred

**1901** mille neuf cent un • nineteen hundred and one

**1910** mille neuf cent dix • nineteen ten

**2000** deux mille • two thousand

**2001** deux mille un • two thousand and one

## les saisons • seasons



**le printemps**  
spring



**l'été**  
summer



**l'automne**  
fall



**l'hiver**  
winter

## vocabulaire • vocabulary

**le siècle**  
century

**la décennie**  
decade

**le millénaire**  
millennium

**cette semaine**  
this week

**la semaine dernière**  
last week

**la semaine prochaine**  
next week

**avant-hier**  
the day before yesterday

**après-demain**  
the day after tomorrow

**hebdomadaire**  
weekly

**mensuel**  
monthly

**annuel**  
annual

.....  
**Quelle est la date aujourd'hui?**  
What's the date today?

**C'est le sept février deux mille deux.**  
It's February seventh, two thousand and two.

## les nombres • numbers

0	zéro • zero	20	vingt • twenty
1	un • one	21	vingt et un • twenty-one
2	deux • two	22	vingt-deux • twenty-two
3	trois • three	30	trente • thirty
4	quatre • four	40	quarante • forty
5	cinq • five	50	cinquante • fifty
6	six • six	60	soixante • sixty
7	sept • seven	70	soixante-dix • seventy
8	huit • eight	80	quatre-vingts • eighty
9	neuf • nine	90	quatre-vingt-dix • ninety
10	dix • ten	100	cent • one hundred
11	onze • eleven	110	cent dix • one hundred and ten
12	douze • twelve	200	deux cents • two hundred
13	treize • thirteen	300	trois cents • three hundred
14	quatorze • fourteen	400	quatre cents • four hundred
15	quinze • fifteen	500	cinq cents • five hundred
16	seize • sixteen	600	six cents • six hundred
17	dix-sept • seventeen	700	sept cents • seven hundred
18	dix-huit • eighteen	800	huit cents • eight hundred
19	dix-neuf • nineteen	900	neuf cents • nine hundred

1,000	mille • one thousand
10,000	dix mille • ten thousand
20,000	vingt mille • twenty thousand
50,000	cinquante mille • fifty thousand
55,500	cinquante-cinq mille cinq cents • fifty-five thousand five hundred
100,000	cent mille • one hundred thousand
1,000,000	un million • one million
1,000,000,000	un milliard • one billion

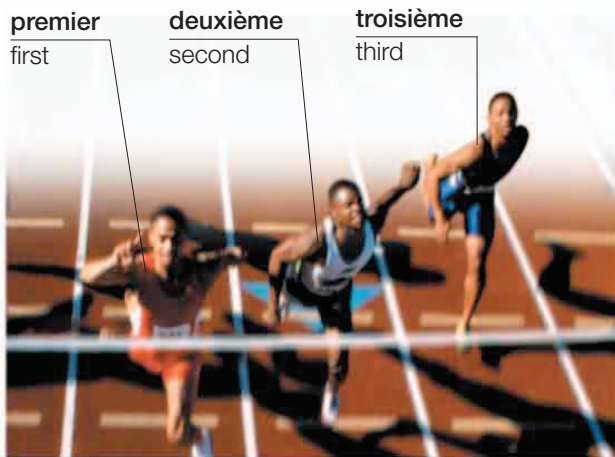

**premier**  
first

**deuxième**  
second

**troisième**  
third

**quatrième** • fourth

**cinquième** • fifth

**sixième** • sixth

**septième** • seventh

**huitième** • eighth

**neuvième** • ninth

**dixième** • tenth

**onzième** • eleventh

**douzième** • twelfth

**treizième** • thirteenth

**quatorzième** • fourteenth

**quinzième** • fifteenth

**seizième**  
• sixteenth

**dix-septième**  
• seventeenth

**dix-huitième**  
• eighteenth

**dix-neuvième**  
• nineteenth

**vingtième**  
• twentieth

**vingt et unième**  
• twenty-first

**vingt-deuxième**  
• twenty-second

**vingt-troisième**  
• twenty-third

**trentième** • thirtieth

**quarantième** • fortieth

**cinquantième** • fiftieth

**soixantième** • sixtieth

**soixante-dixième**  
• seventieth

**quatre-vingtième**  
• eightieth

**quatre-vingt-dixième**  
• ninetieth

**centième**  
• one hundredth

# les poids et mesures • weights and measures

## la superficie • area

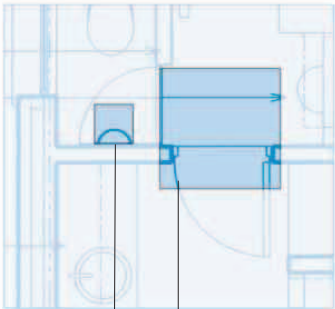

le pied carré  
square foot

le mètre carré  
square meter

## la distance • distance

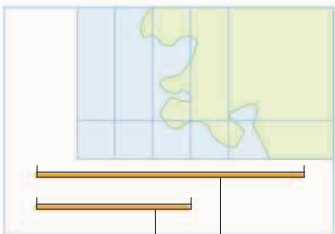

le kilomètre  
kilometer

le mile  
mile

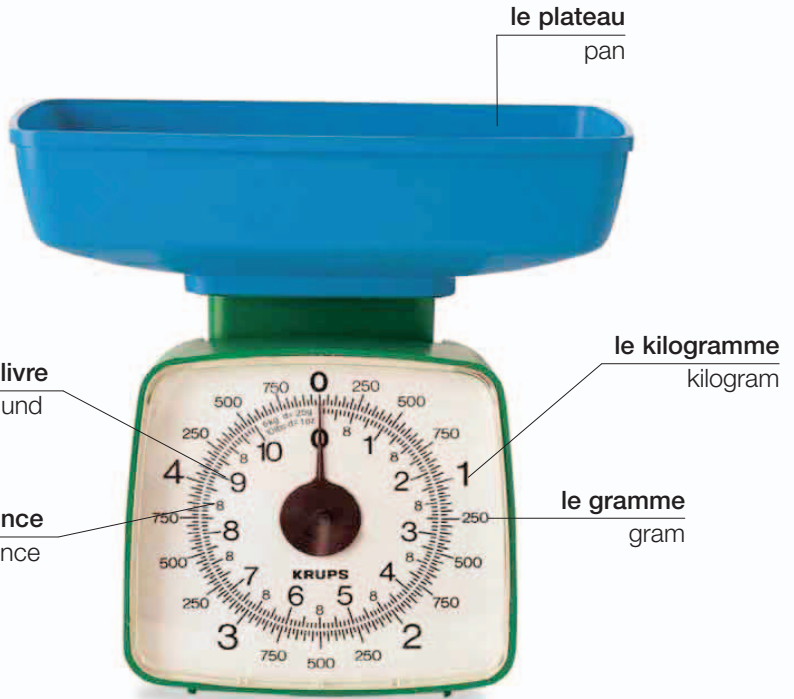

le plateau  
pan

la livre  
pound

l'once  
ounce

le kilogramme  
kilogram

le gramme  
gram

la balance | scale

## vocabulaire • vocabulary

le yard  
yard

la tonne  
ton

mesurer  
measure (v)

le mètre  
meter

le milligramme  
milligram

peser  
weigh (v)

## la longueur • length

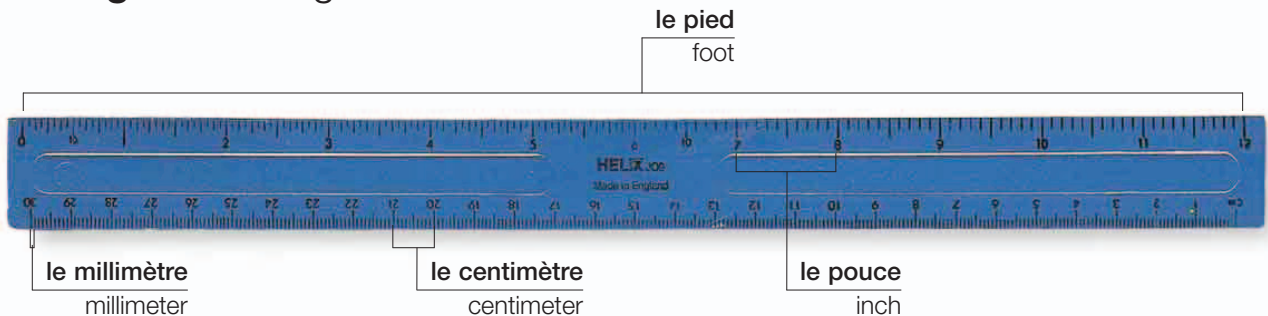

le pied  
foot

le millimètre  
millimeter

le centimètre  
centimeter

le pouce  
inch



**la capacité • capacity**

le demi-litre  
half-liter

la pinte  
pint

le volume  
volume

le millilitre  
milliliter



le verre mesureur  
measuring cup



la mesure pour les liquides  
liquid measure

**vocabulaire •**  
vocabulary

le gallon  
gallon

deux pintes  
quart

le litre  
liter

**le récipient • container**



la brique  
carton



le paquet  
packet



la bouteille  
bottle



le sac  
bag



le pot | tub



le pot | jar

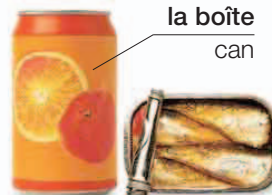

la boîte  
can

la boîte | tin



le pulvérisateur  
spray bottle



le pain  
bar



le tube  
tube



le rouleau  
roll



le paquet  
pack



la bombe  
spray can

# la carte du monde • world map

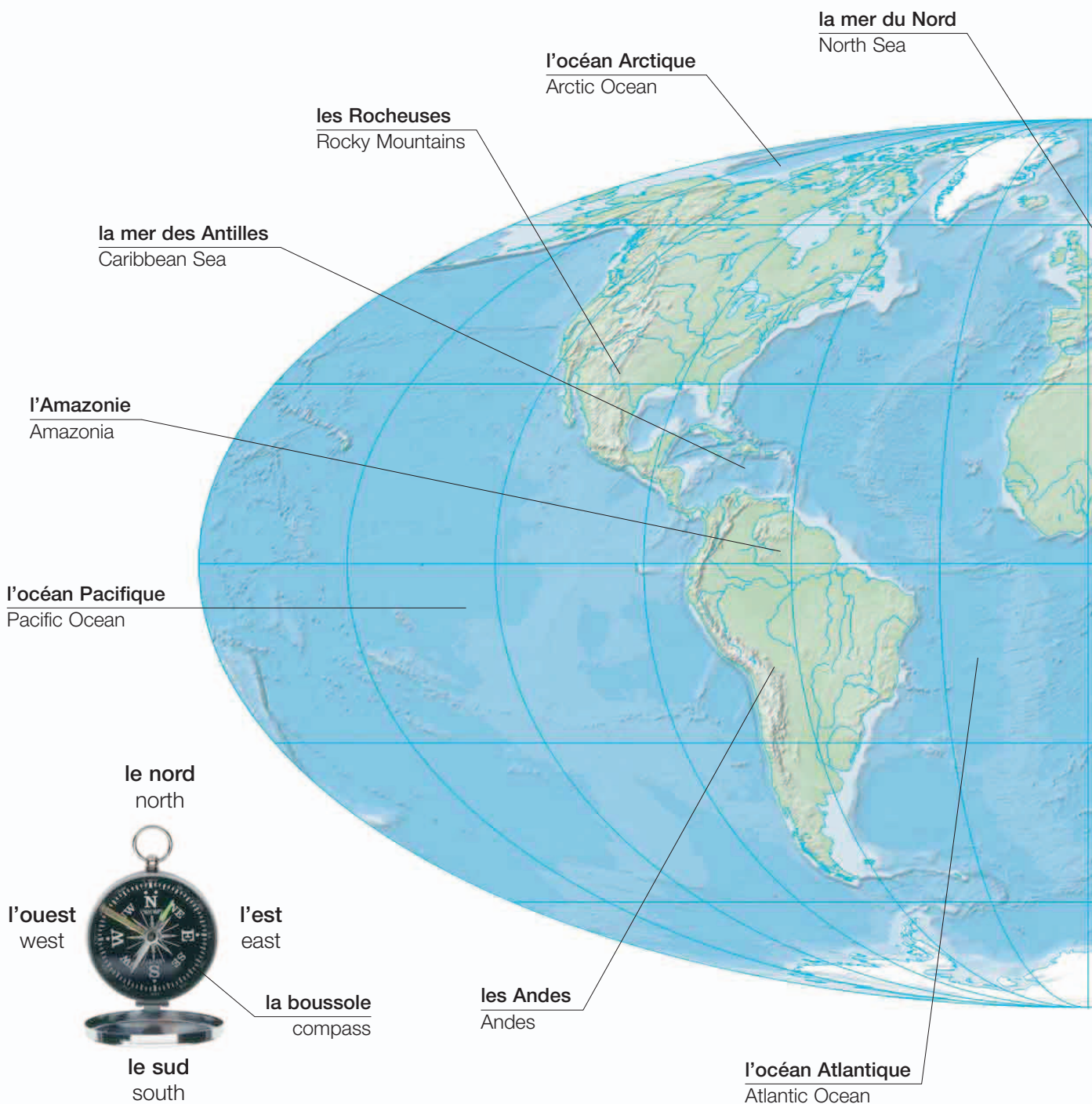

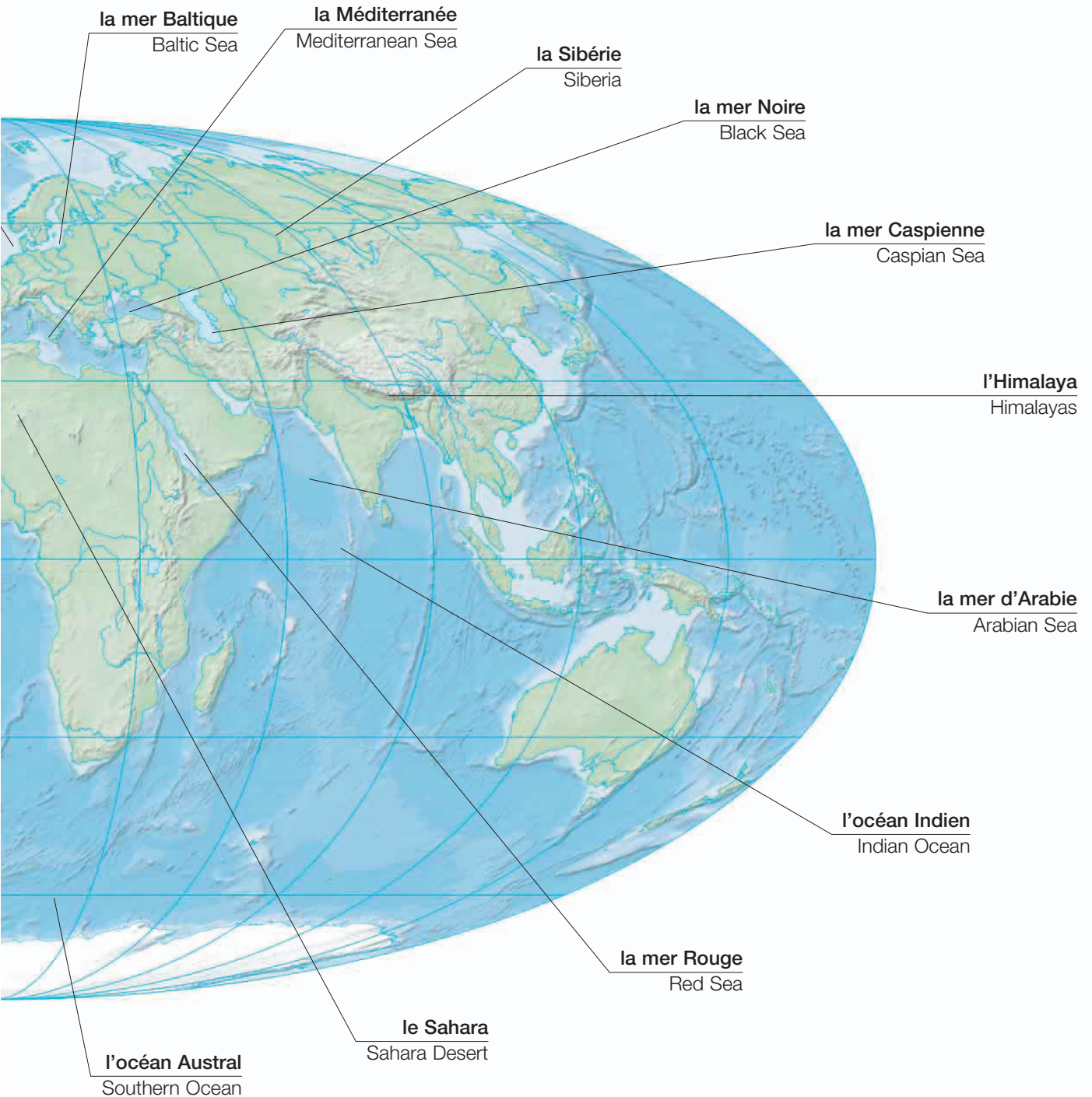

# l'Amérique du Nord et centrale • North and Central America



- 1 **l'Alaska** • Alaska
- 2 **le Canada** • Canada
- 3 **le Groenland** • Greenland
- 4 **les États-Unis d'Amérique**  
• United States of America
- 5 **le Mexique** • Mexico
- 6 **le Guatemala** • Guatemala
- 7 **(le) Bélize** • Belize
- 8 **Le Salvador** • El Salvador
- 9 **le Honduras** • Honduras
- 10 **le Nicaragua** • Nicaragua
- 11 **le Costa Rica** • Costa Rica
- 12 **le Panama** • Panama
- 13 **Cuba** • Cuba
- 14 **les Bahamas** • Bahamas
- 15 **la Jamaïque** • Jamaica
- 16 **Haïti** • Haiti
- 17 **la République dominicaine**  
• Dominican Republic
- 18 **la Porto Rico** • Puerto Rico
- 19 **la Barbade** • Barbados
- 20 **la Trinité-et-Tobago** • Trinidad and Tobago
- 21 **Saint-Kitts-et-Nevis** • St. Kitts and Nevis
- 22 **Antigua-et-Barbuda** • Antigua and Barbuda
- 23 **la Dominique** • Dominica
- 24 **Sainte-Lucie** • St. Lucia
- 25 **Saint-Vincent-et-les-Grenadines**  
• St. Vincent and The Grenadines
- 26 **la Grenade** • Grenada

# l'Amérique du Sud • South America



- 1 **le Venezuela** • Venezuela
- 2 **la Colombie** • Colombia
- 3 **l'Équateur** • Ecuador
- 4 **le Pérou** • Peru
- 5 **les îles Galapagos**
  - Galapagos Islands
- 6 **la Guyane** • Guyana
- 7 **le Surinam** • Suriname
- 8 **la Guyane française**
  - French Guiana
- 9 **le Brésil** • Brazil
- 10 **la Bolivie** • Bolivia
- 11 **le Chili** • Chile
- 12 **l'Argentine** • Argentina
- 13 **le Paraguay** • Paraguay
- 14 **l'Uruguay** • Uruguay
- 15 **les îles Malouines**
  - Falkland Islands

## vocabulaire • vocabulary

<b>le pays</b> country	<b>la province</b> province	<b>la zone</b> zone
<b>la nation</b> nation	<b>le territoire</b> territory	<b>le district</b> district
<b>l'État</b> state	<b>la colonie</b> colony	<b>la région</b> region
<b>le continent</b> continent	<b>la principauté</b> principality	<b>la capitale</b> capital

# I'Europe • Europe

- 1 **I'Irlande** • Ireland
- 2 **le Royaume-Uni** • United Kingdom
- 3 **le Portugal** • Portugal
- 4 **l'Espagne** • Spain
- 5 **les Baléares** • Balearic Islands
- 6 **l'Andorre** • Andorra
- 7 **la France** • France
- 8 **la Belgique** • Belgium
- 9 **les Pays-Bas** • Netherlands
- 10 **le Luxembourg**
  - Luxembourg
- 11 **l'Allemagne** • Germany
- 12 **le Danemark** • Denmark
- 13 **la Norvège** • Norway
- 14 **la Suède** • Sweden
- 15 **la Finlande** • Finland
- 16 **l'Estonie** • Estonia
- 17 **la Lettonie** • Latvia
- 18 **la Lituanie** • Lithuania
- 19 **Kaliningrad** • Kaliningrad
- 20 **la Pologne** • Poland
- 21 **la République tchèque**
  - Czech Republic
- 22 **l'Autriche** • Austria
- 23 **le Liechtenstein**
  - Liechtenstein
- 24 **la Suisse**
  - Switzerland
- 25 **l'Italie** • Italy
- 26 **Monaco**
  - Monaco
- 27 **la Corse**
  - Corsica
- 28 **la Sardaigne**
  - Sardinia
- 29 **le Saint-Marin** • San Marino
- 30 **la Cité du Vatican**
  - Vatican City
- 31 **la Sicile** • Sicily
- 32 **Malte** • Malta
- 33 **la Slovénie** • Slovenia
- 34 **la Croatie** • Croatia
- 35 **la Hongrie** • Hungary
- 36 **la Slovaquie** • Slovakia
- 37 **l'Ukraine** • Ukraine
- 38 **la Bélarus** • Belarus
- 39 **la Moldavie** • Moldova
- 40 **la Roumanie** • Romania
- 41 **la Serbie** • Serbia
- 42 **la Bosnie-Herzégovine**
  - Bosnia and Herzegovina
- 43 **l'Albanie** • Albania
- 44 **la Macédonie** • Macedonia
- 45 **la Bulgarie** • Bulgaria
- 46 **la Grèce** • Greece
- 47 **le Kosovo** • Kosovo
- 48 **Montenegro** • Montenegro
- 49 **l'Islande** • Iceland

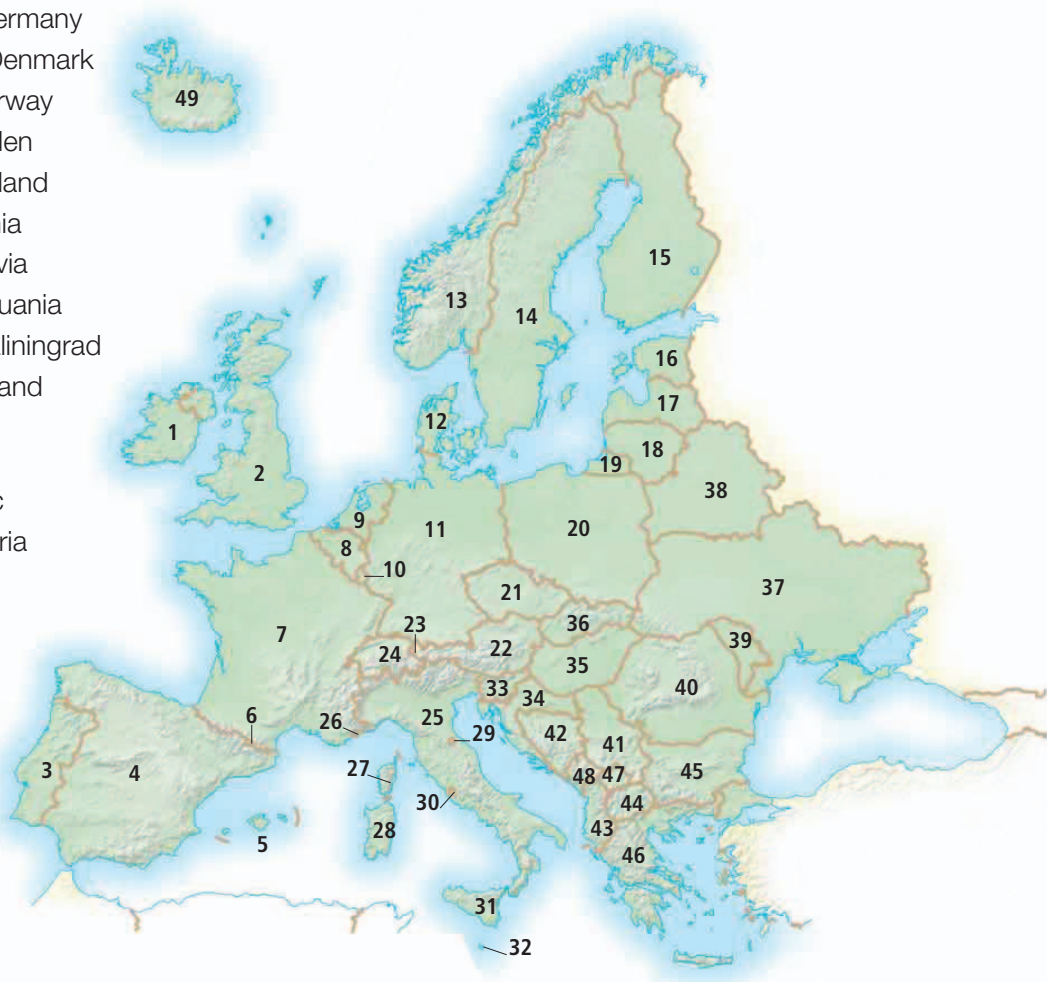

# l'Afrique • Africa

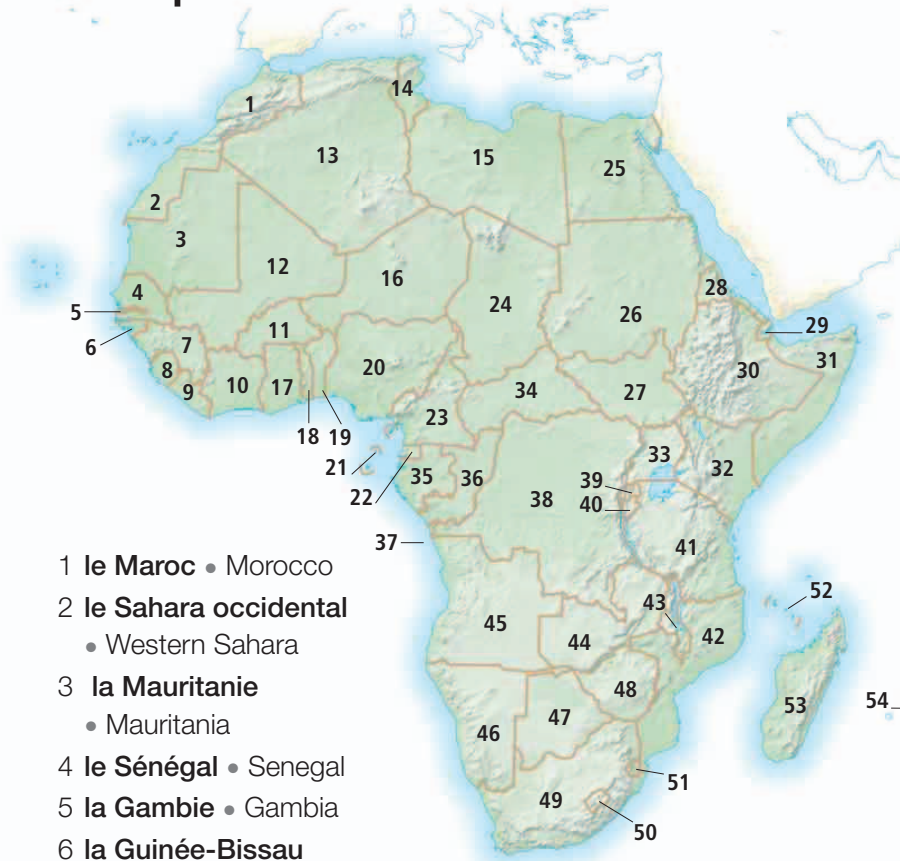

- 1 **le Maroc** • Morocco
- 2 **le Sahara occidental**  
• Western Sahara
- 3 **la Mauritanie**  
• Mauritania
- 4 **le Sénégal** • Senegal
- 5 **la Gambie** • Gambia
- 6 **la Guinée-Bissau**  
• Guinea-Bissau
- 7 **la Guinée** • Guinea
- 8 **la Sierra Leone**  
• Sierra Leone
- 9 **le Libéria** • Liberia
- 10 **la Côte d'Ivoire**  
• Ivory Coast
- 11 **le Burkina** • Burkina Faso
- 12 **le Mali** • Mali
- 13 **l'Algérie** • Algeria
- 14 **la Tunisie** • Tunisia
- 15 **la Libye** • Libya
- 16 **le Niger** • Niger
- 17 **le Ghana** • Ghana
- 18 **le Togo** • Togo
- 19 **le Bénin** • Benin

- 20 **le Nigéria** • Nigeria
- 21 **Sao Tomé-et-Principe**  
• São Tomé and Príncipe
- 22 **la Guinée équatoriale**  
• Equatorial Guinea
- 23 **le Cameroun** • Cameroon
- 24 **le Tchad** • Chad
- 25 **l'Égypte** • Egypt
- 26 **le Soudan** • Sudan
- 27 **le Soudan du Sud**  
• South Sudan
- 28 **l'Érythrée** • Eritrea
- 29 **Djibouti** • Djibouti
- 30 **l'Éthiopie** • Ethiopia
- 31 **la Somalie** • Somalia

- 32 **le Kenya** • Kenya
- 33 **l'Ouganda** • Uganda
- 34 **la République centrafricaine**  
• Central African Republic
- 35 **le Gabon** • Gabon
- 36 **le Congo** • Congo
- 37 **Cabinda** • Cabinda
- 38 **la République démocratique  
du Congo** • Democratic  
Republic of the Congo
- 39 **le Rwanda** • Rwanda
- 40 **le Burundi** • Burundi
- 41 **la Tanzanie** • Tanzania
- 42 **le Mozambique**  
• Mozambique
- 43 **le Malawi** • Malawi
- 44 **la Zambie** • Zambia
- 45 **l'Angola** • Angola
- 46 **la Namibie** • Namibia
- 47 **le Botswana** • Botswana
- 48 **le Zimbabwe** • Zimbabwe
- 49 **l'Afrique du Sud**  
• South Africa
- 50 **le Lesotho** • Lesotho
- 51 **le Swaziland** • Swaziland
- 52 **les Comores** • Comoros
- 53 **Madagascar** • Madagascar
- 54 **l'île Maurice** • Mauritius

# l'Asie • Asia

- 1 **la Turquie** • Turkey
- 2 **Chypre** • Cyprus
- 3 **la Fédération de Russie**
  - Russian Federation
- 4 **la Géorgie** • Georgia
- 5 **l'Arménie** • Armenia
- 6 **l'Azerbaïdjan** • Azerbaijan
- 7 **l'Iran** • Iran
- 8 **l'Irak** • Iraq
- 9 **la Syrie** • Syria
- 10 **le Liban** • Lebanon
- 11 **Israël** • Israel
- 12 **la Jordanie** • Jordan
- 13 **l'Arabie Saoudite**
  - Saudi Arabia
- 14 **le Koweït** • Kuwait
- 15 **Bahreïn** • Bahrain
- 16 **le Qatar** • Qatar
- 17 **les Émirats arabes unis**
  - United Arab Emirates
- 18 **l'Oman** • Oman
- 19 **le Yémen** • Yemen
- 20 **le Kazakhstan** • Kazakhstan
- 21 **l'Ouzbékistan** • Uzbekistan
- 22 **le Turkménistan** • Turkmenistan
- 23 **l'Afghanistan** • Afghanistan
- 24 **le Tadjikistan** • Tajikistan
- 25 **le Kirghizistan** • Kyrgyzstan
- 26 **le Pakistan** • Pakistan
- 27 **l'Inde** • India
- 28 **les Maldives** • Maldives
- 29 **Sri Lanka** • Sri Lanka
- 30 **la Chine** • China
- 31 **la Mongolie** • Mongolia
- 32 **la Corée du Nord** • North Korea
- 33 **la Corée du Sud** • South Korea
- 34 **le Japon** • Japan
- 35 **le Népal** • Nepal
- 36 **le Bhoutan** • Bhutan
- 37 **le Bangladesh** • Bangladesh
- 38 **la Birmanie (le Myanmar)**
  - Burma (Myanmar)
- 39 **la Thaïlande** • Thailand
- 40 **le Laos** • Laos
- 41 **le Vietnam** • Vietnam





## l'Australasie • Australasia



- 1 l'Australie • Australia
- 2 la Tasmanie • Tasmania
- 3 la Nouvelle-Zélande • New Zealand

- 42 le Cambodge • Cambodia
- 43 la Malaisie • Malaysia
- 44 Singapour • Singapore
- 45 l'Indonésie • Indonesia
- 46 le Brunei • Brunei
- 47 les Philippines • Philippines
- 48 le Timor oriental • East Timor
- 49 la Papouasie-Nouvelle-Guinée  
• Papua New Guinea
- 50 les îles Salomon • Solomon Islands
- 51 Vanuatu • Vanuatu
- 52 Fidji • Fiji

## particules et antonymes • particles and antonyms

<b>à</b> to	<b>de</b> from	<b>pour</b> for	<b>vers</b> toward
<b>au-dessus de</b> over	<b>sous</b> under	<b>le long de</b> along	<b>à travers</b> across
<b>devant</b> in front of	<b>derrière</b> behind	<b>avec</b> with	<b>sans</b> without
<b>sur</b> onto	<b>dans</b> into	<b>avant</b> before	<b>après</b> after
<b>dans</b> in	<b>dehors</b> out	<b>avant</b> by	<b>jusqu'à</b> until
<b>au-dessus de</b> above	<b>au-dessous de</b> below	<b>tôt</b> early	<b>tard</b> late
<b>à l'intérieur de</b> inside	<b>à l'extérieur de</b> outside	<b>maintenant</b> now	<b>plus tard</b> later
<b>en haut</b> up	<b>en bas</b> down	<b>toujours</b> always	<b>jamais</b> never
<b>à</b> at	<b>au-delà de</b> beyond	<b>souvent</b> often	<b>rarement</b> rarely
<b>à travers</b> through	<b>autour de</b> around	<b>hier</b> yesterday	<b>demain</b> tomorrow
<b>sur</b> on top of	<b>à côté de</b> beside	<b>premier</b> first	<b>dernier</b> last
<b>entre</b> between	<b>en face de</b> opposite	<b>chaque</b> every	<b>quelque</b> some
<b>près de</b> near	<b>loin de</b> far	<b>vers</b> about	<b>exactement</b> exactly
<b>ici</b> here	<b>là</b> there	<b>un peu</b> a little	<b>beaucoup</b> a lot

**grand**  
large**petit**  
small**chaud**  
hot**froid**  
cold**large**  
wide**étroit**  
narrow**ouvert**  
open**fermé**  
closed**grand**  
tall**court**  
short**plein**  
full**vide**  
empty**haut**  
high**bas**  
low**neuf**  
new**vieux**  
old**épais**  
thick**mince**  
thin**clair**  
light**foncé**  
dark**léger**  
light**lourd**  
heavy**facile**  
easy**difficile**  
difficult**dur**  
hard**mou**  
soft**libre**  
free**occupé**  
occupied**humide**  
wet**sec**  
dry**fort**  
strong**faible**  
weak**bon**  
good**mauvais**  
bad**gros**  
fat**mince**  
thin**rapide**  
fast**lent**  
slow**jeune**  
young**vieux**  
old**juste**  
correct**faux**  
wrong**mieux**  
better**pire**  
worse**propre**  
clean**sale**  
dirty**noir**  
black**blanc**  
white**beau**  
beautiful**laid**  
ugly**intéressant**  
interesting**ennuyeux**  
boring**cher**  
expensive**bon marché**  
cheap**malade**  
sick**bien**  
well**silencieux**  
quiet**bruyant**  
noisy**le début**  
beginning**la fin**  
end

# phrases utiles • useful phrases

## phrases essentielles

• essential phrases

### Oui

Yes

### Non

No

### Peut-être

Maybe

### S'il vous plaît

Please

### Merci

Thank you

### De rien

You're welcome

### Pardon

Excuse me

### Je suis désolé

I'm sorry

### Ne... pas

Don't

### D'accord

OK

### Très bien

That's fine

### C'est juste

That's correct

### C'est faux

That's wrong

## salutations

• greetings

### Bonjour

Hello

### Au revoir

Goodbye

### Bonjour

Good morning

### Bonjour

Good afternoon

### Bonsoir

Good evening

### Bonne nuit

Good night

### Comment allez-vous?

How are you?

### Je m'appelle...

My name is...

### Vous vous appelez comment?

What is your name?

### Il/Elle s'appelle comment?

What is his/her name?

### Je vous présente...

May I introduce...

### C'est...

This is...

### Enchanté

Pleased to meet you

## À tout à l'heure

See you later

## panneaux • signs

### Office de tourisme

Tourist information

### Entrée

Entrance

### Sortie

Exit

### Sortie de secours

Emergency exit

### Poussez

Push

### Danger

Danger

### Défense de fumer

No smoking

### En panne

Out of order

### Heures d'ouverture

Opening times

### Entrée gratuite

Free admission

### Journée continue

Open all day

### Prix réduit

Reduced price

### Soldes

Sale

## Frappez avant d'entrer

Knock before entering

## Défense de marcher sur la pelouse

Keep off the grass

## assistance • help

### Pouvez-vous m'aider?

Can you help me?

### Je ne comprends pas

I don't understand

### Je ne sais pas

I don't know

### Vous parlez anglais, français...?

Do you speak English, French...?

### Je parle anglais, espagnol...

I speak English, Spanish...

### Parlez moins vite, s'il vous plaît

Please speak more slowly

### Écrivez-le pour moi, s'il vous plaît

Please write it down for me

### J'ai perdu...

I have lost...

**directions**

- directions

**Je me suis perdu**

I am lost

**Où est le/la...?**

Where is the...?

**Où est le/la...le/la plus proche?**

Where is the nearest...?

**Où sont les toilettes?**

Where are the restrooms?

**Pour aller à...?**

How do I get to...?

**À droite**

To the right

**À gauche**

To the left

**Tout droit**

Straight ahead

**C'est loin...?**

How far is...?

**les panneaux routiers**

- road signs

**Toutes directions**

All directions

**Prudence**

Caution

**Entrée interdite**

No entry

**Ralentir**

Slow down

**Déviation**

Detour

**Serrez à droite**

Keep right

**Autoroute**

Freeway

**Stationnement interdit**

No parking

**Passage interdit**

No through road

**Sens unique**

One-way street

**Autres directions**

Other directions

**Riverains autorisés**

Residents only

**Travaux**

Road construction

**Virage dangereux**

Dangerous bend

**logement •  
accommodation****J'ai réservé une chambre**

I have a reservation

**Où est la salle à manger?**

Where is the dining room?

**Le numéro de ma chambre est le ...**

My room number is ...

**Le petit déjeuner est à quelle heure?**

What time is breakfast?

**Je serai de retour à ... heures**

I'll be back at ... o'clock

**Je pars demain**

I'm leaving tomorrow

**nourriture et boissons**

- eating and drinking

**À la vôtre!**

Cheers!

**C'est délicieux/terrible**

It's delicious/awful

**Je ne bois/fume pas**

I don't drink/smoke

**Je ne mange pas de la viande**

I don't eat meat

**Je n'en veux plus, merci**

No more for me, thank you

**Encore un peu, s'il vous plaît.**

May I have some more?

**L'addition, s'il vous plaît.**

May we have the bill/check?

**Je voudrais un reçu.**

Can I have a receipt?

**Partie non-fumeurs**

No-smoking area

**la santé**

- health

**Je ne me sens pas bien**

I don't feel well

**J'ai envie de vomir**

I feel sick

**Pouvez-vous me donner le numéro de téléphone du docteur le plus proche?**

What is the telephone number of the nearest doctor?

**J'ai mal ici**

It hurts here

**J'ai de la fièvre**

I have a fever

**Je suis enceinte de ...mois**

I'm ... months pregnant

**J'ai besoin d'une ordonnance pour ...**

I need a prescription for ...

**Je prends habituellement ...**

I normally take ...

**Je suis allergique à ...**

I'm allergic to ...

## index français • French index

- A**  
à 320  
à armature 35  
à côté de 320  
à deux portes 200  
à droite 260  
à emporter 154  
à feuilles caduques 86  
à feuilles persistantes 86  
à gauche 260  
à genou 34  
à grains longs 130  
à grains ronds 130  
à impériale 260  
à l'extérieur de 320  
à l'heure 305  
à l'intérieur de 320  
à la carte 152  
à l'huile 143  
à quatre portes 200  
à sens unique 194  
à travers 320  
à trois portes 200  
abats *m* 118  
abdominaux *m* 16  
abeille *f* 295  
abribus *m* 197  
abricot *m* 126  
acacia *m* 110  
accélérateur *m* 200, 204  
accès aux handicapés *m* 197  
accessoires *m* 36, 38  
accessoires de toilette *m* 41  
accident *m* 46  
accident de voiture *m* 203  
accompagnement *m* 153  
accotement stabilisé *m* 194  
accouchement *m* 52  
accouchement assisté *m* 53  
accouder *m* 200, 210  
accusation *f* 94, 180  
accusé *m* 180, 181  
acquitté 181  
acrylique *m* 274  
acte de naissance *m* 26  
acte judiciaire *m* 180  
acteur *m* 254  
acteurs *m* 179  
action *f* 97  
actions *f* 97, 233, 227, 229, 237  
activités *f* 77, 162, 183, 245, 263  
activités de plein air *f* 262  
actrice *f* 254  
acupuncture *f* 55  
acupression *f* 55  
addition *f* 152  
ajouter 165  
admis 48  
adolescente *f* 23  
adresse e-mail *f* 177  
adulte *m* 23  
adversaire *f* 236  
adzukis *m* 131  
aéroboxe *m* 251  
aéroglysseur *m* 215  
aéroport *m* 212  
affaires *f* 175  
affiche *f* 255  
Afghanistan 318  
Afrique 317  
Afrique du Sud 317  
after-shave *m* 73  
agate *f* 289  
agence de voyage *f* 114  
agenda *m* 173, 175  
agenda électronique *m* 175  
agent de conservation *m* 83  
agent de la bourse *m* 97  
agent de la circulation *m* 195  
agent de voyage *m* 190  
agent immobilier *m* 115, 189  
aggloméré *m* 79  
agitateur *m* 150  
agneau *m* 118, 185  
agrafe *f* 276  
agrafes *f* 173  
agrafeuse *f* 173  
agrandir 172  
agrandissement *m* 58, 271  
agression *f* 94  
agriculteur *m* 182  
agrumes *m* 126  
aigle *m* 292  
aiglefin *m* 120  
aigre 127  
aigue-marine *f* 288  
aiguille *f* 109, 276  
aiguille à tricoter *f* 277  
aiguiseur *m* 68  
aikido *m* 236  
ail *m* 125, 132  
aile *f* 60, 119, 210, 293  
aileron *m* 210  
ailes de raie *f* 120  
aimant *m* 167  
aine *f* 12  
airbag *m* 201  
aire *f* 165  
aire de stationnement *f* 199, 212  
aisselle *f* 13  
ajusté 35  
alarme *f* 58  
Alaska 314  
Albanie 316  
album de photos *m* 271  
alésoir *m* 80  
Algérie 317  
alimentation *f* 105  
aliments en bouteille *m* 134  
allaitement *m* 53  
allant au four 69  
allée *f* 58, 85, 106, 254  
Allemagne 316  
allergie *f* 44  
alligator *m* 293  
allonge *f* 118  
allumage *m* 200  
allume-feu *m* 266  
allumer la télévision 269  
allumer un feu 266  
alternateur *m* 203  
altitude *f* 211  
alto *m* 256  
aluminium *m* 289  
amande *f* 129  
amandes *f* 151  
amarres *f* 217  
Amazonie *f* 312  
amer 124  
Amérique centrale 314  
Amérique du Nord 314  
améthyste *f* 288  
ameublement *m* 105  
ami *m* 24  
amniocentèse *f* 52  
amorcer *f* 244  
amorcer 245  
amorti *m* 230  
ampère *m* 60  
amphibiens *m* 294  
amplificateur *m* 268  
ampoule *f* 46, 60  
ampoule basse consommation *f* 60  
amuse-gueule *m* 151  
an *m* 306  
analgésique *m* 109  
analgésiques *m* 47  
analogique 179  
analyse *f* 49  
analyse de sang *f* 48  
ananas *m* 128  
ancres *f* 214, 240  
Andes *f* 312  
Andorre 316  
âne *m* 185  
anesthésiste *m* 48  
aneth *f* 133  
angle *m* 164  
Angola 317  
anguille *f* 294  
animalerie *f* 115  
animaux *m* 292, 294  
anis *m* 133  
anneau *m* 226  
anneaux *m* 89, 235  
anniversaire *m* 27  
anniversaire de mariage *m* 26  
annuel 86, 307  
annulaire *m* 15  
anorak *m* 31, 33  
anse *f* 106  
antenne *f* 295  
antenne parabolique *f* 269  
antenne radio *f* 214  
anti-adhérent 69  
antigel *m* 199, 203  
Antigua-et-Barbuda 314  
anti-inflammatoire *m* 109  
antrides 41  
antiseptique *m* 47  
antivol *m* 207  
août *m* 306  
apéritif *m* 153  
appareil de chauffage *m* 60  
appareil de gym *m* 250  
appareil dentaire *m* 50  
appareil instantané *m* 270  
appareil jetable *m* 270  
appareil numérique *m* 270  
appareil photo *m* 260  
appareils électriques *m* 105  
appareils ménagers *m* 66  
apparence *f* 30  
appartement *m* 59  
appât *m* 244  
appel *m* 181  
appendice *m* 18  
applaudir 255  
appli *m* 99  
application *f* 176  
applique *f* 62  
apprendre 163  
apprêt *m* 83  
après 320  
après-demain 307  
après-midi *f* 305  
après-shampooing *m* 38  
après-soleil *m* 108  
aquarelle *f* 274  
Arabie Saoudite 318  
araignée *f* 295  
arbitre *m* 222, 225, 226, 229, 230  
arbre *m* 86, 296  
arbre de transmission *m* 202  
arbuste à fleurs *m* 87  
arc *m* 164, 249, 300  
arceau *m* 85  
arc-en-ciel *m* 287  
architecte *m* 190  
architecture *f* 300  
architrave *f* 301  
ardoise *f* 288  
arène *f* 243  
arête *f* 121  
argent *m* 97, 235, 289  
anse *f* 106  
Argentine 315  
argile *f* 85, 275  
arithmétique *f* 165  
Arménie 318  
armoire *f* 70  
armoire à pharmacie *f* 72  
armoire encastrée *f* 71  
aromathérapie *f* 55  
arrestation *f* 94  
arrêt *m* 269  
arrêt de bus *m* 197, 299  
arrêt interdit 195  
arrière *m* 240  
arrivée *f* 61  
arrivées *f* 213  
arrosage *m* 89  
arroser 90, 183  
arroseeur *m* 89  
art *m* 162  
art déco 301  
art nouveau 301  
artère *f* 19  
artichaut *m* 124  
articles de sport *m* 105  
articles de toilette *m* 107  
articles pour bébés *m* 107  
articulation *f* 17  
articulation du doigt *f* 15  
artiste peintre *f* 274  
arts et métiers *m* 274, 276  
arts martiaux *m* 237  
as *m* 230, 273  
ascenseur *m* 59, 100, 104  
Asie 318  
asperge *f* 124  
asperger 91  
aspirateur *m* 77, 188  
assaisonné 159  
assiette *f* 65  
assiette à dessert *f* 65  
assiette à soupe *f* 65  
assiette plate *f* 65  
assignation *f* 180  
assistant *m* 169  
assistante *f* 24  
assister à 174  
associée *f* 24  
assouplisseur *m* 76  
astéroïde *m* 280

- asthme *m* 44  
 astigmatisme *m* 51  
 astronaute *m* 281  
 astronomie *f* 281  
 atelier *m* 78  
 athlète *m* 234  
 athlétisme *m* 234  
 atmosphère *f* 282, 286  
 atrium *m* 104  
 attaches *f* 89  
 attaque *f* 44, 220  
 attelle *f* 47  
 attenante 58  
 attendrisseur *m* 69  
 atterrir 211  
 attraction touristique *f* 260  
 attractions *f* 261  
 attraper 225, 227, 229, 220, 245  
 au carré 39  
 au revoir 322  
 au sirop 159  
 aube *f* 305  
 aubergine *f* 125  
 auburn 39  
 au-delà de 320  
 au-dessous de 320  
 au-dessus de 320  
 auge *f* 183  
 aujourd'hui 306  
 auriculaire *m* 15  
 aurore *f* 286  
 Australasie 319  
 Australie 319  
 autobronzant *m* 41  
 autodéfense *f* 237  
 automatique 200  
 automne *m* 31, 307  
 autoneige *m* 247  
 autopont *m* 194  
 autoroute *f* 194  
 autour de 320  
 autres arts *m* 275  
 autres bateaux *m* 215  
 autres magasins *m* 114  
 autres sports *m* 248  
 Autriche 316  
 autruche *f* 292  
 aux pépites de chocolats 141  
 avalanche *f* 247  
 avance rapide *f* 269  
 avant 320  
 avant *m* 240  
 avant *m* 222  
 avantage *m* 230  
 avant-bras *m* 12  
 avant-hier 307  
 avant-toit *m* 58  
 avec 320  
 avec plomb 199  
 avenue *f* 299  
 averse *f* 286  
 avertisseur d'incendie *m* 95
- avion *m* 210  
 avion de ligne *m* 210, 212  
 avion léger *m* 211  
 avocat *m* 128, 180, 190  
 avoine *f* 130  
 avoir faim 64  
 avoir un bébé 26  
 avril *m* 306  
 Azerbaïdjan 318
- B**  
 babeurre *m* 137  
 bac à légumes *m* 67  
 bac à peinture *m* 83  
 bac à sable *m* 263  
 bacon *m* 118, 157  
 badge *m* 94, 189  
 badminton *m* 231  
 baffle *m* 268  
 bagages *m* 100, 198, 213  
 bagages à main *m* 211, 213  
 bague *f* 36  
 baguette *f* 138, 256  
 Bahamas 314  
 baie *f* 296  
 baignoire *f* 72  
 baignoire en plastique *f* 74  
 bâiller 25  
 bain moussant *m* 73  
 balai *m* 77  
 balai à gazon *m* 88  
 balai laveur *m* 77  
 balance *f* 45, 69, 98, 118, 166, 212, 310  
 balance à ressort *f* 166  
 balancier *m* 276  
 balançoire *f* 263  
 balayer 77  
 balayette *f* 77  
 balcon *m* 59, 254  
 Baléares 316  
 baleine *f* 290  
 balle *f* 75, 130, 184, 224, 228, 230  
 balle de criquet *f* 225  
 balle de golf *f* 233  
 ballerine *f* 37  
 ballet *m* 255  
 ballon *m* 221, 220, 222, 226  
 ballon de plage *m* 265  
 ballon lancé *m* 226  
 bambou *m* 86, 122  
 banane *f* 128  
 banc *m* 250, 262  
 banc à pique-nique *m* 266  
 banc de touche *m* 229  
 banc des jurés *m* 180  
 bandage *m* 47  
 bande de roulement *f* 207
- bande dessinée *f* 112  
 bande fluorescente *f* 205  
 bande sonore *f* 255  
 Bangladesh 318  
 banlieue *f* 299  
 banque *f* 96  
 baptême *m* 26  
 bar *m* 120, 150, 152  
 Barbade 314  
 barbecue *m* 267  
 barbillon *m* 244  
 barman *m* 150, 191  
 bar-mitsvah *f* 26  
 baroque 301  
 barque *f* 214  
 barrage *m* 300  
 barre *f* 207, 235, 240, 250  
 barre à poids *f* 251  
 barre d'outils *f* 177  
 barre de défilement *f* 177  
 barre de menus *f* 177  
 barre de mesure *f* 256  
 barre fixe *f* 235  
 barre transversale *f* 222  
 barreaux *m* 74  
 barres asymétriques *f* 235  
 barres parallèles *f* 235  
 barrière *f* 182  
 barrière d'escalier *f* 75  
 barrière de sécurité *f* 246  
 bas 321  
 bas *m* 35  
 basalte *m* 288  
 bascule *f* 263  
 base *f* 99, 164, 229  
 base du batteur *f* 228  
 baseball *m* 228  
 basilic *m* 133  
 basket *m* 226  
 basket *f* 37  
 baskets *m* 251  
 baskets *f* 31  
 bassin *m* 17, 85  
 bassin *m* 257  
 bateau de pêche *m* 217  
 bâtiments *m* 299  
 bâtir 277  
 bâton *m* 235  
 bâton de ski *m* 246  
 bâtons *m* 133  
 batter 229  
 batterie *f* 202, 258  
 batteur *m* 225, 228  
 battre 67, 273  
 battre un record 234  
 bavoir *m* 30, 50  
 beat *m* 259  
 beau-fils *m* 23  
 beau-frère *m* 23
- beau-père *m* 23  
 beauté *f* 40, 105  
 bébé *m* 23, 30  
 bébé-phoque *m* 290  
 bec *m* 293  
 bec Bunsen *m* 166  
 bécarre *m* 256  
 bêche *f* 88  
 bécher *m* 167  
 bécher 90  
 beignets de poulet *m* 155  
 Bélarus 316  
 Belgique 316  
 Bélize 314  
 belle-fille *f* 22, 23  
 belle-mère *f* 23  
 belle-sœur *f* 23  
 bémol *m* 256  
 Bénin 317  
 béquille *f* 205, 207  
 berline *f* 199  
 berline à hayon *f* 199  
 bermuda *m* 30  
 bétail *m* 182  
 bétonnière *f* 186  
 bette *f* 123  
 betterave *f* 125  
 beurre *m* 137, 156  
 beurre de cacahouètes *m* 135  
 Bhoutan 318  
 biathlon *m* 247  
 biberon *m* 75  
 bibliothécaire *m* 190  
 bibliothécaire *f* 168  
 bibliothèque *f* 63, 168, 299  
 biceps *m* 16  
 bicyclette *f* 206  
 bidet *m* 72  
 bière *f* 145, 151  
 bière anglaise *f* 145  
 bière brune *f* 145  
 bifocal 51  
 bifteck d'aloyau *m* 119  
 bijouterie *f* 114  
 bijoutier *m* 188  
 bijoux *m* 36  
 bikini *m* 264  
 billard *m* 249  
 billard américain *m* 249  
 billet *m* 97, 209, 213  
 billets de loterie *m* 112  
 biologie *f* 162  
 biologique 91, 122  
 biplan *m* 211  
 Birmanie 318  
 bis *m* 255  
 bisannuel 86  
 biscuit *m* 113  
 biscuit scandinave *m* 139, 156  
 biscuits *m* 141  
 blanc 39, 145, 272, 274  
 blanc *m* 119
- blanc d'œuf *m* 137  
 blazer *m* 33  
 blé *m* 130, 184  
 blé écrasé *m* 130  
 blessure *f* 46  
 bleu 274  
 bleu *m* 136  
 bleu *m* 82  
 bloc de béton *m* 187  
 blocage *m* 237  
 bloc-note 173  
 blond 39  
 bloquer 227  
 blues *m* 259  
 bobine *f* 276  
 bobine de fil *f* 276  
 bobsleigh *m* 247  
 bocal scellé *m* 135  
 bœuf *m* 118  
 bois *m* 79, 187, 233, 257, 275, 285  
 bois dur *m* 79  
 bois tendre *m* 79  
 boisson en boîte *f* 154  
 boisson maltée *f* 144  
 boisson non alcoolisée *f* 154  
 boissons *f* 107, 144, 156  
 boissons alcoolisées *f* 145  
 boissons chaudes *f* 144  
 boissons non alcoolisées *f* 144  
 boîte *f* 145, 311  
 boîte à bijoux *f* 36  
 boîte à déchets recyclables *f* 61  
 boîte à fusibles *f* 60  
 boîte à onglets *f* 81  
 boîte à outils *f* 80  
 boîte aux lettres *f* 58, 99  
 boîte d'équipement *f* 244  
 boîte de chocolats *f* 113  
 boîte de kleenex *f* 70  
 boîte de réception *f* 177  
 boîte de tri *f* 61  
 boîte de vitesses *f* 202, 204  
 boîte d'outils *f* 207  
 bol *m* 65  
 bol du mixeur *m* 66  
 Bolivie 315  
 bollard *m* 214  
 bombardier *m* 211  
 bombe *f* 242, 311  
 bôme *m* 240  
 bon 321  
 bonbon à la menthe *m* 113  
 bonbon au fruit *m* 113  
 bonbons *m* 113  
 bonbons assortis *m* 113  
 bonde *f* 72  
 bongos *m* 257

- bonjour 322  
 bonne nuit 322  
 bonnet de natation *m*  
 238  
 bonsoir 322  
 bord du trottoir *m* 298  
 bordure de plantes  
 herbacées *f* 85  
 bordure de plantes  
 mixtes *f* 85  
 borne *f* 298  
 borne d'incendie *f* 95  
 Bosnie-Herzégovine 316  
 bosse *f* 291  
 Botswana 317  
 botte *f* 37, 111, 242  
 botter 221, 223  
 bottes *f* 89  
 bottes de caoutchouc *f*  
 31  
 bottes de pêche *f* 244  
 bouche *f* 14  
 bouche d'égout *f* 299  
 boucher *m* 118, 188  
 boucherie *f* 114  
 bouchon *m* 134, 166  
 bouchon d'objectif *m* 270  
 boucle *f* 36  
 boucle d'oreille *f* 36  
 boudin *m* 157  
 boudoirs *m* 141  
 bouée *f* 217, 265  
 bouée de sauvetage *f*  
 240  
 bougie *f* 203  
 bougies d'anniversaire *f*  
 141  
 bouillir 67  
 bouilloire électrique *f* 66  
 bouillon *m* 158  
 bouillotte *f* 70  
 boulanger *m* 139  
 boulangerie *f* 107, 114,  
 138  
 boule *f* 149  
 boule de bowling *f* 249  
 bouleau *m* 296  
 boules de coton *f* 41  
 boulettes de viande *f*  
 158  
 bouquet *m* 35, 111  
 bouquet garni *m* 132  
 bourgeon *m* 111  
 bourriche *f* 244  
 bourse *f* 97, 169  
 boussole *f* 312  
 bouteille *f* 61, 135, 166,  
 311  
 bouteille d'eau *f* 206,  
 267  
 bouteille d'air *f* 239  
 boutique *f* 115  
 boutique d'art *f* 115  
 boutique de cadeaux *f*  
 114  
 boutique hors
- taxes *f* 213  
 bouton *m* 31, 32, 297  
 bouton d'appel *m* 48  
 bouton d'arrêt *m* 197  
 bouton de manchette *m*  
 36  
 bouton de mise  
 au point *m* 167  
 bouton de porte *m* 59  
 boutonnière *f* 32  
 bouton-pression *m* 30  
 bowling *m* 249  
 box *m* 269  
 boxe *f* 236  
 boxe thaïlandaise *f* 236  
 bracelet *m* 36  
 bracelet d'identité *m* 53  
 brancard *m* 94  
 branche *f* 296  
 brandy *m* 145  
 bras *m* 13, 88  
 brassard *m* 45  
 brasse *f* 239  
 brassière *f* 238  
 break *m* 199  
 Brésil 315  
 bretelle *f* 35, 37  
 bretelle d'accès *f* 194  
 bretelle de sortie *f* 194  
 bride *f* 241, 242  
 bridge *m* 273  
 brie *m* 142  
 brillant 83  
 brillant à lèvres *m* 40  
 brillant 271  
 brindille *f* 296  
 brioche *f* 157  
 brique *f* 136, 187, 311  
 briquet *m* 112  
 brise-bise *m* 63  
 broche *f* 36, 60, 68  
 brochure *f* 175  
 brochure de vacances *f*  
 212  
 brocoli *m* 123  
 broderie *f* 277  
 bronzage *m* 41  
 bronze *m* 235  
 brosse *f* 38, 72, 83  
 brosse à dents *f* 72  
 brosse à encoller *f* 82  
 brosse à sourcils *f* 40  
 brosse à tapisser *f* 82  
 brosse pour le dos *f* 73  
 brosser 38, 50  
 brouette *f* 88  
 brouillard *m* 287  
 broyeur d'ordures *m* 61  
 brûleur *m* 67  
 brûleur à gaz *m* 61  
 brûlure *f* 46  
 brume *f* 287  
 Brunei 319  
 bruyère *f* 297  
 buanderie *f* 76  
 buffet *m* 152
- buffet du petit déjeuner *m*  
 156  
 buggy *m* 232  
 bulbe *m* 86  
 Bulgarie 316  
 bunker *m* 232  
 bureau 172  
 bureau *m* 24, 63, 174,  
 177  
 bureau de change *m* 97  
 bureau des douanes *m*  
 216  
 bureau du chef *m* 266  
 burin *m* 81, 275  
 Burkina 317  
 Burundi 317  
 bus *m* 196  
 bus à deux étages *m*  
 196  
 bus de touristes *m* 197  
 bus scolaire *m* 196  
 bus touristique *m* 260  
 but *m* 221, 223, 224  
 bytes *m* 176
- C**  
 cabane *f* 84  
 cabine d'essayage *f* 104  
 Cabinda 317  
 cabine *f* 95, 210, 214  
 cabine de plage *f* 264  
 cabine du conducteur *f*  
 208  
 cabine téléphonique *f* 99  
 cabinet *m* 45, 180  
 câble *m* 79, 207  
 câble électrique *m* 176,  
 209  
 cabriolet *f* 235  
 cabriolet sport *m* 198  
 cacahouète *f* 129  
 cacahouètes *f* 151  
 cacao *m* 156  
 cacatoès *m* 293  
 cachet 173  
 cachets  
 antinaupathiques *m*  
 109  
 cactus *m* 87  
 caddie *m* 106, 208, 233  
 cadeau *m* 27  
 cadre *m* 62, 174, 206,  
 230, 267  
 cadre de photo *m* 271  
 cafard *m* 295  
 café *m* 144, 148, 153,  
 156, 184, 262  
 café filtre *m* 148  
 café glacé *m* 148  
 café moulu *m* 144  
 cafetière *f* 65  
 cage à poules *f* 263  
 cage thoracique *f* 17  
 cahier *m* 163  
 caille *f* 119  
 caisse *f* 106, 150, 255
- caisse claire *f* 257  
 caissier *m* 96, 106  
 cake *m* 140  
 calamar *m* 121  
 calcaire *m* 288  
 calcite *f* 289  
 calcium *m* 109  
 calculatrice *f* 165  
 cale *f* 215, 233  
 cale sèche *f* 217  
 caleçon *m* 33  
 calendrier *m* 306  
 cale-pied *m* 207  
 calice *m* 297  
 calmar *m* 295  
 Cambodge 318  
 cambriolage *m* 94  
 cambure *f* 15  
 camembert *m* 142  
 caméra *f* 178  
 cameraman *m* 178  
 Cameroun 317  
 caméscope *m* 260, 269  
 camion *m* 194  
 camionneur *m* 190  
 camisole *f* 35  
 camomille *f* 149  
 Campari *m* 145  
 camper 266  
 camping *m* 266  
 camping-car *m* 266  
 campus *m* 168  
 Canada 314  
 canapé *m* 62, 155  
 canapé-lit *m* 63  
 canard *m* 119, 185  
 canari *m* 292  
 caneton *m* 185  
 canine *f* 50  
 caniveau *m* 299  
 canne *f* 91  
 canne à pêche *f* 244  
 canne à sucre *f* 184  
 canneberge *f* 127  
 cannelle *f* 133  
 Cannes *f* 89  
 canoë *m* 214, 241  
 canot pneumatique *m*  
 215  
 canot de sauvetage *m*  
 214  
 capacité *f* 311  
 cape cervicale *f* 21  
 capitaine *m* 214  
 capitaine de port *m* 217  
 capitale *f* 315  
 capoeira *m* 237  
 capot *m* 198  
 capote *f* 75  
 cappuccino *m* 148  
 câpres *f* 143  
 capuche *f* 31  
 car *m* 196  
 caractéristiques *f* 282  
 carambole *f* 128  
 caramel *m* 113
- carapace *f* 293  
 caravane *f* 266  
 cardamome *f* 132  
 cardigan *m* 32  
 cardiologie *f* 49  
 cardio-vasculaire 19  
 cargaison *f* 216  
 cargo *m* 215  
 carie *f* 50  
 carnaval *m* 27  
 carnet 172  
 carnet à croquis *m* 275  
 carnet de chèques *m* 96  
 carotte *f* 124  
 carpe koi *f* 294  
 carquois *m* 249  
 carre *f* 246  
 carré *m* 164  
 carreau *m* 273  
 carrefour *m* 194, 298  
 carreler 82  
 carrosserie *f* 202  
 cartable *m* 162  
 carte *f* 27, 153, 154  
 carte bancaire *f* 96  
 carte d'embarquement *f*  
 213  
 carte de crédit *f* 96  
 carte de lecteur *f* 168  
 carte des vins *f* 152  
 carte du monde *f* 312  
 carte postale *f* 112  
 cartilage *m* 17  
 carton *m* 275  
 carton jaune *m* 223  
 carton rouge *m* 223  
 cascade *f* 285  
 case *f* 272  
 casier *m* 100  
 casier à bagages *m* 210  
 casier judiciaire *m* 181  
 casiers *m* 239  
 casino *m* 261  
 casque *m* 95, 204, 206,  
 220, 224, 228  
 casque de sécurité *m*  
 186  
 casquette *f* 36  
 casserole *f* 69  
 cassette *f* 269  
 cassis *m* 127  
 catamaran *m* 215  
 cataphote *m* 207  
 cataracte *f* 51  
 cathédrale *f* 300  
 cathéter *m* 53  
 cause *f* 180  
 caution *f* 181  
 cavalier *m* 242, 272  
 caverne *f* 284  
 CD *m* 269  
 cèdre *m* 296  
 ceinture *f* 32, 35, 36,  
 236  
 ceinture à outils *f* 186  
 ceinture de plomb *f* 239



- ceinture de sécurité *f*  
198
- ceinture de sécurité *f*  
211
- ceinture noire *f* 237
- céleri *m* 122, 124
- cellule *f* 94, 181
- cedre *f* 283
- cedres d'os *f* 88
- cedrier *m* 150
- cent 308
- cent dix 308
- cent mille 308
- centième 309
- centimètre *m* 276, 310
- centre *m* 164
- centre commercial *m*  
104
- centre de pisciculture *m*  
183
- cerceau *m* 277
- cercle *m* 165
- cercle central *m* 222,  
224, 226
- cercle de jeu *m* 224
- cercle polaire arctique *m*  
283
- céréale *f* 130
- céréales *f* 107, 130, 156
- céréales traitées *f* 130
- cérémonie de la remise  
des diplômes *f* 169
- cerf *m* 291
- cerise *f* 126
- cerveau *m* 19
- césarienne *f* 52
- cette semaine 307
- chaîne *f* 36, 178, 206,  
269
- chaîne à péage *f* 269
- chaîne de montagnes *f*  
282
- chaîne de sûreté *f* 59
- chaîne hi-fi *f* 268
- chair *f* 127, 129
- chaise *f* 64
- chaise haute *f* 75
- chaise roulante *f* 48
- chaise tournante *f* 172
- chambre *f* 58, 70, 283
- chambre à air *f* 207
- chambre à deux lits *f*  
100
- chambre d'enfants *f* 74
- chambre d'eau *f* 61
- chambre double *f* 100
- chambre noire *f* 271
- chambre privée *f* 48
- chambre simple *f* 100
- chambres *f* 100
- chameau *m* 291
- champ *m* 182
- champ central *m* 228
- champ droit *m* 229
- champ extérieur *m* 229
- champ gauche *m* 228
- champ intérieur *m* 228
- champagne *m* 145
- champignon *m* 125
- championnat *m* 223, 230
- champs de courses *m*  
243
- changer de chaîne 269
- changer de vitesse 207
- changer une roue 203
- chanson *f* 259
- chanteur *m* 258
- chanteuse *f* 191
- chantier *m* 186
- chantier naval *m* 217
- chapeau *m* 36
- chapeau de plage *m*  
265
- chapeau de soleil *m* 30
- chapelure *f* 139
- charbon *m* 288
- charbon de bois *m* 266
- charcuterie *f* 107, 142
- chardon *m* 297
- charger 76
- chariot *m* 48, 213
- chariot de levage *m*  
186
- chariot élévateur *m* 216
- chasse-d'eau *f* 61
- chasseur *m* 211
- châssis *m* 203
- chat *m* 290
- châtaigne d'eau *f* 124
- châtain 39
- château *m* 300
- château de sable *m* 265
- chaton *m* 290
- chaud 286, 321
- chaudière *f* 61
- chauffeur de taxi *m* 190
- chaussettes *f* 33
- chaussons *m* 30
- chaussure *f* 220, 223,  
233
- chaussure à talon *f* 37
- chaussure compensée  
*f* 37
- chaussure de ski *f* 246
- chaussure lacée *f* 37
- chaussures *f* 34, 37
- chaussures de marche  
*f* 267
- chaussures en cuir *f* 32
- chauve 39
- chauve-souris *f* 290
- chaux *f* 85
- chavirer 241
- cheddar *m* 142
- chef *m* 24, 190
- chef d'orchestre *m* 256
- chef de cuisine *m* 152
- cheminée *f* 58, 63, 214,  
283
- chemise *f* 33, 35
- chemise de nuit *f* 31, 35
- chemisier *m* 34
- chêne *m* 296
- chenille *f* 295
- chèque *m* 96
- chercher 177
- cheval *m* 185, 235, 242
- cheval d'arçons *m* 235
- cheval de course *m* 243
- chevalet *m* 174, 258,  
274
- cheveux *m* 14, 38
- cheville *f* 13, 15, 259
- chèvre *m* 185
- chevreau *m* 185
- chèvrefeuille *m* 297
- chevron *m* 186
- chewing-gum *m* 113
- chiche-kébab *m* 158
- chicorée *f* 123
- chien *m* 290
- chien assis *m* 58
- chiffon *m* 77
- chignon *m* 39
- Chili 315
- chimie *f* 162
- Chine 318
- chiot *m* 290
- chips *f* 113, 151
- chiropractie *f* 54
- chirurgie *f* 48
- chirurgien *m* 48
- chirurgie esthétique *f* 49
- choc *m* 47
- choc électrique *m* 46
- chocolat *m* 113
- chocolat au lait *m* 113
- chocolat blanc *m* 113
- chocolat chaud *m* 144
- chocolat en poudre *m*  
148
- chocolat noir *m* 113
- chœur *m* 301
- choqué 25
- chorizo *m* 143
- chou *m* 123
- chou chinois *m* 123
- chou de Bruxelles *m* 122
- chou frisé *m* 123
- chou précocé *m* 123
- chouette *f* 292
- chou-fleur *m* 124
- chou-rave *m* 123
- chronomètre *m* 166, 234
- chrysanthème *m* 110
- chute *f* 237
- chutney *m* 134
- Chypre 316
- cible *f* 249, 273
- ciboule *f* 125
- ciboulette *f* 133
- cidre *m* 145
- cigare *m* 112
- cigarettes *f* 112
- cigogne *f* 292
- cil *m* 14, 51
- ciment *m* 186
- cinéma *m* 255, 299
- cinq 308
- cinq cents 308
- cinquante-cinq mille cinq  
cents 309
- cinquante 308
- cinquante mille 309
- cinquantième 309
- cinquième 309
- cintré *m* 70
- circonférence *f* 164
- circulation *f* 194
- cire *f* 77
- cirer 77
- cisaille *f* 89
- ciseaux *m* 38, 47, 82,  
276
- ciseaux à ongles *m* 41
- Cité du Vatican *f* 316
- citron *m* 126
- citron et glaçons 151
- citron vert *m* 126
- citronnelle *f* 133
- citrouille *f* 125
- clair 41, 321
- clam *f* 121
- claquette *f* 179
- clarinette *f* 257
- clarinette basse *f* 257
- classe *f* 163
- classe affaires *f* 211
- classe économique *f* 211
- classeur 172
- classeur à levier 173
- clavicule *f* 17
- clavier 97, 99, 172, 176
- clayette *f* 67
- clé de fa *f* 256
- clé de sol *f* 256
- clé USB *f* 176
- clef *f* 59, 80, 207
- clef à molette *f* 80
- clef à pipe *f* 80
- clef de la chambre *f* 100
- clef serre-tube *f* 81
- clémentine *f* 126
- client *m* 96, 100, 104,  
106, 152, 175, 180
- cliente *f* 38
- clignotant *m* 198, 204
- climatisation *f* 200
- clinique *f* 48
- clipboard 173
- clitoris *m* 20
- clôture *f* 85, 182
- clou *m* 80
- clou de girofle *m* 133
- clubs de golf *m* 233
- coccinelle *f* 295
- coccyx *m* 17
- cocher 233
- cochon *m* 185
- cockpit *m* 210
- cocktail *m* 151
- cocon *m* 295
- cocotte *f* 69
- coquille *f* 129
- code barres *m* 106
- code postal *m* 98
- code secret *m* 96
- cœur *m* 18, 119, 122,  
273
- cœurs de palmier *m* 122
- coffre *m* 198
- coiffeur *m* 39, 188
- coiffeuse *f* 38, 71
- coiffures *f* 39
- coin de la rue *m* 298
- coing *m* 128
- col *m* 32
- col de l'utérus *m* 20
- col de l'utérus *m* 52
- col rond *m* 33
- cola *m* 144
- colibri *m* 292
- colis *m* 99
- collage *m* 275
- collant *m* 35, 251
- colle *f* 275
- colle à bois *f* 78
- colle à tapisser *f* 82
- collègue *m* 24
- collier *m* 36
- colline *f* 284
- Colombie 315
- colonie 315
- colonne *f* 300
- colonne vertébrale *f* 17
- colza *m* 184
- combat *m* 237
- combinaison *f* 35
- combinaison de neige *f*  
30
- combinaison de plongée *f*  
239
- combinaison-short *f* 30
- combiné *m* 99
- comédie *f* 255
- comédie musicale *f* 255
- comédie romantique *f*  
255
- comédienne *f* 191
- comète *f* 280
- commande *f* 269
- commander 153
- commandes *f* 201, 204
- commencer à l'école 26
- commis *m* 152
- commission *f* 97
- commode *f* 70
- commotion cérébrale *f* 46
- communications *f* 98
- Comores 317
- compartment *m* 209
- compartment à  
bagages *m* 196
- compartment-  
couchettes *m* 209
- compas *m* 165, 240
- complet 129, 131, 266
- composer 99
- compositions florales  
*f* 111

- comptabilité *f* 175  
 comptable *m* 97, 190  
 compte courant *m* 96  
 compte e-mail *m* 177  
 compte d'épargne *m* 97  
 compte rendu *m* 174  
 compte-gouttes *m* 109, 167  
 compter 165  
 compte-tours *m* 201  
 compteur *m* 201, 204  
 compteur d'électricité *m* 60  
 comptoir *m* 96, 100, 142, 150  
 comptoir sandwichs *m* 143  
 conception *f* 52  
 concert *m* 255, 258  
 concert de rock *m* 258  
 concevoir 20  
 concombre *m* 125  
 condamnation *f* 181  
 conditionnement  
   physique *m* 250  
 condom *m* 21  
 conducteur *m* 196  
 conducteur de bus *m* 190  
 conduit éjaculatoire *m* 21  
 conduit spermatique *m* 21  
 conduite à droite *f* 201  
 conduite à gauche *f* 201  
 conduite d'amenée *f* 61  
 cône *m* 164, 187  
 conférencière *f* 174  
 confiant 25  
 confiserie *f* 107, 113  
 confiseur *m* 113  
 confiture *f* 134, 156  
 confiture de framboises *f* 134  
 confiture d'oranges *f* 134, 156  
 confus 25  
 congélateur *m* 67  
 congeler 67  
 conglomerat *m* 288  
 Congo 317  
 conifère *m* 86  
 connaissance *m* 24  
 connecter 177  
 conseil juridique *m* 180  
 conseillère *f* 55  
 conseillère financière *f* 97  
 Conservatoire *m* 169  
 conserves *f* 107  
 console *f* 269  
 constellation *f* 281  
 consterné 25  
 construction *f* 186  
 construire 186  
 consultation *f* 45  
 conteneur *m* 216  
 continent *m* 282, 315  
 contraception *f* 21, 52  
 contraction *f* 52  
 contrat *m* 175  
 contrebasse *f* 256  
 contrebasson *m* 257  
 contrefort *m* 301  
 contreplaqué *m* 79  
 contrôle de passeports *m* 213  
 contrôleur *m* 209  
 contusion *f* 46  
 convecteur *m* 60  
 copeaux *m* 78  
 copilote *m* 211  
 coq *m* 185  
 coque *f* 121, 214, 240  
 coquelicot *m* 297  
 coquetier *m* 65, 137  
 coquillage *m* 265  
 coquille *f* 137  
 coquille Saint-Jacques *f* 121  
 cor *m* 257  
 cor anglais *m* 257  
 corbeille *m* 292  
 corbeille *f* 254  
 corbeille à couture *f* 276  
 corbeille à papier 172  
 corbeille arrivée 172  
 corbeille de fruits *f* 126  
 corbeille départ 172  
 corde *f* 248, 258, 266  
 corde à linge *f* 76  
 cordes *f* 256  
 cordes vocales *f* 19  
 cordon ombilical *m* 52  
 Corée du Nord 318  
 Corée du Sud 318  
 coriandre *f* 133  
 corne 293  
 cornée *f* 51  
 corner *m* 223  
 corniche *f* 300  
 corps *m* 12  
 correcteur *m* 40  
 correspondance *f* 212  
 correspondant *m* 24  
 Corse 316  
 corset *m* 35  
 Costa Rica 314  
 costume *m* 32, 255  
 côte *f* 17, 285  
 côté *m* 164  
 côte de bœuf *f* 119  
 Côte d'Ivoire 317  
 côtelette *f* 119  
 côtes *f* 155  
 coton *m* 184, 277  
 cottage *m* 136  
 cou *m* 12  
 couche *f* 75  
 couche de fond *f* 83  
 couche d'ozone *f* 286  
 couche éponge *f* 30  
 couche jetable *f* 30  
 coucher *m* 74  
 coucher du soleil *m* 305  
 coude *m* 13  
 cou-de-pied *m* 15  
 coudre 277  
 couenne *f* 119  
 couette *f* 71  
 couettes *f* 39  
 couffin *m* 75  
 couleur *f* 273  
 couleur pour bois *f* 79  
 couleurs *f* 39, 274  
 coulisses *f* 254  
 couloir *m* 168, 210, 234, 238  
 country *f* 259  
 coup *m* 151, 233, 237, 273  
 coup de pied *m* 237, 239  
 coup de poing *m* 237  
 coup de soleil *m* 46  
 coup droit *m* 231  
 coup du lapin *m* 46  
 coup franc *m* 222  
 coup manqué *m* 228  
 coupable 181  
 coupe *f* 91  
 coupé 99  
 coupe courte *f* 39  
 coupe-ongles *m* 41  
 couper 38, 67, 277  
 coupe-tube *m* 81  
 couple *m* 24  
 coups *m* 231  
 coupure *f* 46  
 coupure de courant *f* 60  
 cour *f* 58, 84  
 cour de ferme *f* 182  
 courant *m* 60  
 courant alternatif *m* 60  
 courant continu *m* 60  
 courbe 165  
 courbe *f* 48  
 coureur automobile *m* 249  
 courge *f* 124, 125  
 courge musquée *f* 125  
 courgette *f* 125  
 courir 228  
 couronne *f* 50, 111  
 courroie de cames *f* 203  
 courroie de ventilateur *f* 203  
 course *f* 234  
 course attelée *f* 243  
 course automobile *f* 249  
 course de chevaux *f* 243  
 course de moto *f* 249  
 course de plat *f* 243  
 course de trot *f* 243  
 courser 229  
 courses *f* 104, 243  
 court 321  
 court de tennis *m* 230  
 couscous *m* 130  
 cousin *m* 22  
 coussin *m* 62  
 coussinets *m* 53  
 couteau *m* 65, 80, 121  
 couteau à pain *m* 68  
 couteau de cuisine *m* 68  
 couture *f* 34  
 couturier *m* 191  
 couturière *f* 191, 277  
 couvercle *m* 61, 66  
 couvert *m* 65  
 couverts *m* 64  
 couverture *f* 71, 74  
 couverture chauffante *f* 71  
 couverture de protection *f* 83  
 couverture du sol *f* 87  
 couverture laineuse *f* 74  
 couveuse *f* 53  
 couvre-lit *m* 70  
 crabe *m* 121, 295  
 crachoir *m* 50  
 craie *f* 162, 288  
 craie de tailleur *f* 276  
 crampe *f* 239  
 crampes *f* 44  
 crâne *m* 17  
 crapaud *m* 294  
 cratère *m* 283  
 cravache *f* 242  
 cravate *f* 32  
 crawl *m* 239  
 crayon *m* 163, 275  
 crayon à lèvres *m* 40  
 crayon à sourcils *m* 40  
 crayon de couleur *m* 163  
 crème *f* 109, 137, 157  
 crème *m* 148  
 crème allégée *f* 137  
 crème anglaise *f* 140  
 crème caramel *f* 141  
 crème épaisse *f* 137  
 crème fouettée *f* 137  
 crème fraîche *f* 137  
 crème hydratante *f* 41  
 crème pâtissière *f* 140  
 crème pour le visage *f* 73  
 crème pour l'érythème *f* 74  
 crémérie *f* 107  
 crêpes *f* 155, 157  
 crépuscule *m* 305  
 cresson *m* 123  
 creuset *m* 166  
 creux des reins *m* 13  
 crevaison *f* 203, 207  
 crevette *f* 121  
 crevettes décortiquées *f* 120  
 cric *m* 203  
 cricket *m* 225  
 crier 25  
 crime *m* 94  
 criminel *m* 181  
 crinière *f* 242, 291  
 crise cardiaque *f* 44  
 cristallin *m* 51  
 Croatie 316  
 crochet *m* 187, 277  
 crocodile *m* 293  
 croissant *m* 156  
 croissant de lune *m* 280  
 croquant 127  
 croquis *m* 275  
 crosse *f* 224, 249  
 crosse de hockey *f* 224  
 croûte *f* 136, 139, 142  
 cru 124, 129  
 Cuba 314  
 cube *m* 164  
 cubitus *m* 17  
 cueillir 91  
 cuiller *f* 65  
 cuiller à café *f* 65, 153  
 cuiller à glace *f* 68  
 cuiller à servir *f* 68  
 cuiller à soupe *f* 65  
 cuiller en bois *f* 68  
 cuiller pour mesurer *f* 109  
 cuir chevelu *m* 39  
 cuire à la vapeur 67  
 cuire au four 67  
 cuisine *f* 66, 67, 152, 214  
 cuisse *f* 12, 119  
 cuit 159  
 cuit à la vapeur 159  
 cuivre *m* 289  
 cuivres *m* 256  
 culasse *f* 202  
 culotte en plastique *f* 30  
 cultivateur *m* 182  
 cultiver 91  
 culture *f* 183  
 cultures *f* 184  
 cumin *m* 132  
 curcuma *m* 132  
 curling *m* 247  
 curry *m* 158  
 cutter *m* 82  
 cuvette *f* 61  
 cygne *m* 293  
 cylindre *m* 164  
 cymbales *f* 257

## D

- d'accord 322  
 dames *f* 272, 273  
 dames *f* 272  
 dance *f* 259  
 Danemark 316  
 danger *m* 195  
 dans 320  
 danseuse *f* 191  
 dard *m* 295  
 date *f* 306  
 date d'expiration *f* 109  
 date de retour *f* 168

- date du procès *f* 180  
 datte *f* 129  
 dauphin *m* 290  
 daurade *f* 120  
 de 320  
 dé *m* 272  
 dé à coudre *m* 276  
 de ferme 118  
 de rien 322  
 de saison 129  
 de troisième cycle 169  
 débarquer 217  
 début *m* 321  
 décapotable *f* 199  
 décembre *m* 306  
 décennie *f* 307  
 déchets bios *m* 61  
 déclencher  
   l'accouchement 53  
 déclencheur *m* 270  
 décoller 82, 211  
 décongeler 67  
 décontracté 34  
 décor *m* 254  
 décor de cinéma *m* 179  
 décoration *f* 82, 141  
 décortiqué 129  
 découper 79  
 découvert *m* 96  
 décréter 39  
 défaire 277  
 défense *f* 181, 220, 291  
 défenseur *m* 223  
 défilé *m* 27  
 dehors 320  
 déjeuner *m* 64  
 déjeuner d'affaires *m*  
   175  
 deltaplane *m* 248  
 deltoïde *m* 16  
 demain 306  
 démaquillant *m* 41  
 demi-heure 304  
 demi-litre *m* 311  
 demi-pension *f* 101  
 démonte-pneu *m* 207  
 dénominateur *m* 165  
 dent *f* 50  
 dentelle *f* 35, 277  
 dentier *m* 50  
 dentifrice *m* 72  
 dentiste *f* 189  
 dentiste *m* 50  
 déodorant *m* 73  
 déodorants *m* 108  
 dépanneuse *f* 203  
 départ *m* 232  
 départ plongé *m* 239  
 départs *m* 213  
 dépendance *f* 182  
 déplaçant *m* 89  
 dépliants *m* 96  
 déposition *f* 180  
 dérive *f* 210, 241  
 dermatologie *f* 49  
 dernière couche *f* 83  
 derrière 320  
 descente *f* 247  
 désert *m* 285  
 désherber 91  
 dessert *m* 153  
 desserts *m* 140  
 dessin *m* 162, 275  
 dessin animé *m* 178  
 dessinatrice *f* 191  
 dessiner 91, 162  
 dessous de verre *m* 150  
 dessus 98  
 destination *f* 213  
 détecteur de fumée *m*  
   95  
 détergent *m* 77  
 deux 308  
 deux cents 308  
 deux heures 304  
 deux mille 307  
 deux pintes 311  
 deuxième 309  
 deuxième étage *m* 104  
 deuxième galerie *f* 254  
 devant 320  
 développer 271  
 déviation *f* 195  
 dévidoir de scotch 173  
 dévidoir de tuyau *m* 89  
 devises étrangères *f* 97  
 devoirs *m* 163  
 diabète *m* 44  
 diable *m* 100  
 diagonale *f* 164  
 diamant *m* 288  
 diamètre *m* 164  
 diaphragme *m* 21, 19  
 diarrhée *f* 44, 109  
 dictionnaire *m* 163  
 diète *m* 256  
 diesel *m* 199  
 difficile 321  
 digestif 19  
 digitale *f* 297  
 dilatation *f* 52  
 dimanche *m* 306  
 dimensions *f* 165  
 dinde *f* 119  
 dindon *m* 185, 293  
 dîner *m* 64  
 dioptrie *f* 51  
 diplomate *m* 141  
 diplôme *m* 169  
 directeur *m* 163, 174  
 directeur d'agence *m* 96  
 directeur général *m* 175  
 directions *f* 260  
 disc-jockey *m* 179  
 discuter 163  
 disque *m* 234  
 dissertation *f* 169  
 dissolvant *m* 41  
 distance *f* 310  
 distractions à la maison  
   *f* 268  
 distributeur *m* 97, 203  
 distribution *f* 98, 254  
 district *m* 315  
 dividendes *f* 97  
 divisé par 165  
 diviser 165  
 divorce *m* 26  
 Diwali *f* 27  
 dix 308  
 dix mille 309  
 dix-huit 308  
 dix-huitième 309  
 dixième 309  
 dix-neuf 308  
 dix-neuvième 309  
 dix-sept 308  
 dix-septième 309  
 Djibouti 317  
 dock *m* 214, 216  
 docteur *m* 189  
 doctorat *m* 169  
 documentaire *m* 178  
 dôme *m* 300  
 Dominie 314  
 dominos *m* 273  
 donner 273  
 donner à manger 183  
 donner le sein 53  
 dorsal *m* 16  
 dos *m* 13  
 dos crawlé *m* 239  
 dos du pied *m* 15  
 dos-nu 35  
 dossier *m* 210  
 dossier *m* 177  
 dossier suspendu 173  
 dossier-classeur 173  
 douane *f* 212  
 double *m* 230  
 double 151  
 double toit *m* 266  
 doubler 195  
 doublure *f* 32  
 douche *f* 72  
 douches *f* 266  
 douille *f* 69, 80  
 douve *f* 300  
 douze 308  
 douzième 309  
 dragée à la gelée *f* 113  
 drainage *m* 91  
 drap *m* 71, 74  
 drapeau *m* 221, 232,  
   235  
 drapeau de coin *m* 223  
 dressage *m* 243  
 dribbler 223  
 driver 233  
 droit *m* 169, 180  
 droite 165  
 drummer *m* 258  
 duffel-coat *m* 31  
 dumper *m* 187  
 duodénum *m* 18  
 dur 129, 321  
 DVD *m* 269  
 dynamo *f* 207  
**E**  
 eau *f* 144, 238  
 eau de Javel  
 eau de toilette *f* 41  
 eau dentifrice *f* 72  
 eau du robinet *m* 144  
 eau en bouteille *f* 144  
 eau minérale *f* 144  
 écaille *f* 121, 294  
 écaillé 121  
 écailles *f* 293  
 échafaudage *m* 186  
 échalone *m* 125  
 échange *m* 230  
 écharde *f* 46  
 écharpe *f* 31, 46  
 échecs *m* 272  
 échelle *f* 95, 186  
 écheveau *m* 277  
 échiquier *m* 272  
 échographie *f* 52  
 éclair *m* 140, 287  
 éclairage *m* 105, 178  
 éclipse *f* 280  
 école *f* 162, 299  
 école de danse *f* 169  
 école des beaux arts *f*  
   169  
 écoles *f* 169  
 écolier *m* 162  
 écolière *f* 162  
 écorce *f* 127, 282, 296  
 écorchure *f* 46  
 écoute *f* 241  
 écouteurs *m* 268  
 écran *m* 97, 176, 255,  
   269  
 écran d'information *m*  
   213  
 écran de protection *m*  
   88  
 écran solaire *m* 108  
 écran total *m* 108, 265  
 écrasé 132  
 écrevisse *f* 121  
 écrire 162  
 écrou *m* 80  
 écrous de roue *m* 203  
 écume *f* 241  
 écumoire *f* 68  
 écreuil *m* 290  
 écurie *f* 185, 243  
 eczéma *m* 44  
 édam *m* 142  
 édredon *m* 71  
 éducation physique *f*  
   162  
 effet *m* 230  
 effets secondaires *m*  
   109  
 effrayé 25  
 égale 165  
 égalité *f* 223, 230  
 église *f* 298, 300  
 égout *m* 299  
 égouttoir *m* 67  
 Égypte 317  
 élaguer 91  
 élastique 173  
 élastique pour cheveux *m*  
   39  
 électricien *m* 188  
 électricité *f* 60  
 électrode négative *f* 167  
 électrode positive *f* 167  
 électroménager *m* 107  
 éléphant *m* 291  
 élève *m* 162  
 e-mail *m* 177  
 email *m* 50  
 emballage *m* 111  
 embarcadère *f* 217  
 embarquer 217  
 embouteillage *m* 195  
 embouts de tournevis *m*  
   80  
 embrayage *m* 200, 204  
 embryon *m* 52  
 émeraude *f* 288  
 émettre 178  
 émigrer 26  
 Émirats arabes unis 318  
 émission *f* 179  
 émotions *f* 25  
 empennage *m* 210  
 emplacement *m* 266  
 emplacements libres 266  
 employé *m* 24  
 employée de magasin *f*  
   188  
 employeuse *f* 24  
 empoisonnement *m* 46  
 empreintes *f* 94  
 emprunter 168  
 en bas 320  
 en différé 178  
 en direct 178  
 en face de 320  
 en filets 121  
 en flocons 132  
 en haut 320  
 en ligne 177  
 en morceaux 132  
 en poudre 132  
 en purée 159  
 en sauce 159  
 en saumure 143  
 en verre 69  
 encaisser 97  
 enceinte 52  
 enclos *m* 185, 242  
 enclore en V *f* 33  
 encre *f* 275  
 encyclopédie *f* 163  
 endive *f* 122  
 endocrine 19  
 endocrinologie *f* 49  
 enduit *m* 83  
 enfant *m* 23  
 enfant *m* 31  
 enfants *m* 23  
 enfiler 277

- engrais *m* 91  
 enjoliveur *m* 202  
 enlèvement de déchets *m* 61  
 enlever les fleurs fanées 91  
 ennuyé 25  
 enquête *f* 94  
 enregistrement des bagages *m* 213  
 enregistrer 212, 269  
 enrobé de chocolat 140  
 enseigne *f* 104  
 enseignement supérieur *m* 168  
 ensoleillé 286  
 enterrement *m* 26  
 en-tête 173  
 entonnoir *m* 166  
 entorse *f* 46  
 entracte *m* 254  
 entraînement *m* 237  
 entraînement en circuit *m* 251  
 entraînement poids et haltères *m* 251  
 entraîneuse *f* 250  
 entre 320  
 entrée *f* 58, 59, 153  
 entrepôt *m* 216  
 entrer 177  
 entrer en éruption 283  
 enveloppe *f* 98, 173  
 environnement *m* 280  
 environs *m* 299  
 envoi en recommandé *m* 98  
 envoyer 177  
 épais 321  
 épargne *f* 96  
 épaupe *f* 13  
 épauvette *f* 35  
 épeler 162  
 épiché 124  
 épicerie *f* 114  
 épices *f* 132  
 épiglotte *f* 19  
 épilation *f* 41  
 épilepsie *f* 44  
 épinards *m* 123  
 épingle *f* 276  
 épingle de cravate *f* 36  
 épingle de sûreté *f* 47  
 épisiotomie *f* 52  
 épiluche-légume *m* 68  
 épilucher 67  
 éponge *f* 73, 74, 83  
 épousseter 77  
 épouvantail *m* 184  
 épreuve *f* 271  
 épreuves *f* 247  
 éprouvette *f* 166  
 épuisette *f* 244  
 Équateur 315  
 équateur *m* 283  
 équation *f* 165
- équerre *f* 165  
 équipage *m* 241  
 équipe *f* 220, 229  
 équipement *m* 165, 233, 238  
 équipement de bureau 172  
 équipement d'entretien *m* 77  
 équitation *f* 242, 263  
 érable *m* 296  
 éruption *f* 44  
 Érythrée 317  
 escabeau *m* 82  
 escalade *f* 248  
 escalade en glace *f* 247  
 escalator *m* 104  
 escalier *m* 59  
 escalier de secours *m* 95  
 escalier d'entraînement 250  
 escargot *m* 295  
 escrime *f* 249  
 espace *m* 280  
 espadon *m* 120, 294  
 Espagne 316  
 essai *m* 221  
 essence *f* 199  
 essieu *m* 205  
 essorer 76  
 essoreuse *f* 76  
 essuie-glace *m* 198  
 essuyer 77  
 est *m* 312  
 estomac *m* 18  
 Estonie 316  
 estragon *m* 133  
 estuaire *m* 285  
 établi *m* 78  
 étage inférieur *m* 141  
 étage supérieur *m* 141  
 étagère *f* 66, 106, 268  
 étain *m* 289  
 étaler au rouleau 67  
 étamine *f* 297  
 État *m* 315  
 États-Unis d'Amérique 314  
 étau *m* 78  
 été *m* 31, 307  
 éteindre la télévision 269  
 étendre 251  
 éternuement *m* 44  
 Éthiopie 317  
 étiquette 173  
 étiquettes *f* 89  
 étirement *m* 251  
 étoile *f* 280  
 étoile de mer *f* 295  
 étouffer 47  
 être en défense 229  
 étrier *m* 242  
 étroit 321  
 étude *f* 162  
 études d'ingénieur *f* 169
- étudiant *m* 169  
 étui *m* 51  
 étui à lentilles *m* 51  
 eucalyptus *m* 296  
 Europe 316  
 événements de la vie *m* 26  
 évier *m* 290  
 évier *m* 61, 66  
 examen *m* 163  
 examen de la vue *m* 51  
 examen médical *m* 45  
 excédent de bagages *m* 212  
 excité 25  
 exécuter un swing 232  
 exercice pour la poitrine *m* 251  
 exercice pour les biceps *m* 251  
 exercices *m* 251  
 exercices au sol *m* 235  
 exfolier 41  
 exosphère *f* 286  
 expéditeur *m* 98  
 expérience *f* 166  
 exploitation fruitière *f* 183  
 exploitations agricoles *f* 183  
 exploration spatiale *f* 281  
 exposition *f* 261  
 expresso *m* 148  
 expulsion *f* 223  
 extérieur *m* 198  
 extincteur *m* 95  
 extraction *f* 50  
 eye-liner *m* 40
- F**  
 fâché 25  
 facile 321  
 facile à cuisiner 130  
 facteur *m* 98, 190  
 faible 321  
 faire du pain 138  
 faire cuire au four 138  
 faire du vélo 207  
 faire le lit 71  
 faire marche arrière 195  
 faire rebondir 227  
 faire son testament 26  
 faire un dunk 227  
 faire un vœu 140  
 faire une manchette 227  
 faire une mise en plis 38  
 faire une passe 220, 223  
 faire une réservation de vol 212  
 faire une tête 222  
 fairway *m* 232  
 faisán *m* 119, 293  
 fait-tout *m* 69  
 falaise *f* 285  
 famille *f* 22  
 fans *m* 258  
 farci 159
- fard à joues *m* 40  
 fard à paupières *m* 40  
 farine *f* 138  
 farine avec la levure chimique *f* 139  
 farine blanche *f* 138  
 farine brute *f* 138  
 farine complète *f* 138  
 farine sans levure chimique *f* 139  
 farine traitée *f* 139  
 faucon *m* 292  
 fausse couche *f* 52  
 faute *f* 222, 226, 230  
 fauteuil *m* 63, 254  
 fauteuil de dentiste *m* 50  
 fax 172  
 fax *m* 98  
 Fédération de Russie 318  
 féminin 20  
 femme *f* 12, 22, 23  
 femme d'affaires *f* 175  
 fémur *m* 17  
 fendoir *m* 68  
 fenêtre *f* 58, 177, 186, 197, 209  
 feng shui *m* 55  
 fenouil *m* 122, 133  
 fente *f* 97  
 fente avant *f* 251  
 fenugrec *m* 132  
 fer *m* 109, 233, 289  
 fer à cheval *m* 242  
 fer à friser *m* 38  
 fer à lisser *m* 38  
 fer à repasser *m* 76  
 fer à souder *m* 81  
 ferme *f* 182, 184  
 ferme 124  
 fermé 260, 321  
 ferme d'aviculture *f* 183  
 ferme de culture *f* 183  
 ferme d'élevage de moutons *f* 183  
 ferme d'élevage porcin *f* 183  
 ferme laitière *f* 183  
 fermeture éclair *f* 277  
 fermier *m* 182, 189  
 fermoir *m* 36  
 ferry *m* 215, 216  
 fertilisation *f* 20  
 fertiliser 91  
 fesse *f* 13  
 fessier *m* 16  
 fête *f* 140  
 fête de Thanksgiving *f* 27  
 fêtes *f* 27  
 feu *m* 217  
 feu arrière *m* 204, 207  
 feu de camp *m* 266  
 feuillage *m* 110  
 feuille *f* 122, 296  
 feuille de laurier *f* 133  
 feuilles de thé *f* 144
- feuilleton *m* 178  
 feux *m* 94, 194  
 feux de détresse *m* 201  
 fève *f* 122  
 fèves *f* 131  
 février *m* 306  
 fiancé *m* 24  
 fiancée *f* 24  
 fiancés *m* 24  
 fibre *f* 127  
 fibre naturelle *f* 31  
 ficelle *f* 89  
 fiche compliments 173  
 fiche de retrait *f* 96  
 fiche intercalaire 173  
 fiches de versement *m* 96  
 fichier *m* 177  
 Fidji 319  
 fier 25  
 fièvre *f* 44  
 figue *f* 129  
 figue de Barbarie *f* 128  
 fil *m* 276  
 fil à plomb *m* 82  
 fil de fer *m* 79  
 fil dentaire *m* 50, 72  
 filament *m* 60  
 file de droite *f* 194  
 filet *m* 119, 121, 217, 222, 226, 227, 231  
 filets de flétan *m* 120  
 fille *f* 22, 23  
 film *m* 178, 269  
 film d'aventure *m* 255  
 film d'horreur *m* 255  
 film d'animation *m* 255  
 film de science-fiction *m* 255  
 fils *m* 22, 60  
 filtre *m* 270  
 filtre à air *m* 202  
 filtre d'air *m* 204  
 fin *f* 321  
 finance *f* 97  
 Finlande 316  
 fiole *f* 166  
 flageolets *m* 131  
 flamant *m* 292  
 flanc *m* 284  
 flash *m* 270  
 flash compact *m* 270  
 flèche *f* 95, 249, 300  
 fléchettes *f* 273  
 fléchir 251  
 fleur *f* 297  
 fleuret *m* 249  
 fleurette *f* 122  
 fleuriste *f* 188  
 fleuriste *m* 110  
 fleuron *m* 300  
 fleurs *f* 110  
 fleurs séchées *f* 111  
 flexion de jambes *f* 251  
 florentin *m* 141  
 flotteur *m* 61, 244

- flou 271  
flûte *f* 139, 257  
fœtus *m* 52  
foie *m* 18, 118  
foin *m* 184  
foire *f* 262  
fois 165  
follicule *m* 20  
foncé 41, 321  
fond de teint *m* 40  
fontaine *f* 85  
fontaine publique *f* 262  
foot *m* 222  
football américain *m* 220  
forceps *m* 53, 167  
forêt *f* 285  
foret à bois plat *m* 80  
foret à métaux *m* 80  
foret de maçonnerie *m* 80  
foret de sécurité *m* 80  
forêt tropicale *f* 285  
forets *m* 80  
forets à bois *m* 80  
formes *f* 164  
fort 321  
fosse d'orchestre *f* 254  
fossette *f* 15  
fou *m* 272  
fouet *m* 68  
fougère *f* 86  
foulard *m* 36  
four *m* 66  
fourche *f* 88, 207  
fourches *f* 39  
fourchette *f* 65, 153  
fourchette à découper *f* 68  
fourmi *f* 295  
fourneau *m* 112  
fournitures de bureau 173  
fourre-tout *m* 37  
foyer *m* 255  
fraction *f* 165  
fracture *f* 46  
fragile 98  
frais 121, 127, 130  
frais bancaires *m* 96  
fraise *f* 50, 127  
framboise *f* 127  
France 316  
frange de lit *f* 71  
frapper 224, 225  
freesia *m* 110  
freezer *m* 67  
frein *m* 204  
frein *m* 200, 206  
frein à main *m* 203  
freiner 207  
fréquence *f* 179  
frère *m* 22  
friandise *f* 113  
frîre 67  
frise *f* 301  
frisé 39
- frit 159  
frites *f* 154  
froid 286, 321  
fromage *m* 136, 156  
fromage à la crème *m* 136  
fromage à pâte molle *m* 136  
fromage à pâte pressée cuite *m* 136  
fromage à pâte pressée non cuite *m* 136  
fromage à pâte semi-molle *m* 136  
fromage de chèvre *m* 142  
fromage frais *m* 136  
fromage râpé *m* 136  
froncement de sourcils *m* 25  
front *m* 14  
frontail *m* 242  
frontal *m* 16  
fronton *m* 301  
fruit confit *m* 129  
fruit de feijoa *m* 128  
fruit de l'arbre à pain *m* 124  
fruit de la passion *m* 128  
fruits *m* 107, 126, 128, 157  
fruits à noyau *m* 126  
fruits de mer *m* 121  
fruits en bocaux *m* 134  
fruits secs *m* 156  
fruits tropicaux *m* 128  
fumé 118, 121, 143, 159  
fumée *f* 95  
fumer 112  
fumer en surface 90  
fusain *m* 275  
fuseau *m* 277  
fusée d'orientation *f* 281  
fusée éclairante *f* 240  
fuselage *m* 210  
fusible *m* 60  
fusil *m* 118
- G**  
Gabon 317  
gagnant *m* 273  
gagner 273  
galaxie *f* 280  
galerie *f* 198  
galerie à vélo *f* 207  
gallon *m* 311  
galop *m* 243  
galvanisé 79  
Gambie 317  
gamme *f* 256  
gant *m* 224, 228, 233, 236, 246  
gant isolant *m* 69  
gants *m* 36  
gants de boxe *m* 237  
gants de jardinage *m* 89
- garage *m* 58, 199, 203  
garçon *m* 23, 152  
garde *m* 189  
garde-boue *m* 205  
garde-côte *m* 217  
gardien de but *m* 222  
gardien de guichet *m* 225  
gardien de prison *f* 181  
gare *f* 208  
gare routière *f* 197  
garer 195  
garniture *f* 140, 155  
gâteau au chocolat *m* 140  
gâteau d'anniversaire *m* 141  
gâteau de mariage *m* 141  
gâteau de miel *m* 135  
gâteaux *m* 140  
gâteaux de fête *m* 141  
gaufres *f* 157  
gaze *f* 47  
gazeux 144  
gazonner 90  
gel *m* 38, 109, 287  
gel douche *m* 73  
gélule *f* 109  
gemmes *f* 288  
gencive *f* 50  
gendre *m* 22  
géné 25  
génération *f* 23  
génératrice *f* 60  
genou *m* 12  
genouillère *f* 227  
genres de pêche *m* 245  
genres de plantes *m* 86  
gens 12, 16  
géographie *f* 162  
géométrie *f* 165  
Géorgie 318  
gerbera *m* 110  
germe de soja *m* 122  
germoir *m* 89  
geyser *m* 285  
Ghana 317  
gibier *m* 119  
gigot *m* 119  
gilet *m* 33  
gilet de sauvetage *m* 240  
gin *m* 145  
gin tonic *m* 151  
gingembre *m* 125, 133  
girafe *f* 291  
giroflée *f* 110  
givre *m* 287  
glaçage *m* 141  
glace *f* 120, 137, 149, 287  
glacer 139  
glacier *m* 284  
glaçon *m* 151, 287  
glaïeul *m* 110
- glande *f* 19  
glisser 229  
glissière de sécurité *f* 195  
gneiss *m* 288  
golf *m* 232  
gomme *f* 163  
gong *m* 257  
gorge *f* 19, 284  
gorille *m* 291  
gotique 301  
gouache *f* 274  
gourde amère *f* 124  
gousse *f* 122, 125  
gouttes *f* 109  
gouttière *f* 58  
gouvernail *m* 241  
gouverne *f* 210  
goyave *f* 128  
GPS *m* 195  
grain *m* 122, 130  
grain de beauté *m* 14  
grain de moutarde *m* 131  
grain de poivre *m* 132  
graine *f* 122, 130  
graine de carvi *f* 131  
graine de potiron *f* 131  
graine de sésame *f* 131  
graine de tournesol *f* 131  
graines *f* 88, 131  
graines de fenouil *f* 133  
graines de pavot *f* 138  
graines de soja *f* 131  
grains *m* 144  
gramme *m* 310  
grand 321  
grand bassin *m* 239  
grand bol *m* 69  
grand lit *m* 71  
grand magasin *m* 105  
grande aiguille *f* 304  
grande cisaille *f* 88  
grande tasse *f* 65  
grandes ondes *f* 179  
grand-mère *f* 22  
grand-père *m* 22  
grands-parents *m* 23  
grand-voile *f* 240  
grange *f* 182  
granite *m* 288  
graphite *m* 289  
gras *m* 119  
gras 39, 41  
gratte-ciel *m* 299, 300  
grattoir *m* 82  
gravier *m* 88  
gravure *f* 275  
Grèce 316  
gréement *m* 215, 240  
green *m* 232  
greffer 91  
greffier *m* 180  
grêle *f* 286  
Grenade 314
- grenade *f* 128  
grenat *m* 288  
grenier *m* 58  
grenouille *f* 294  
grenouillère *f* 30  
grès *m* 288  
griffe *f* 291  
gril *m* 69  
grillé 129, 159  
grille de refroidissement *f* 69  
grille-pain *m* 66  
griller 67  
grillon *m* 295  
grippe *f* 44  
gris 39, 274  
Groenland 314  
gros 321  
gros haricots blancs *m* 131  
gros intestin *m* 18  
gros orteil *m* 15  
groseille à maquereau *f* 127  
groseille blanche *f* 127  
grosseesse *f* 52  
grue *f* 187, 216, 292  
grue de caméra *f* 178  
Guatemala 314  
guêpe *f* 295  
guépière *f* 35  
guérison par cristaux *f* 55  
gueule *f* 293  
guichet *m* 96, 98, 209, 216, 225  
guide *m* 104, 260  
guide *m* 260  
guide de fil *m* 276  
guidon *m* 207  
guimauve *f* 113  
guimbarde *f* 78  
guideau *m* 214  
Guinée 317  
Guinée équatoriale 317  
Guinée-Bissau 317  
guirlande de fleurs *f* 111  
guitare basse *f* 258  
guitare électrique *f* 258  
Guyane 315  
Guyane française 315  
gymnase *m* 250  
gymnaste *f* 235  
gymnastique *f* 235  
gymnastique rythmique *f* 235  
gynécologie *f* 49  
gynécologue *m* 52  
gypsophile *f* 110
- H**  
habillé 34  
hache *f* 95  
haie *f* 85, 90, 182  
haies *f* 235  
Haïti 314

- hall *m* 100  
 hall de gare *m* 209  
 haltère *m* 251  
 hamac *m* 266  
 hamburger *m* 154  
 hamburger au poulet *m* 155  
 hamburger avec des frites *m* 154  
 hamburger végétarien *m* 155  
 hameçon *m* 244  
 hamster 290  
 hanche *f* 12  
 handicap *m* 233  
 haricot grim pant *m* 122  
 haricot vert *m* 122  
 haricots *m* 131  
 haricots blancs *m* 131  
 haricots mung *m* 131  
 haricots pinto *m* 131  
 haricots rouges *m* 131  
 harpe *f* 256  
 haut 321  
 haute-définition 269  
 haut-parleur *m* 176, 209  
 hautbois *m* 257  
 hauteur *f* 165  
 Hawaï 314  
 hayon *m* 198  
 heavy métal *f* 259  
 hebdomadaire 307  
 hélice *f* 211, 214  
 hélicoptère *m* 211  
 hématite *f* 289  
 hémisphère nord *m* 283  
 hémisphère sud *m* 283  
 hémorragie *f* 46  
 herbe *f* 55, 86  
 herbes *f* 133, 134  
 herbes et les épices *f* 132  
 herbicide *m* 91, 183  
 herboristerie *f* 55, 108  
 hérisson *m* 290  
 hêtre *m* 296  
 heure *f* 304  
 heure de pointe *f* 209  
 heures *f* 261  
 heures de visite *f* 48  
 heureux 25  
 hexagone *m* 164  
 hier 306  
 Himalaya *m* 313  
 hippocampe *m* 294  
 hippopotame *m* 291  
 hirondelle *f* 292  
 histoire *f* 162  
 histoire de l'art *f* 169  
 hiver *m* 31, 307  
 hochet *m* 74  
 hockey *m* 224  
 hockey sur glace *m* 224  
 hockeyeur *m* 224  
 homard *m* 121, 295  
 homéopathie *f* 55
- homme *m* 12, 23  
 homme d'affaires *m* 175  
 homme de base *m* 228  
 homogénéisé 137  
 Honduras 314  
 Hongrie 316  
 hôpital *m* 48  
 horaire *m* 197, 209, 261  
 horloge *f* 304  
 hormone *f* 20  
 hors jeu 225, 226, 228  
 hors piste 247  
 hors-bord *m* 215  
 hors-jeu *m* 223  
 hot-dog *m* 155  
 hôte *m* 64  
 hôtel *m* 100, 264  
 hôtesse *f* 64  
 hôtesse de l'air *f* 190, 210  
 hotte *f* 66  
 houé *f* 88  
 houppette *f* 40  
 houx *m* 296  
 hublot *m* 210, 214  
 huile *f* 142, 199  
 huile d'amande *f* 134  
 huile d'arachide *f* 135  
 huile d'olive *f* 134  
 huile de colza *f* 135  
 huile de maïs *f* 135  
 huile de noisette *f* 134  
 huile de noix *f* 134  
 huile de pépins de raisin *f* 134  
 huile de sésame *f* 134  
 huile de tournesol *f* 134  
 huile parfumée *f* 134  
 huile pressée à froid *f* 135  
 huile végétale *f* 135  
 huiles *f* 134  
 huiles essentielles *f* 55  
 huissier *m* 180  
 huit 308  
 huit cents 308  
 huitième 309  
 huître *m* 121  
 humérus *m* 17  
 humide 321, 286  
 hydravion *m* 211  
 hydroptère *m* 215  
 hydrothérapie *f* 55  
 hygiène dentaire *f* 72  
 hygiène féminine *f* 108  
 hypnothérapie *f* 55  
 hypoallergénique 41  
 hypoténuse *f* 164  
 hypothèque *f* 96
- I**  
 icône *f* 177  
 igname *f* 125  
 igné 288  
 iguane *m* 293  
 île *f* 282
- île Maurice 317  
 îles Galapagos 315  
 îles Malouines 315  
 îles Salomon 319  
 immeuble *m* 59, 298  
 immeuble de bureaux *m* 298  
 immigration *f* 212  
 immobilisation *f* 237  
 imperméable *m* 31, 32, 245, 267  
 impôt *m* 96  
 imprimante *f* 172, 176  
 imprimer 172  
 imprimerie *f* 275  
 impuissant 20  
 incendie *m* 95  
 incisive *f* 50  
 Inde 318  
 index *m* 15  
 individuelle 58  
 Indonésie 319  
 infection *f* 44  
 infirmier du SAMU *m* 94  
 infirmière *f* 45, 48, 52, 189  
 information *f* 261  
 information touristique *f* 261  
 infusion de menthe *f* 149  
 ingénieur du son *m* 179  
 inhalateur *m* 44, 109  
 injection *f* 48  
 innocent 181  
 inoculation *f* 45  
 inondation *f* 287  
 inox *m* 79  
 inquiet 25  
 insomnie *f* 71  
 inspecteur *m* 94  
 installer 177  
 institutrice *f* 162, 191  
 instruments *m* 256, 258  
 insuline *f* 109  
 intercostal *m* 16  
 interdit de tourner à droite 195  
 intérieur *m* 200  
 internet *m* 177  
 interphone *m* 59  
 interrupteur *m* 60  
 interrupteur feux *m* 201  
 interviewer *m* 179  
 intestin grêle *m* 18  
 invertébrés *m* 295  
 investissement *m* 97  
 invité *m* 64  
 ionosphère *f* 286  
 iPad *m* 176  
 iPod *m* 268  
 Irak 318  
 Iran 318  
 iris *m* 51, 110  
 Irlande 316  
 Islande 316  
 isolation *f* 61
- isorel *m* 79  
 Israël 318  
 Italie 316  
 itinéraire *m* 260
- J**  
 jacinthes des bois *f* 297  
 jade *m* 288  
 jais *m* 288  
 Jamaïque 314  
 jambe *f* 12  
 jambière *f* 224, 225  
 jambon *m* 119, 143, 156  
 jante *f* 206  
 janvier *m* 306  
 Japon 318  
 jardin *m* 84  
 jardin à la française *m* 84, 262  
 jardin d'eau *m* 84  
 jardin d'herbes aromatiques *m* 84  
 jardin paysan *m* 84  
 jardin sur le toit *m* 84  
 jardinage *m* 90  
 jardinier *m* 188  
 jarretelle *f* 35  
 jarretière *f* 35  
 jauge d'essence *f* 201  
 jauge d'huile *f* 202  
 jaune 274  
 jaune d'œuf *m* 137, 157  
 javelot *m* 234  
 jazz *m* 259  
 jean *m* 31, 33  
 jet *m* 89  
 jet d'eau *m* 95  
 jet privé *m* 211  
 jetable 109  
 jetée *f* 217  
 jeter l'ancre 217  
 jeton *m* 272  
 jet-ski *m* 241  
 jeu *m* 75, 230, 273  
 jeu de cartes *m* 273  
 jeu télévisé *m* 178  
 jeu vidéo *m* 269  
 jeudi *m* 306  
 jeux *m* 272  
 jeux de raquette *m* 231  
 jeux de société *m* 272  
 joaillerie *f* 275  
 jodhpur *m* 242  
 jogger sur place 251  
 jogging *m* 251, 263  
 joint *m* 61, 80  
 jointolement *m* 187  
 joker *m* 273  
 jonc *m* 86  
 jonquille *f* 111  
 Jordanie 318  
 joue *f* 14  
 jouer 229, 273  
 jouet *m* 75  
 jouet en peluche *m* 75  
 jouets *m* 105
- joueur *m* 221, 231, 273  
 joueur de basket *m* 226  
 joueur de cricket *m* 225  
 joueur de foot *m* 222  
 joueur de football *m* 220  
 joueuse de golf *f* 232  
 jour *m* 306  
 jour ouvrable *m* 306  
 journal *m* 112  
 journaliste *m* 190  
 judas *m* 59  
 judo *m* 236  
 juge *m* 180  
 juge de ligne *m* 220, 223, 230  
 juillet *m* 306  
 juin *m* 306  
 jumeaux *m* 23  
 jumelles *f* 281  
 jumping *m* 243  
 jupe *f* 30, 34  
 Jupiter *f* 280  
 jury *m* 180  
 jus *m* 127  
 jus d'ananas *m* 149  
 jus de fruit *m* 156  
 jus de pomme *m* 149  
 jus de raisin *m* 144  
 jus de tomate *m* 144, 149  
 jus d'orange *m* 148  
 jus et milk-shakes *m* 149  
 jusqu'à 320  
 juteux 127
- K**  
 kaki *m* 128  
 Kaliningrad 316  
 kangourou *m* 291  
 karaté *m* 236  
 Kazakhstan 318  
 kébab *m* 155  
 kendo *m* 236  
 Kenya 317  
 ketchup *m* 135, 154  
 kilomètre *m* 310  
 kinésithérapie *f* 49  
 kiosque *m* 215  
 kippers *m* 157  
 Kirghizistan 318  
 kiwi *m* 128  
 klaxon *m* 201, 204  
 kleenex *m* 108  
 knock-out *m* 237  
 koala *m* 291  
 Koweït 318  
 kumquat *m* 126  
 kung-fu *m* 236
- L**  
 laboratoire *m* 166  
 labourer 183  
 lac *m* 285  
 lacet *m* 37  
 lâcher 245

- lacrosse *m* 249  
 lactose *m* 137  
 laine *f* 277  
 laisser tremper 130  
 lait *m* 136, 156  
 lait condensé *m* 136  
 lait de brebis *m* 137  
 lait de chèvre *m* 136  
 lait de vache *m* 136  
 lait demi-écrémé *m* 136  
 lait écrémé *m* 136  
 lait en poudre *m* 137  
 lait entier *m* 136  
 laitue *f* 123  
 lame *f* 66, 78, 89  
 lame de rasoir *f* 73  
 lampadaire *m* 298  
 lampe *f* 50, 62  
 lampe de chevet *f* 70  
 lampe de radio *f* 45  
 lampe d'entrée *f* 58  
 lampe torche *f* 267  
 lancement *m* 281  
 lancement du poids *m* 234  
 lancer 221, 225, 227, 229, 245  
 lanceur *m* 225, 229, 281  
 landau *m* 75  
 langue *f* 19  
 langue de bœuf *f* 118  
 langues *f* 162  
 languette *f* 37  
 lanière *f* 207  
 Laos 318  
 lapin *m* 118, 290  
 laque *f* 38  
 large 321  
 largeur *f* 165  
 larme *f* 51  
 larynx *m* 19  
 latitude *f* 283  
 lavabo *m* 38, 72  
 lave *f* 283  
 lave-auto *m* 198  
 lave-glace *m* 199  
 lave-linge *m* 76  
 lave-linge séchant 76  
 laver 38, 77  
 laver à la brosse 77  
 laverie automatique *f* 115  
 lave-vaisselle *m* 66  
 laxatif *m* 109  
 le long de 320  
 Le Salvador 314  
 leçon *f* 163  
 lecteur cassettes *m* 269  
 lecteur CD *m* 268  
 lecteur DVD *m* 268  
 lecteur optique *m* 106  
 lecture *f* 269  
 léger 321  
 leggings 31  
 légumes *m* 107, 122, 124  
 légumes secs 130  
 lent 321  
 lentille de l'objectif *f* 167  
 lentilles *f* 131  
 lentilles de contact *f* 51  
 lentilles rouges *f* 131  
 Lesotho 317  
 Lettonie 316  
 lettre *f* 98  
 lettre par avion 98  
 levée *f* 98  
 lever 139  
 lever du soleil *m* 305  
 levier *m* 150  
 levier de frein *m* 207  
 levier de vitesse *m* 207  
 levier de vitesses *m* 201  
 lèvre *f* 14  
 lèvres *f* 20  
 levure *f* 138  
 lézard *m* 293  
 Liban 318  
 libellule *f* 295  
 Libéria 317  
 liberté conditionnelle *f* 181  
 librairie *f* 115  
 libre 321  
 Libye 317  
 licence *f* 169  
 licenciée *f* 169  
 licou *m* 243  
 Liechtenstein 316  
 ligament *m* 17  
 ligne *f* 244  
 ligne d'arrivée *f* 234  
 ligne de bout *f* 226  
 ligne de but *f* 220, 223, 224  
 ligne de centre *f* 226  
 ligne de côté *f* 230  
 ligne de départ *f* 234  
 ligne de fond *f* 230  
 ligne de jeu *f* 233  
 ligne de lancer franc *f* 226  
 ligne de pénalité *f* 229  
 ligne de service *f* 230  
 ligne de touche *f* 220, 221, 226  
 ligne de trois points *f* 226  
 ligne d'envoi *f* 225  
 ligne du ballon mort *f* 221  
 lignes *f* 165  
 limace *f* 295  
 limande-sole *f* 120  
 lime *f* 81  
 lime à ongles *f* 41  
 limitation de vitesse *f* 195  
 limite du terrain *f* 225  
 limonade *f* 144  
 limousine *f* 199  
 lin *m* 184, 277  
 linge *m* 76  
 linge de lit *m* 71  
 linge de maison *m* 105  
 linge propre *m* 76  
 linge sale *m* 76  
 lingerie *f* 35, 105  
 lingette *f* 74, 108  
 linteau *m* 186  
 lion *m* 291  
 liqueur *f* 145  
 liquide *m* 77  
 liquide amniotique *m* 52  
 lire 162  
 lis *m* 110  
 liseuse *f* 210  
 lit *m* 70  
 lit d'enfant *m* 74  
 lit de camp *m* 266  
 lit simple *m* 71  
 lit U.V. *m* 41  
 litchi *m* 128  
 literie *f* 74  
 litre *m* 311  
 littérature *f* 162, 169  
 Lituanie 316  
 livraison à domicile *f* 154  
 livre *f* 310  
 livre *m* 163, 168  
 lob *m* 230  
 locataire *m* 58  
 location de voitures *f* 213  
 locomotive *f* 208  
 loganberry *f* 127  
 loge *f* 254  
 logement du film *m* 270  
 logiciel *m* 176  
 logo *m* 31  
 loin de 320  
 lombaires *f* 17  
 long 34  
 longe *f* 121  
 longitude *f* 283  
 longueur *f* 165, 310  
 longueur d'ondes *f* 179  
 losange *m* 164  
 lotion *f* 109  
 lotion pour le corps *f* 73  
 lotion solaire *f* 265  
 lotte *f* 120  
 louche *f* 68  
 louer 58  
 loup *m* 290  
 lourd 286, 321  
 loutre *f* 290  
 louvoyer 241  
 loyer *m* 58  
 luffa *m* 73  
 luge *f* 247  
 lundi *m* 306  
 lune *f* 280  
 lunettes *f* 51, 247  
 lunettes de protection *f* 167  
 lunettes de sécurité *f* 81  
 lunettes de soleil *f* 51  
 lunettes protectrices *f* 238  
 lupins *m* 297  
 lutte *f* 236  
 Luxembourg 316  
 luzerne *f* 184  
 lymphatique 19  
**M**  
 macadam goudronné *m* 187  
 macadamia *f* 129  
 Macédoine 316  
 macéré 159  
 machine à coudre *f* 276  
 machine à couper *f* 139  
 machine à ramer *f* 250  
 machine de randonnée *f* 250  
 machine de rayons X *f* 212  
 machines *f* 187  
 mâchoire *f* 14  
 macis *m* 132  
 maçon *m* 186, 188  
 macramé *m* 277  
 Madagascar 317  
 Madame *f* 23  
 madeleine *f* 140  
 Mademoiselle *f* 23  
 magasin *m* 298  
 magasin à papier 172  
 magasin bio *m* 115  
 magasin d'antiquités *m* 114  
 magasin d'appareils photos *m* 115  
 magasin de chaussures *m* 114  
 magasin de disques *m* 115  
 magasin de meubles *m* 115  
 magasin de vins et spiritueux *m* 115  
 magazine *m* 112  
 magazines *m* 107  
 magma *m* 283  
 magnésium *m* 109  
 mai *m* 306  
 maillet *m* 275  
 maillon *m* 36  
 maillot *m* 222, 251  
 maillot de bain *m* 238, 265  
 maillot de rugby *m* 221  
 main *f* 13, 15  
 maintenant 304  
 mairie *f* 299  
 mais *m* 122, 124, 130, 184  
 maison *f* 58  
 maison de deux étages *f* 58  
 maison de poupée *f* 75  
 maison d'habitation *f* 182  
 maison pliante *f* 75  
 maître nageur *m* 239, 265  
 maîtrise *f* 169  
 majeur *m* 15  
 majorette *f* 220  
 mal de tête *m* 44  
 mal d'estomac *m* 44  
 malachite *f* 288  
 malade en consultation externe *m* 48  
 maladie *f* 44  
 maladie sexuellement transmissible *f* 20  
 Malaisie 318  
 Malawi 317  
 Maldives 318  
 Mali 317  
 Malte 316  
 mamelon *m* 12  
 mammifères *m* 290  
 manche *m* 34, 36, 187, 230, 258  
 manchego *m* 142  
 manchette *f* 32  
 mandarine *f* 126  
 mandat *m* 180  
 mandat postal *m* 98  
 mandrin *m* 78  
 manette *f* 61  
 manette de chauffage *f* 201  
 manette de secours *f* 209  
 manger 64  
 manger *m* 75  
 manger sur place 154  
 mangue *f* 128  
 manioc *m* 124  
 manivelle *f* 203  
 mannequin *m* 276  
 mante religieuse *f* 295  
 manteau *m* 32, 282  
 manucure *f* 41  
 manuel 200  
 maquereau *m* 120  
 maquette *f* 190  
 maquillage *m* 40  
 maracas *m* 257  
 marais *m* 285  
 marathon *m* 234  
 marbre *m* 288  
 marchand de hot-dogs *m* 154  
 marchand de journaux *m* 112  
 marchand de légumes *m* 114, 188  
 marchand d'occasion *m* 115  
 marchande de poissons *f* 188  
 marché *m* 115  
 mardi *m* 306  
 margarine *f* 137  
 marguerite *f* 110  
 mari *m* 22  
 mariage *m* 26, 35  
 marin *m* 189

- marina *f* 217  
 mariné 143, 159  
 marjolaine *f* 133  
 Maroc 317  
 marque *f* 273  
 marque de flottaison en charge *f* 214  
 marquer 227  
 marquer un but 223  
 marron 274  
 marron *m* 129  
 mars *m* 306  
 Mars *f* 280  
 marteau *m* 80  
 marteau de forgeron *m* 187  
 marteau de porte *m* 59  
 marteau-piqueur *m* 187  
 marteler 79  
 martini *m* 151  
 mascara *m* 40  
 masculin 21  
 masque *m* 189, 228, 236, 239, 249  
 masque de beauté *m* 41  
 masque protecteur *m* 225  
 massage *m* 54  
 mastic *m* 83  
 mastiquer 82  
 mat 83, 271  
 mât *m* 240, 266  
 match *m* 230  
 matelas *m* 70, 74  
 matelas à langer *m* 74  
 matelas pneumatique *m* 267  
 matériaux *m* 79, 187  
 matériel *m* 176  
 matériel de pêche *m* 245  
 maternité *f* 48, 49  
 mathématiques *f* 162, 164  
 matin *m*  
 matraque *f* 94  
 Mauritanie 317  
 mauvais 321  
 mauvais point *m* 228  
 mauvaises herbes *f* 86  
 maxillaire *m* 17  
 mayonnaise *f* 135  
 mécanicien *m* 188  
 mécanique *f* 202  
 mèche *f* 78  
 médailles *f* 235  
 médecin *m* 45  
 médecine *f* 169  
 médecine ayurvédique *f* 55  
 médias *m* 178  
 médicament *m* 109  
 médicament  
   multivitamine *m* 109  
 médicament pour  
   la toux *m* 108  
 médication *f* 109  
 méditation *f* 54  
 Méditerranée *f* 313  
 médium *m* 79  
 méduse *f* 295  
 mélanger 67, 138  
 mêlée *f* 221  
 mêlée ouverte *f* 221  
 mélèze *m* 296  
 mélodie *f* 259  
 melon *m* 127  
 mémoire *f* 176  
 menottes *f* 94  
 mensuel 307  
 menthe *f* 133  
 menton *m* 14  
 menu *m* 148  
 menu du déjeuner *m* 152  
 menu du soir *m* 152  
 menu enfant *m* 153  
 menuisier *m* 188  
 mer *f* 264, 282  
 mer Baltique *f* 313  
 mer Caspienne *f* 313  
 mer d'Arabie *f* 313  
 mer des Caraïbes *f* 312  
 mer du Nord *f* 312  
 mer Noire *f* 313  
 mer Rouge *f* 313  
 mercerie *f* 105  
 merci 322  
 mercredi *m* 306  
 mercure *m* 289  
 Mercure *f* 280  
 mère *f* 22  
 meringue *f* 140  
 merlan *m* 120  
 mésosphère *f* 286  
 message vocal *m* 99  
 messages *m* 100  
 mesure *f* 150, 151  
 mesure pour les liquides *f* 311  
 mesurer 310  
 mesures *f* 165  
 métacarpien *m* 17  
 métal *m* 79  
 métamorphique *m* 288  
 métatarsien *m* 17  
 métaux *m* 289  
 météore *m* 280  
 métier à tisser *m* 277  
 mètre *m* 80, 310  
 mètre carré *m* 310  
 métro *m* 209  
 mettre en scène *m* 254  
 mettre en pot 91  
 mettre la table 64  
 mettre le réveil 71  
 mettre un tuteur 91  
 meuble-classeur *m* 172  
 Mexique 314  
 mica *m* 289  
 micro *m* 258  
 micro-ondes *m* 66  
 microphone *m* 179  
 microscope *m* 167  
 midi *m* 305  
 miel liquide *m* 134  
 miel solide *m* 134  
 migraine *f* 44  
 mijoter 67  
 mile *m* 310  
 milk-shake *m* 137  
 milk-shake à la fraise *m* 149  
 milk-shake au chocolat *m* 149  
 mille 309  
 mille *m* 273  
 mille neuf cent dix 307  
 mille neuf cents 307  
 millénaire *m* 307  
 mille-pattes *m* 295  
 millet *m* 130  
 milliard *m* 309  
 milligramme *m* 310  
 millilitre *m* 311  
 millimètre *m* 310  
 million *m* 309  
 mince 321  
 minéraux *m* 289  
 minerve *f* 46  
 minibar *m* 101  
 minibus *m* 197  
 minijupe *f* 34  
 minuit *m* 305  
 minute *f* 304  
 miroir *m* 40, 71, 167  
 mise à la terre *f* 60  
 mise au point *f* 271  
 missile *m* 211  
 mi-temps *f* 223  
 mitoyenne 58  
 mitrailleuse *f* 189  
 mixeur *m* 66  
 mobile *m* 74  
 mocassin *m* 37  
 mode *f* 277  
 mode d'emploi *m* 109  
 modèle *m* 169  
 modèles *m* 199  
 modélisme *m* 275  
 module lunaire *m* 281  
 moineau *m* 292  
 moins 165  
 mois *m* 306  
 moisne *m* 74  
 moissonneuse-batteuse *f* 182  
 molaire *f* 50  
 Moldavie 316  
 mollet *m* 13, 16  
 Monaco 316  
 Mongolie 318  
 moniteur *m* 53, 75, 172,  
 Monopoly *m* 272  
 monorail *m* 208  
 Monsieur *m* 23  
 mont du lanceur *m* 228  
 montagne *f* 284  
 montagnes russes *f* 262  
 montant *m* 96  
 monter une tente 266  
 montgolfière *f* 211  
 montre *f* 36  
 monture *f* 51  
 monument *m* 261  
 monument historique *m* 261  
 morceaux de viande *m* 119  
 mordre 245  
 mors *m* 242  
 morse *m* 290  
 morsure *f* 46  
 mortier *m* 68, 167, 187  
 morue *f* 120  
 mosquée *f* 300  
 mot de passe *m* 99  
 moteur *m* 88, 202, 204  
 moto *f* 204  
 moto de course *f* 205  
 moto routière *f* 205  
 moto tout-terrain *f* 205  
 motocross *m* 249  
 motonautisme *m* 241  
 mou 129, 321  
 mouche *f* 244, 295  
 mouchoir *m* 36  
 mouette *f* 292  
 mouflon *m* 30  
 mouiller 217  
 moule *f* 121, 295  
 moule à gâteaux *f* 69  
 moule à muffins *m* 69  
 moule à soufflé *m* 69  
 moule à tarte *m* 69  
 moulinet *m* 244  
 moulure *f* 63  
 mourir 26  
 mousse *f* 141, 148  
 mousse à raser *f* 73  
 mousson *f* 287  
 moustiquaire *f* 267  
 moustique *m* 295  
 moutarde *f* 155  
 moutarde anglaise *f* 135  
 moutarde en grains *f* 135  
 moutarde française *f* 135  
 mouton *m* 185  
 moyeu *m* 206  
 Mozambique 317  
 mozzarella *f* 142  
 muffin *m* 140  
 multiplier 165  
 mur *m* 58, 186  
 mûr 129  
 mûre *f* 127  
 muscles *m* 16  
 musée *m* 261  
 musée d'art *m* 261  
 museronne *f* 242  
 musicien *m* 191  
 musique *f* 162  
 musique classique *f* 255, 259  
 musique folk *f* 259  
 myopie *f* 51  
 myrtille *f* 127

## N

- naan *m* 139  
 nacelle *f* 95  
 nage *f* 239  
 nage synchronisée *f* 239  
 nageoire 290  
 nageoire dorsale *f* 294  
 nageoire pectorale *f* 294  
 nager 238  
 nager sur place 239  
 nageur *m* 238  
 naissance *f* 52, 53  
 naître 26  
 Namibie 317  
 nappe *f* 64  
 narine *f* 14  
 natation *f* 238  
 nation *m* 315  
 natte *f* 39  
 naturel 118  
 naturopathie *f* 55  
 nausée *f* 44  
 navet *m* 124  
 navette *f* 197  
 navette spatiale *f* 281  
 navigateur *m* 177  
 navigateur satellite *m* 201  
 naviguer 177, 240  
 navire *m* 214  
 navire de guerre *m* 215  
 navire porte-conteneurs *m* 215  
 ne pas plier 98  
 nébuleuse *f* 280  
 nectarine *f* 126  
 négatif *m* 271  
 neige *f* 287  
 neige fondue *f* 286  
 néoclassique 301  
 Népal 318  
 Neptune *f* 280  
 nerf *m* 50, 19  
 nerf optique *m* 51  
 nerveux 19, 25  
 nettoyer 77  
 nettoyeur *m* 188  
 neuf 308, 321  
 neuf cents 308  
 neurologie *f* 49  
 neutre 60  
 neuvième 309  
 neveu *m* 23  
 nez *m* 14, 210  
 Nicaragua 314  
 nickel *m* 289  
 nièce *f* 23  
 Niger 317  
 Nigéria 317  
 niveau *m* 80



- niveau à bulle *m* 187  
 Noël *m* 27  
 nœud papillon *m* 36  
 noir 39, 272, 274  
 noir *m* 148  
 noisette *f* 129  
 noix *f* 129, 151  
 noix de cajou *f* 129, 151  
 noix de coco *f* 129  
 noix de muscade *f* 132  
 noix du Brésil *f* 129  
 noix et les fruits secs *f*, *m* 129  
 noix pacane *f* 129  
 nombres *m* 308  
 nombril *m* 12  
 non 322  
 non gazeux 144  
 non pasteurisés 137  
 non salé 137  
 nord *m* 312  
 normal 39  
 Norvège 316  
 notation *f* 256  
 note *f* 163, 256  
 notes *f* 191  
 nougat *m* 113  
 nouilles *f* 158  
 nourriture *f* 118, 130, 149  
 nourriture pour animaux *f* 107  
 nouveau-né *m* 53  
 Nouvel An *m* 27  
 nouvelle lune *f* 280  
 nouvelles *f* 178  
 Nouvelle-Zélande 319  
 novembre *m* 306  
 noyau extérieur *m* 282  
 noyau intérieur *m* 282  
 nuage *m* 287  
 nuageux 286  
 nuit *f* 305  
 numérateur *m* 165  
 numérique 179, 269  
 numéro *m* 226  
 numéro de bus *m* 196  
 numéro de chambre *m* 100  
 numéro de compte *m* 96  
 numéro de la porte d'embarquement *m* 213  
 numéro de voie *m* 208  
 numéro de vol *m* 213  
 nuque *f* 13  
 nylon *m* 277
- O**  
 O.R.L. *f* 49  
 objectif *m* 270  
 objet exposé *m* 261  
 observation des oiseaux *f* 263  
 obsidienne *f* 288  
 obstacle *m* 243
- obstacle d'eau *m* 232  
 obstétricien *m* 52  
 obtenir sa licence 26  
 occupé 99  
 océan *m* 282  
 océan Arctique *m* 312  
 océan Atlantique *m* 312  
 océan Austral *m* 313  
 océan Indien *m* 312  
 océan Pacifique *m* 312  
 octobre *m* 306  
 octogone *m* 164  
 oculaire *m* 167  
 odomètre *m* 201  
 œil *m* 14, 51  
 œillet *m* 37, 110, 244, 276  
 œilleton *m* 269  
 œsophage *m* 19  
 œuf à la coque *m* 137, 157  
 œuf de caille *m* 137  
 œuf de cane *m* 137  
 œuf de poule *m* 137  
 œuf d'oie *m* 137  
 œuf sur le plat *m* 157  
 œufs *m* 137  
 œufs brouillés *m* 157  
 officier de police *m* 94  
 officine *f* 108  
 oie *f* 119, 293  
 oignon *m* 124  
 oiseaux *m* 292  
 okra *m* 122  
 olive fourrée *f* 143  
 olive noire *f* 143  
 olive verte *f* 143  
 olives *f* 151  
 Oman 318  
 omelette *f* 158  
 omoplate *f* 17  
 once *f* 310  
 oncle *m* 22  
 oncologie *f* 49  
 ondes courtes *f* 179  
 ondes moyennes *f* 179  
 ongle *m* 15  
 ongle du pied *m* 15  
 onyx *m* 289  
 onze 308  
 onzième 309  
 opale *f* 288  
 opéra *m* 255  
 opération *f* 48  
 ophtalmologie *f* 49  
 opticien *m* 51, 189  
 or *m* 235, 289  
 orage *m* 287  
 orange 274  
 orange *f* 126  
 orangeade *f* 144  
 orbite *f* 280  
 orchestre *m* 254, 256  
 orchidée *f* 111  
 ordinateur *m* 176  
 ordonnance *f* 45
- ordre du jour *m* 174  
 oreille *f* 14  
 oreiller *m* 70  
 oreillons *m* 44  
 organes de reproduction *m* 20  
 organes génitaux 12  
 orge *f* 130, 184  
 orientation d'un patient *m* 49  
 origami *m* 275  
 origan *m* 133  
 orme *m* 296  
 ornemental 87  
 ornements de jardin *m* 84  
 ortel *m* 15  
 orthopédie *f* 49  
 ortie *f* 297  
 os *m* 17, 119  
 oseille *f* 123  
 ostéopathie *f* 54  
 otarie *f* 290  
 ouatage *m* 277  
 ouest *m* 312  
 Ouganda *m* 317  
 oui 322  
 ouïe *f* 294  
 ouragan *m* 287  
 ourlet *m* 34  
 ours *m* 291  
 ours blanc *m* 291  
 ours en peluche *m* 75  
 outils *m* 187  
 outils de jardin *m* 88  
 ouvert 260, 321  
 ouverture *f* 256  
 ouvrages recommandés *m* 168  
 ouvre-boîte *m* 68  
 ouvre-bouteille *m* 68, 150  
 Ouzbékistan 318  
 ovaire *m* 20  
 ovale *m* 164  
 over par *m* 233  
 ovulation *f* 20, 52  
 ovule *m* 20
- P**  
 P.C.V. *m* 99  
 pagaie *f* 241  
 paie *f* 175  
 paiement *m* 96  
 paillason *m* 59  
 paille *f* 144, 154  
 paille de fer *f* 81  
 pailler 91  
 pain *m* 139, 157, 311  
 pain au bicarbonate de soude *m* 139  
 pain au levain *m* 139  
 pain aux graines *m* 139  
 pain aux raisins secs *m* 139  
 pain bis *m* 139, 149
- pain blanc *m* 139  
 pain complet *m* 139  
 pain de maïs *m* 139  
 pain de seigle *m* 138  
 pain de son *m* 139  
 pain perdu *m* 157  
 pain plat *m* 139  
 pain tranché *m* 138  
 pains *m* 138  
 Pakistan 318  
 palais *m* 19  
 pale de rotor *f* 211  
 palet *m* 224  
 palette *f* 186, 274  
 palier *m* 59  
 palisser 91  
 palme *f* 239  
 palmier *m* 86, 296  
 pamplemousse *m* 126  
 panais *m* 125  
 Panama 314  
 pancréas *m* 18  
 panda *m* 291  
 panier *m* 106, 207, 226  
 panier à jouets *m* 75  
 panier à linge *m* 76  
 panier à pique-nique *m* 263  
 panier de jardinier *m* 88  
 panier de pêche *m* 245  
 panier suspendu *m* 84  
 panne *f* 195, 203  
 panneau *m* 226  
 panneau d'affichage 173  
 panneau de signalisation *m* 298  
 panneaux routiers *m* 195  
 pansement *m* 47  
 pantalon *m* 32, 34  
 pantalon de jogging *m* 33  
 pantoufles *f* 31  
 paon *m* 293  
 papaye *f* 128  
 papeterie *f* 105  
 papier cache *m* 83  
 papier d'apprêt *m* 83  
 papier de verre *m* 81, 83  
 papier filtre *m* 167  
 papier gaufré *m* 83  
 papier mâché *m* 275  
 papier peint *m* 82, 177  
 papillon *m* 239, 295  
 Papouasie-Nouvelle-Guinée 319  
 paprika *m* 132  
 Pâques *f* 27  
 paquebot *m* 215  
 pâquerette *f* 297  
 Pâques *f* 27  
 paquet *m* 311  
 paquet de cigarettes *m* 112  
 par *m* 233  
 par avion 98  
 parachute *m* 248
- parachutisme *m* 248  
 Paraguay 315  
 parallèle 165  
 parallélogramme *m* 164  
 parapente *m* 248  
 parapluie *m* 36, 233  
 parasol *m* 264  
 parc *m* 75, 261, 262  
 parc d'attractions *m* 262  
 parc national *m* 261  
 parcourmètre *m* 195  
 parcours de golf *m* 232  
 pare-brise *m* 198, 205  
 pare-chocs *m* 198  
 parents *m* 23  
 pare-vent *m* 265  
 pardon 322  
 parfum *m* 41  
 parfumé 130  
 parfumerie *f* 105  
 pari *m* 273  
 parking *m* 298  
 parking réservé aux personnes handicapées *m* 195  
 parmesan *m* 142  
 paroles *f* 259  
 partenaire *m*, *f* 23  
 parterre *m* 85, 90  
 partir du tee 233  
 partition *f* 255, 256  
 pas *m* 243  
 passage clouté *m* 195  
 passage inférieur *m* 194  
 passager *m* 216  
 passe *f* 226  
 passeport *m* 213  
 passerelle *f* 212, 214  
 passoire *f* 68  
 pastels *m* 274  
 pastèque *f* 127  
 pasteurisés 137  
 pastille pour la gorge *f* 109  
 patate douce *f* 125  
 pataugas *m* 37  
 pataugeoire *f* 263  
 patchwork *m* 277  
 pâte *f* 138, 140  
 pâté *m* 142, 156  
 pâte à choux *f* 140  
 pâte à tartiner au chocolat *f* 135  
 pâte à tartiner au citron *f* 134  
 pâte d'amandes *f* 141  
 pâte de filo *f* 140  
 pâte feuilletée *f* 140  
 pâtes *f* 158  
 pâtes en croûte *m* 143  
 pathologie *f* 49  
 patient *m* 45  
 patin à glace *m* 224, 247  
 patin de frein *m* 207  
 patin en ligne *m* 249

- patinage *m* 247  
 patinage artistique *m* 247  
 patinage de vitesse *m* 247  
 patiner 224  
 patinoire *f* 224  
 patio *m* 85  
 pâtisserie *f* 69, 114, 149  
 patron *m* 276  
 paume *f* 15  
 paupière *f* 51  
 pause *f* 269  
 pavé *m* 85  
 pavillon *m* 58, 232  
 payer 153  
 pays *m* 315  
 paysage *m* 284  
 paysage 271  
 Pays-Bas 316  
 peau *f* 14, 119, 128  
 peau blanche *f* 126  
 pêche *f* 126, 128, 244  
 pêche à la mouche *f* 245  
 pêche au lancer en mer *f* 245  
 pêche en eau douce *f* 245  
 pêche hauturière *f* 245  
 pêche maritime *f* 245  
 pêche sous-marine *f* 245  
 pêche sportive *f* 245  
 pêcheur *m* 189, 244  
 pectoral *m* 16  
 pédale *f* 61, 206, 257  
 pédale de frein *f* 205  
 pédaler 207  
 pédiatrie *f* 48, 49  
 pédicurie *f* 41  
 peigne *m* 38  
 peigner 38  
 peignoir *m* 32, 35, 38, 73  
 peindre 83  
 peintre *m* 191  
 peinture *f* 83, 274  
 peintures à l'huile *f pl* 274  
 peinture mate *f* 83  
 pélican *m* 292  
 pelle *f* 77, 187, 265  
 pelle à poisson *f* 68  
 pelle mécanique *f* 187  
 pellicule *f* 260, 271  
 pellicules *f* 39  
 pelote à épingles *f* 276  
 pelouse *f* 85, 90, 262  
 penalty *m* 222  
 pendentif *m* 36  
 péninsule *f* 282  
 pénis *m* 21  
 pension complète *f* 101  
 pentagone *m* 164  
 pente de ski *f* 246  
 pépin *m* 128, 127  
 pépinière *f* 115  
 pepperoni *m* 142  
 percer 79  
 perceuse électrique *f* 7  
 perceuse manuelle *f* 81  
 perceuse rechargeable *f* 78  
 perche *f* 179, 245  
 percolateur *m* 148, 150  
 percussion *f* 257  
 perdant *m* 273  
 perdre 273  
 perdre les eaux 52  
 père *m* 22  
 perforateur 173  
 perfusion *f* 53  
 pergola *f* 84  
 périodique *f* 52  
 périodique *m* 168  
 permanente *f* 39  
 permis de pêche *m* 245  
 péroné *f* 17  
 Pérou 315  
 perpendiculaire 165  
 perroquet *m* 293  
 perruque *f* 39  
 persil *m* 133  
 personnel *m* 175  
 pesanteur *f* 280  
 pése-bébé *m* 53  
 peser 310  
 pesticide *m* 89, 183  
 pétale *m* 297  
 petit 321  
 petit ami *m* 24  
 petit bassin *m* 239  
 petit déjeuner *m* 64, 156  
 petit déjeuner anglais *m* 156  
 petit enfant *m* 30  
 petit galop *m* 243  
 petit gâteau *m* 140  
 petit orteil *m* 15  
 petit pain *m* 139, 143, 155  
 petit pain américain *m* 139  
 petit pain rond *m* 139  
 petit pois *m* 122  
 petite aiguille *f* 304  
 petite amie *f* 24  
 petite fourche *f* 89  
 petite-fille *f* 22  
 petit-fils *m* 22  
 petits pois *m* 131  
 petits-enfants *m* 23  
 pétrir 138  
 pétrolier *m* 215  
 peuplier *m* 296  
 peut-être 322  
 phare *m* 198, 205, 207, 217  
 pharmacien *m* 108  
 pharmacienne *f* 189  
 pharynx *m* 19  
 philatélie *f* 273  
 Philippines 319  
 philosophie *f* 169  
 photo *f* 290  
 photo *f* 271  
 photocopier 172  
 photo-finish *m* 234  
 photographe *m* 191  
 photographie *f* 270  
 photographe 271  
 photophone *m* 270  
 physalis *f* 128  
 physique *f* 162, 169  
 piano *m* 256  
 piano électronique *m* 258  
 pic *m* 292  
 piccolo *m* 257  
 pichet *m* 151  
 pick-up *m* 258  
 pièce *f* 97, 272  
 pièce jointe *f* 177  
 pièce de théâtre *f* 254  
 pièces rendues *f pl* 99  
 pied *m* 12, 15, 310  
 pied carré *m* 310  
 pied du lit *m* 71  
 pierre *f* 36, 275  
 pierre à aiguiser *f* 81  
 pierre de lune *f* 288  
 pierre ponce *f* 73, 288  
 pieuvre *f* 121, 295  
 pigeon *m* 292  
 pignon *m* 129, 207, 300  
 Pilates *m* 251  
 pile *f* 78, 167  
 piles *f* 260  
 pillule *f* 109  
 pilon *m* 68, 167  
 pilote *m* 190, 211  
 pilule *f* 21  
 piment *m* 124, 132, 143  
 pin *m* 296  
 pince *f* 166, 167  
 pince à cheveux *f* 38  
 pince à dénuder *f* 81  
 pince à dessin 173  
 pince à épiler *f* 40  
 pince à linge *f* 76  
 pince coupante *f* 80  
 pince crocodile *f* 167  
 pince fine *f* 47, 167  
 pince plate *f* 80  
 pince pour le nez *f* 238  
 pince universelle *f* 80  
 pinceau *m* 40, 274  
 pinceau à lèvres *m* 40  
 pinceau à pâtisserie *m* 69  
 pinces *f* 150  
 pingouin *m* 292  
 pinte *f* 311  
 pioche *f* 187  
 pion *m* 272  
 pipe *f* 112  
 pipette *f* 167  
 pique *m* 273  
 pique-nique *m* 263  
 piquer 90  
 piquet *m* 225, 266  
 piqûre *f* 46  
 piscine *f* 101, 238, 250  
 pissenlit *m* 123, 297  
 pistache *f* 129  
 piste *f* 212, 234  
 piste cavalière *f* 263  
 piste cyclable *f* 206  
 piste de ski *f* 246  
 pistolet *m* 94  
 pistolet à colle *m* 78  
 pita *m* 139  
 pivoine *f* 111  
 pizza *f* 154  
 pizzeria *f* 154  
 placard *m* 66  
 place *f* 299  
 placenta *m* 52  
 places *f* 254  
 placeur *m* 255  
 plafond *m* 62  
 plage *f* 264  
 plaidoyer *m* 180  
 plaine *f* 285  
 plainte *f* 94  
 plan *m* 261  
 plan de métro *m* 209  
 plan de travail *m* 66  
 planche *f* 238, 241  
 planche à hacher *f* 68  
 planche à repasser *f* 76  
 planche à roulette *f* 249, 263  
 planche à voile *f* 241  
 planches *f* 85  
 planchiste *m* 241  
 planète *f* 280, 282  
 planeur *m* 211, 248  
 plante à fleurs *f* 297  
 plante alpestre *f* 87  
 plante aquatique *f* 86  
 plante d'ombre *f* 87  
 plante du pied *f* 15  
 plante en pot *f* 87, 110  
 plante grasse *f* 87  
 plante grimpeuse *f* 87  
 plante rampante *f* 87  
 planter 183  
 plantes *f* 296  
 plantes de jardin *f* 86  
 plaque *f* 50, 283  
 plaque à gâteaux *f* 69  
 plaque d'immatriculation *f* 198  
 plat à gratin *m* 69  
 plat à rôtir *m* 69  
 plat principal *m* 153  
 plateau *m* 152, 154, 178, 284, 310  
 plateau de desserts *m* 152  
 plateau à petit déjeuner *m* 101  
 platine *m* 289  
 platine *f* 167, 276  
 platine magnétophone *f* 268  
 plâtre *m* 83  
 plâtrer 82  
 plats *m* 153  
 plats cuisinés *m* 107  
 plein 321  
 pleine lune *f* 280  
 pleurer 25  
 plomb *m* 244  
 plombage *m* 50  
 plomberie *f* 61  
 plombier *m* 188  
 plongée *f* 239  
 plongeur *m* 239  
 plongeur de haut vol *m* 239  
 plonger 238  
 plongeur *m* 238  
 plot de départ *m* 238  
 pluie *f* 287  
 plume *f* 163, 293  
 plus 165  
 plus tard 304  
 Pluton *m* 280  
 pneu *m* 198, 205, 206  
 poche *f* 32, 293  
 pocher 67  
 pochoir *m* 83  
 podium *m* 235, 256  
 poêle *f* 69  
 poids *m* 166, 250  
 poids de naissance *m* 53  
 poignée *f* 196, 200  
 poignées *f* 37  
 poignet *m* 13, 15, 230  
 poing *m* 15, 237  
 point *m* 228, 273, 277  
 pointe *f* 37, 122, 246  
 pointes *f* 233  
 points de suture *m* 52  
 poire *f* 127  
 poireau *m* 125  
 pois *m* 131  
 pois cassés *m* 131  
 pois chiches *m* 131  
 poisson *m* 107, 120  
 poisson avec des frites *m* 155  
 poisson fumé 143  
 poisson rouge *m* 294  
 poissonnerie *f* 114, 120  
 poissons *m* 294  
 poitrine *f* 12  
 poivre *m* 64, 152  
 poivre de la Jamaïque *f* 132  
 poivron *m* 124  
 poker *m* 273  
 Polaroid *m* 270  
 pôle *m* 282  
 pôle nord *m* 283  
 police *f* 94, 177  
 policier *m* 94, 189  
 polo *m* 243  
 Pologne 316  
 polyester *m* 277

- pommade *f* 47, 109  
 pomme *f* 126  
 pomme d'Adam *f* 19  
 pomme de terre *f* 124  
 pomme de terre nouvelle *f* 124  
 pommeau *m* 242  
 pommeau de douche *m* 72  
 pommes *f* 89  
 pompe *f* 199, 207  
 pompe à bière *f* 150  
 pompe à lait *f* 53  
 pompier *m* 189  
 pompiers *m* 95  
 poncer 82  
 ponceuse *f* 78  
 pont *m* 214, 300  
 pont arrière *m* 214  
 pont de commandement *m* 214  
 pont de côté *m* 240  
 pop *f* 259  
 pop-corn *m* 255  
 porc *m* 118  
 porcelaine *f* 105  
 porcelet *m* 185  
 porche *m* 58  
 porcherie *f* 185  
 pore *m* 15  
 porridge *m* 157  
 port *m* 176, 214, 216, 217  
 port de conteneurs *m* 216  
 port de passagers *m* 216  
 port de pêche *m* 217  
 portable *m* 172, 175  
 portable *m* 99, 176  
 portail *m* 85  
 porte *f* 196, 198, 209, 247  
 porte automatique *f* 196  
 porte d'entrée *f* 58  
 porte de douche *f* 72  
 porte vitrée *f* 59  
 porte-avions *m* 215  
 porte-bagages *m* 204, 209, 212  
 porte-bébé *m* 75  
 porte-crayons 172  
 porte-dossiers 173  
 portée *f* 256  
 portefeuille *m* 37, 97  
 porte-fusibles *m* 203  
 porte-monnaie *m* 37  
 porte-objet *m* 167  
 porte-outils *m* 78  
 porte-parapluies *m* 59  
 porte-savon *m* 73  
 porte-serviettes *m* 72  
 porteur *m* 100  
 portillon *m* 209  
 portion *f* 64  
 porto *m* 145  
 Porto Rico 314  
 portrait 271  
 portrait-robot *m* 181  
 Portugal 316  
 pose *f* 271  
 posemètre *m* 270  
 poser 82  
 position *f* 232  
 posologie *f* 109  
 poste *f* 98  
 poste de péage *m* 194  
 poste de police *m* 94  
 postier *m* 98  
 pot *m* 65, 74, 134, 311  
 pot à fleurs *m* 89  
 pot d'échappement *m* 204  
 pot de peinture *m* 83  
 pot d'échappement *m* 203  
 potage *m* 158  
 potager *m* 85, 182  
 poteau *m* 220, 222  
 poterie *f* 275  
 pot-pourri *m* 111  
 poubelle *f* 61, 67, 177  
 pouce *m* 15, 310  
 poudre *f* 40, 77, 109  
 poudre de curry *f* 132  
 poudrier *m* 40  
 poulailler *m* 185  
 poulain *m* 185  
 poulet *m* 119, 185  
 poulet frit *m* 155  
 poulet préparé *m* 119  
 pouls *m* 47  
 poumon *m* 18  
 poupée *f* 75  
 pour 320  
 pourcentage *m* 165  
 pourri 127  
 poussette *f* 75  
 poussin *m* 185  
 poutre *f* 186, 235  
 prairie *f* 285  
 pré *m* 182, 285  
 prélèvement *m* 96  
 prématuré 52  
 premier 309  
 premier étage *m* 104  
 première *f* 254  
 premiers secours *m* 47  
 prémolaire *f* 50  
 prénatal 52  
 prendre au filet 245  
 prendre des notes 163  
 prendre la mer 217  
 prendre sa retraite 26  
 prendre un bain 72  
 prendre un bain de soleil 264  
 prendre une douche 72  
 préparation *f* 159  
 préparé 121  
 prépuce *m* 21  
 près de 320  
 presbytie *f* 51  
 présentateur *m* 178  
 présentation *f* 174  
 présentatrice *f* 179, 191  
 présider 174  
 presse-ail *m* 68  
 presse-pied *m* 276  
 presse-purée *m* 68  
 pressing *m* 115  
 pression des pneus *f* 203  
 prêt *m* 96, 168  
 preuve *f* 181  
 prie 321  
 primevère *f* 297  
 principauté *f* 315  
 printemps *m* 307  
 prise *f* 60, 237  
 prise de courant *f* 60  
 prise maladroite du ballon *f* 220  
 prison *f* 181  
 prix *m* 152, 209  
 prix d'entrée *m* 260  
 prix des actions *m* 97  
 prix du ticket *m* 197  
 problèmes *m* 271  
 produit anti-insecte *m* 108  
 produits à tartiner *m* 134  
 produits d'entretien *m* 107  
 produits laitiers *m* 136  
 produits surgelés *m* 107  
 professions *f* 188, 190  
 profondeur *f* 165  
 programmation *f* 178  
 programme *m* 176, 254  
 projecteur *m* 259  
 projecteur numérique *m* 163  
 projection *f* 237  
 prolongation *f* 223  
 promenade *f* 265  
 promotions *f* 106  
 propager 91  
 proposition *f* 174  
 propriétaire *m* 58  
 prosciutto *m* 143  
 prostate *f* 21  
 protections *f* 220  
 protège-barreaux *m* 74  
 protège-dents *m* 237  
 protège-slip *m* 108  
 protège-tête *m* 236  
 proue *f* 215  
 province *f* 315  
 provisions *f* 106  
 prune *f* 126  
 pruneau *m* 129  
 psychiatrie *f* 49  
 psychothérapie *f* 55  
 public *m* 254  
 publicité *f* 269  
 pullover *m* 33  
 pulpe *f* 124, 127  
 pulvérisateur *m* 311  
 punaise 173  
 punching-bag *m* 237  
 pupille *f* 51  
 pupitre *m* 162  
 pupitre de mixage *m* 179  
 putter 233  
 putter *m* 233  
 puzzle *m* 273  
 pyjama *m* 30, 33  
 pyramide *f* 164  
**Q**  
 Qatar 318  
 quadriceps *m* 16  
 quai *m* 208, 216  
 quarante 308  
 quarante minutes 304  
 quarantième 309  
 quart d'heure 304  
 quartier *m* 126  
 quartz *m* 289  
 quatorze 308  
 quatorzième 309  
 quatre 308  
 quatre cents 308  
 quatre-quatre *f* 199  
 quatre-vingts 308  
 quatre-vingt-dix 308  
 quatre-vingt-dixième 309  
 quatre-vingtième 309  
 quatrième 309  
 question *f* 163  
 questionner 163  
 queue *f* 121, 210, 242, 280, 290, 294  
 queue de cheval *f* 39  
 quiche *f* 142  
 quille *f* 214, 249  
 quincallerie *f* 114  
 quinoa *m* 130  
 quinze 308  
 quinze jours 307  
 quinzième 309  
**R**  
 rabot *m* 81  
 raboter 79  
 racine *f* 50, 124, 296  
 racines *f* 39  
 racler 77  
 racquetball *m* 231  
 radar *m* 214, 281  
 radeau de sauvetage *m* 240  
 radiateur *m* 60, 202  
 radiccio *m* 123  
 radio *f* 48, 50, 179, 268  
 radio dentaire *f* 50  
 radiologie *f* 49  
 radio numérique *m* 268  
 radio-réveil *m* 70  
 radis *m* 124  
 radius *m* 17  
 rafraîchir 39  
 rafting *m* 241  
 rage de dents *f* 50  
 ragoût *m* 158  
 raide 39  
 raie *f* 120, 294  
 raifort *m* 125  
 rail *m* 208  
 rail conducteur *m* 209  
 raisin de Corinthe *m* 129  
 raisin de Smyrne *m* 129  
 raisin sec *m* 129  
 rallonge *f* 78  
 rallye *m* 249  
 RAM *f* 176  
 ramadan *m* 26  
 ramasseur de balles *m* 231  
 rambarde *f* 59  
 rame *f* 241  
 ramener 245  
 ramequin *m* 69  
 ramer 241  
 rameur *m* 241  
 rampe *f* 59  
 rampe de lancement *f* 281  
 ramure *f* 291  
 randonnée *f* 243, 263  
 rang de perles *m* 36  
 rangée *f* 210, 254  
 rap *m* 259  
 râpe *f* 68  
 râper 67  
 rapide 321  
 rapide *m* 209  
 rapides *m* 240, 284  
 rappel *m* 248  
 rapport *m* 174  
 rapporteur *m* 165  
 rapports sexuels *m* 20  
 raquette *f* 230, 231  
 rasage *m* 73  
 rasoir électrique *m* 73  
 rasoir jetable *m* 73  
 rassasié 64  
 rat *m* 290  
 rate *f* 18  
 râteau *m* 88  
 ratisser 90  
 raton laveur *m* 290  
 rayon *m* 164, 207  
 rayon bagages *m* 104  
 rayon chaussures *m* 104  
 rayon enfants *m* 104  
 rayons *m* 168  
 rayons ultraviolets *m* 286  
 réacteur *m* 210  
 réanimation *f* 47  
 rebond *m* 227  
 réception *f* 100  
 réceptionniste *f* 100, 190  
 recevoir *m* 229  
 recevoir 177  
 réchaud *m* 269  
 réchauffer 154  
 recherche *f* 169  
 récif de corail *m* 285

- récipient *m* 311  
 récipient Petri *m* 166  
 récolter 91, 183  
 record *m* 234  
 record personnel *m* 234  
 rectangle *m* 164  
 rectum *m* 21  
 reçu *m* 152  
 rédaction *f* 163  
 rédactrice *f* 191  
 redressement assis *m* 251  
 réduire 172  
 réflecteur *m* 204  
 reflets *m* 39  
 réflexologie *f* 54  
 réfrigérateur *m* 67  
 réfrigérateur-congélateur *m* 67  
 refroidissement *m* 44  
 regarder la télévision 269  
 reggae *m* 259  
 région *f* 315  
 registre *m* 100  
 réglage de l'allumage *m* 203  
 règle *f* 163, 165  
 régler 179  
 régler la radio 269  
 règles *f* 20  
 réglisse *m* 113  
 régulateur *m* 239  
 reiki *f* 55  
 rein *m* 18  
 relais *m* 235  
 relations *f* 24  
 relaxation *f* 55  
 remorque *f* 266  
 remorquer 195  
 remorqueur *m* 215  
 remplaçant *m* 223  
 remplacement *m* 223  
 remuer 67  
 Renaissance 301  
 renard *m* 290  
 rendez-vous *m* 45, 175  
 rênes *f* 242  
 renoncule *f* 297  
 renouveler 168  
 renseignements *m* 99, 168  
 rentrée en touche *f* 223, 226  
 renvoyé 48  
 repas *m* 64, 158  
 repas de noces *m* 26  
 repasser 76  
 répondeur *m* 99  
 répondre 163  
 réponse *f* 163  
 reporter *f* 179  
 repose-tête *m* 200  
 repriser 277  
 reproducteur 19  
 reproduction *f* 20  
 reptiles *m* 293  
 République centrafricaine 317  
 République démocratique du Congo 317  
 République dominicaine 314  
 République tchèque 316  
 requin *m* 294  
 réseau *m* 176  
 réseau d'électricité *m* 60  
 réseau ferroviaire *m* 209  
 réserve *f* 262  
 réserver 168  
 réservoir *m* 61  
 réservoir d'huile *m* 204  
 réservoir de lave-glace *m* 202  
 réservoir de liquide de freins *m* 202  
 réservoir de liquide de refroidissement *m* 202  
 réservoir d'essence *m* 203, 204  
 résidence universitaire *f* 168  
 résistance *f* 61  
 respiration *f* 47  
 respiratoire 19  
 ressort *m* 71  
 restaurant *m* 101, 152  
 restaurant rapide *m* 154  
 restaurant universitaire 168  
 restauration rapide *f* 154  
 résultat *m* 49  
 retard *m* 309  
 rétiné *f* 51  
 retour *m* 231  
 retour rapide *m* 269  
 retourner 91  
 retrait des bagages 213  
 rétroviseur *m* 198  
 réunion *f* 174  
 réveil *m* 70  
 revers *m* 32, 231  
 revêtement *m* 66, 187  
 revue *f* 168  
 rez-de-chaussée *m* 104  
 rhinocéros *m* 291  
 rhombe *m* 164  
 rhubarbe *f* 127  
 rhum *m* 145  
 rhum coca *m* 151  
 rhume *m* 44  
 rhume des foies *m* 44  
 richelieu *m* 37  
 ride *f* 15  
 rideau *m* 63, 254  
 rideau de douche *m* 72  
 rincer 38, 76  
 ring *m* 237  
 rire 25  
 rive *f* 284  
 rivière *f* 284  
 riz *m* 130, 158, 184  
 riz à grains ronds *m* 130  
 riz blanc *m* 130  
 riz complet *m* 130  
 riz sauvage *m* 130  
 robe *f* 31, 34, 169  
 robe de chambre *f* 31  
 robe de mariée *f* 35  
 robe du soir *f* 34  
 robinet *m* 61, 66  
 robinet d'eau chaude *m* 72  
 robinet d'eau froide *m* 72  
 robinet de purge *m* 61  
 robinet de sectionnement *m* 61  
 robot ménager *m* 66  
 rocaille *f* 84  
 rochers *m* 284  
 roches *f* 288  
 Rocheuses *f* 312  
 rococo 301  
 rodéo *m* 243  
 rognon *m* 119  
 roi *m* 272, 273  
 roller *m* 263  
 romarin *m* 133  
 rond de serviette *m* 65  
 rond-point *m* 195  
 ronfler 71  
 roquette *f* 123  
 rose 274  
 rose *f* 110  
 rosé 145  
 rôti *m* 158  
 rôti 67  
 rotule *f* 17  
 roue *f* 198, 207  
 roue arrière *f* 197  
 roue avant *f* 196  
 roue de nez *f* 210  
 roue de secours *f* 203  
 roue dentée *f* 206  
 roues d'entraînement *f* 207  
 rouge 145, 274  
 rouge à lèvres *m* 40  
 rougeole *f* 44  
 rouget barbet *m* 120  
 rough *m* 232  
 rouleau *m* 39, 83, 311  
 rouleau compresseur *m* 187  
 rouleau de papier hygiénique *m* 72  
 rouleau de pellicule *m* 271  
 rouleau à pâtisserie *m* 69  
 Roumanie 316  
 round *m* 237  
 route à quatre voies *f* 195  
 route d'accès *f* 216  
 routes *f* 194  
 roux 39  
 Royaume-Uni *m* 316  
 ruban *m* 27, 39, 111, 141  
 ruban isolant *m* 81  
 rubis *m* 288  
 rue *f* 298  
 rue transversale *f* 299  
 ruelle *f* 298  
 rugby *m* 221  
 ruine célèbre *f* 261  
 ruisseau *m* 285  
 rumsteck *m* 119  
 runabout *m* 214  
 rustine *f* 207  
 rutabaga *m* 125  
 Rwanda 317  
**S**  
 sable *m* 85, 264  
 sabot *m* 291  
 sabot *m* 242  
 sabre *m* 236  
 sac *m* 75, 311  
 sac à bandoulière *m* 37  
 sac à dos *m* 31, 37, 267  
 sac à herbe *m* 88  
 sac à main *m* 37  
 sac à provisions *m* 106  
 sac d'appareil photo *m* 271  
 sac de couchage *m* 267  
 sac de golf *m* 233  
 sac de plage *m* 264  
 sac en plastique *m* 122  
 sac postal *m* 98, 190  
 sachet de thé *m* 144  
 sacs *m* 37  
 safran *m* 132  
 sage-femme *f* 53  
 Sahara *m* 313  
 Sahara occidental *m* 317  
 saignement de nez *m* 44  
 Sainte-Lucie 314  
 Saint-Kitts-et-Nevis 314  
 Saint-Marin 316  
 Saint-Vincent-et-les-Grenadines 314  
 saisons *f* 306  
 salade *f* 149  
 salade composée *f* 158  
 salade verte *f* 158  
 salaire *m* 175  
 salamandre *f* 294  
 salami *m* 142  
 salé 118, 121, 129, 137, 143, 155  
 salle *f* 48  
 salle à manger *f* 64  
 salle d'opération *f* 48  
 salle d'attente *f* 45  
 salle de bain *f* 72  
 salle de bain privée *f* 100  
 salle de cinéma *f* 255  
 salle de classe *f* 162  
 salle de conférence *f* 174  
 salle de cours *f* 169  
 salle de départ *f* 213  
 salle de lecture *f* 168  
 salle de sport *f* 101  
 salle de tribunal *f* 180  
 salle des moteurs *f* 214  
 salle des urgences *f* 48  
 salon *m* 62  
 salon de coiffeur *m* 115  
 salopette *f* 30  
 salto *m* 235  
 samedi *m* 306  
 sandale *f* 37  
 sandales *f* 31  
 sandwich *m* 155  
 sandwich grillé *m* 149  
 sandwich mixte *m* 155  
 sangle *f* 242  
 sans 320  
 sans arêtes 121  
 sans bretelles 34  
 sans connaissance 47  
 sans manches 34  
 sans matières grasses 137  
 sans peau 121  
 sans pépins 127  
 sans plomb 199  
 santé *f* 44  
 Sao Tomé-et-Principe 317  
 sapeurs-pompiers *m* 95  
 saphir *m* 288  
 Sardaigne 316  
 sardine *f* 120  
 sas d'équipage *m* 281  
 satellite *m* 281  
 satsuma *f* 126  
 Saturne *f* 280  
 sauce *f* 134, 143, 155  
 saucisse *f* 155, 157  
 saucissons *m* 118  
 saucisson piquant *m* 142  
 sauf 228  
 sauge *f* 133  
 saule *m* 296  
 saumon *m* 120  
 sauna *m* 250  
 saut *m* 235, 237, 243, 247  
 saut à l'élastique *m* 248  
 saut à la corde *m* 251  
 saut à la perche *m* 234  
 saut en chute libre *m* 248  
 saut en hauteur *m* 235  
 saut en longueur *m* 235  
 sauté 159  
 sauté *m* 158  
 sauter 67, 227  
 sauterelle *f* 295  
 sauvegarder 177  
 sauver 223  
 savon *m* 73  
 saxophone *m* 257  
 scalpel *m* 81, 167  
 scanner *m* 176

- scanographie *f* 48  
 scaphandre spatial *m*  
   281  
 scarabée *m* 295  
 scène *f* 254, 258  
 schiste *m* 288  
 scie à chantourner *f* 81  
 scie à dossier *f* 81  
 scie à main *f* 89  
 scie circulaire *f* 78  
 scie égoïne *f* 80  
 scie sauteuse *f* 78  
 science *f* 166  
 sciences *f* 162  
 sciences économiques *f*  
   169  
 sciences politiques *f* 169  
 scientifique *f* 190  
 scier 79  
 scooter *m* 205  
 score *m* 220  
 scorpion *m* 295  
 scotch 173  
 scotch à l'eau *m* 151  
 Scrabble *m* 272  
 scrotum *m* 21  
 sculpter 79  
 sculpteur *m* 191  
 sculpture *f* 275  
 sculpture sur bois *f* 275  
 se coucher 71  
 se faire des amis 26  
 se lever 71, 139  
 se marier 26  
 se mettre à quai 217  
 se noyer 239  
 se réveiller 71  
 seau *m* 77, 82, 265  
 seau à glace *m* 150  
 sec 39, 41, 130, 145,  
   286, 321  
 sécateur *m* 89  
 s'échauffer 251  
 séché 129, 143, 159  
 sèche-cheveux *m* 38  
 sèche-linge *m* 76  
 sécher 38, 76  
 seconde *f*  
 secrétariat *m* 168  
 section *f* 282  
 sécurité *f* 75, 212, 240  
 sédatif *m* 109  
 sédimentaire 288  
 seiche *f* 121  
 sein *m* 12  
 seize 308  
 seizième 309  
 sel *m* 64, 152  
 sélecteur de point *m*  
   276  
 selle *f* 204, 206, 242  
 selle de femme *f* 242  
 semaine *f* 306  
 semaine dernière 307  
 semaine prochaine 306  
 semelle *f* 37  
 semer 90, 183  
 semis *m* 91  
 semoule *f* 130  
 s'endormir 71  
 Sénégal 317  
 sens interdit 195  
 sensible 41  
 sentier *m* 262  
 s'entraîner 251  
 sept 308  
 sept cents 308  
 septembre *m* 306  
 septième 309  
 série télévisée *f* 178, 179  
 seringue *f* 109, 167  
 serpent *m* 293  
 serre *f* 85  
 serre-joint *m* 78  
 serre-tête *m* 38  
 serrure *f* 59  
 serrure de sécurité *f* 75  
 serveur *m* 148, 176  
 serveur d'accès *m* 177  
 serveuse *f* 191  
 service *m* 231  
 service après-vente *m*  
   104, 175  
 service compris 152  
 service de blanchisserie *m*  
   101  
 service de ménage *m*  
   101  
 service de messagerie *m*  
   99  
 service de prêt *m* 168  
 service de ressources  
   humaines *m* 175  
 service de santé *m* 168  
 service de  
   soins intensifs *m* 48  
 service des ventes *m*  
   175  
 service d'étage *m* 101  
 service du contentieux *m*  
   175  
 service marketing *m* 175  
 service non compris  
   152  
 services *m* 49  
 services d'urgence *m*  
   94, 99  
 serviette *f* 37, 65, 73,  
 serviette antiseptique *f*  
   47  
 serviette de bain *f* 73  
 serviette de plage *f* 265  
 serviette en papier *f* 154  
 serviette hygiénique *f*  
   108  
 serviettes *f* 73  
 servir 64  
 set *m* 230  
 set de table *m* 64  
 s'évanouir 25, 44  
 shaker à cocktails  
   *m* 150  
 shampoing *m* 38  
 sherry *m* 145  
 shiatsu *m* 54  
 shooter 223  
 short *m* 33  
 Sibérie *f* 313  
 Sicile 316  
 siècle *m* 307  
 siège *m* 52, 61, 209,  
   210, 242  
 siège arrière *m* 200, 204  
 siège d'enfant *m* 198,  
   207  
 siège des toilettes *m* 72  
 siège du conducteur *m*  
   196  
 siège social *m* 175  
 Sierra Leone 317  
 signal *m* 209  
 signalisations *f* 194  
 signature *f* 96, 98  
 s'il vous plaît 322  
 silence *m* 256  
 silencieux *m* 203, 204  
 silex *m* 288  
 sillet *m* 258  
 sillon *m* 183  
 silo *m* 183  
 simple *m* 230  
 simple 151  
 Singapour 319  
 singe *m* 291  
 sinus *m* 19  
 sirène *f* 94  
 sirop *m* 109  
 sirop d'érable *m* 134  
 site web *m* 177  
 six 308  
 six cents 308  
 sixième 309  
 ski *m* 241, 246  
 ski alpin *m* 247  
 ski de randonnée *m* 247  
 ski nautique *m* 241  
 skieur nautique *m* 241  
 skieuse *f* 246  
 slalom *m* 247  
 slalom géant *m* 247  
 slice *m* 230  
 slip *m* 33, 35  
 slip de bain *m* 238  
 Slovaquie 316  
 Slovénie 316  
 smartphone *m* 99, 176  
 smash *m* 231  
 SMS *m* 99  
 snack *m* 148  
 société *f* 175  
 soda *m* 144  
 cœur *f* 22  
 soigner 91  
 soin dentaire *m* 108  
 soin du visage *m* 41  
 soins de beauté *m* 41  
 soins de bébé *m* 74,  
   104  
 soins de la peau *m* 108  
 soir *m* 305  
 soixante 308  
 soixante-dix 308  
 soixante-dixième 309  
 soixantième 309  
 sol *m* 62, 71, 85  
 soldat *m* 189  
 sole *f* 120  
 soleil *m* 280, 286  
 solides *m* 164  
 soluble 109  
 solution désinfectante *f*  
   51  
 solution nettoyante *f* 51  
 solvant *m* 83  
 Somalie 317  
 sommet *m* 165, 284  
 somnifère *m* 109  
 son *m* 130  
 sonate *f* 256  
 sonde *f* 50  
 sonnette *f* 59, 197  
 sorbet *m* 141  
 sortie *f* 61, 75, 210  
 sortie de secours *f* 210  
 Soudan 317  
 Soudan du Sud 317  
 souder 79  
 soudure *f* 79, 80  
 soufflé *m* 158  
 souffler 141  
 soufre *m* 289  
 soupape de sûreté *f* 61  
 soupe *f* 153  
 soupire 25  
 sourcil *m* 14, 51  
 sourire *m* 25  
 souris *f* 176, 290  
 sous 320  
 sous tension 60  
 sous-exposé 271  
 sous-marin *m* 215  
 sous-sol *m* 58, 91  
 soustraire 165  
 sous-vêtements *m* 32  
   35, 267  
 soutien-gorge *m* 35  
 soutien-gorge  
   d'allaitement *m* 53  
 souvenirs *m* 260  
 sparadrap *m* 47  
 spatule *f* 68, 167, 275  
 spécialiste *m* 49  
 spécialités *f* 152  
 spectateurs *m* 233  
 sperme *m* 20  
 sphère *f* 164  
 sportif *m* 191  
 sports *m* 220, 236  
 sports aquatiques *m* 241  
 sports d'hiver *m* 247  
 sports de combat *m* 236  
 spray *m* 109  
 spray contre  
   les insectes *m* 267  
 sprinter *m* 234  
 squash *m* 231  
 squelette *m* 17  
 Sri Lanka 318  
 stade *m* 223  
 stades *m* 23  
 starting block *m* 234  
 statif *m* 166  
 station de radio *f* 179  
 station de taxis *f* 213  
 station spatiale *f* 281  
 station-service *f* 199  
 statuette *f* 260  
 steeple *m* 243  
 sténographe *m* 181  
 stéréo 269  
 stéréo *f* 201  
 stérile 47, 20  
 stérilet *m* 21  
 sternum *m* 17  
 stéthoscope *m* 45  
 store *m* 63, 148  
 store vénitien *m* 63  
 stratosphère *f* 286  
 streaming *m* 269  
 stress *m* 55  
 studio d'enregistrement *m*  
   179  
 studio de télévision *m*  
   178  
 styles *m* 239, 301  
 styles de jardin *m* 84  
 styles de musique *m*  
   259  
 styliste *m* 277  
 stylo *m* 163  
 succursale *f* 175  
 sucette *f* 113  
 sucré 124, 127, 155  
 sud *m* 312  
 Suède 316  
 Suisse *f* 316  
 sumo *m* 237  
 superficie *f* 310  
 supermarché *m* 106  
 supplément *m* 55  
 support *m* 88, 166, 187,  
   268  
 suppositoire *m* 109  
 sur 320  
 surexposé 271  
 surf *m* 241  
 surf des neiges *m* 247  
 surface de but *f* 221,  
   223  
 surface de réparation *f*  
   223  
 surfer *m* 241  
 surgelé 121, 124  
 Surinam 315  
 surpris 25  
 survêtement *m* 31, 32  
 suspect *m* 94, 181  
 suspension *f* 203, 205  
 Swaziland 317  
 sweat-shirt *m* 33

swing d'essai *m* 233  
 swing en arrière *m* 233  
 symphonie *f* 256  
 synagogue *f* 300  
 synthétique 31  
 Syrie 318  
 système *m* 176  
 système solaire *m* 280  
 systèmes domestiques *m*  
 60  
 systèmes du corps *m* 19

## T

tabac *m* 112, 184  
 table *f* 64, 148  
 table à encoller *f* 82  
 table basse *f* 62  
 table de cuisson *f* 67  
 table de cuisson  
 vitrocéramique *f* 66  
 table de nuit *f* 70  
 table du petit déjeuner *f*  
 156  
 tableau *m* 62, 162, 261,  
 274  
 tableau à feuilles  
 mobiles *m* 174  
 tableau de bord *m* 201  
 tableau des points *m*  
 225  
 tablette *f* 210  
 tablette de chocolat *f*  
 113  
 tablier *m* 30, 69  
 tabouret de bar *m* 150  
 tache de rousseur *f* 15  
 tache rouge *f* 271  
 tacler 220, 223  
 taco *m* 155  
 Tadjikistan 318  
 taekwondo *m* 236  
 taï chi *m* 236  
 taie d'oreiller *f* 71  
 taille *f* 12  
 taille-crayon *m* 163  
 tailler 90  
 tailleur *m* 115  
 Taiwan 319  
 talc *m* 73  
 talon *m* 13, 15, 37, 96  
 tamarillo *m* 128  
 tambour *m* 245, 257  
 tamis *m* 89  
 tamiser 91, 138  
 tampon *m* 108  
 tampon de la poste *m* 98  
 tampon encreur 173  
 tandem *m* 206  
 tangelo *m* 126  
 tante *f* 22  
 Tanzanie *f* 317  
 tapis *m* 54, 63, 71, 235  
 tapis de bain *m* 72  
 tapis de sol *m* 267  
 tapis roulant *m* 106,  
 212, 250

tapisser 82  
 tapisserie *f* 277  
 tapissier décorateur *m*  
 82  
 taquet *m* 240  
 tard 305  
 tarif *m* 154, 199  
 tarif d'affranchissement *m*  
 98  
 taro *m* 124  
 tarte *f* 141  
 tarte à la crème *f* 141  
 tarte aux fruits *f* 140  
 tas de compost *m* 85  
 Tasmanie 319  
 tasse *f* 75  
 tasse à café *f* 65  
 tasse à thé *f* 65  
 tatouage *m* 41  
 taureau *m* 185  
 taux d'intérêt *m* 96  
 taux de change *m* 97  
 Tchad 317  
 techniques *f* 79  
 tee *m* 233  
 teint *m* 41  
 teint 39  
 teinture de cheveux *f* 40  
 télécabine *f* 246  
 télécharger 177  
 télécommande *f* 269  
 télégramme *m* 98  
 téléphone *m* 99  
 téléphone de secours *m*  
 195  
 téléphone public *m* 99  
 téléphone sans fil *m* 99  
 téléphoniste *m* 99  
 téléprompateur *m* 179  
 télescope *m* 281  
 télésiège *m* 246  
 télévision *f* 268  
 télévision à écran plat *f*  
 269  
 télévision par câble *f* 269  
 témoin *m* 180  
 tempe *f* 14  
 température *f* 286  
 tempête *f* 286  
 temple *m* 300  
 temps *m* 234, 286  
 temps libre *m* 254, 258,  
 264  
 temps mort *m* 220  
 tendon *m* 17  
 tendon d'Achille *m* 16  
 tendon du jarret *m* 16  
 tennis *m* 230, 231  
 tennis de table *m* 231  
 tensiomètre électronique  
*m* 45  
 tension *f* 44, 60  
 tente *f* 267  
 tenue de foot *f* 31  
 téquila *f* 145  
 térébenthine *f* 83

terminal *m* 212  
 terminal de ferrys *m* 216  
 termite *f* 295  
 terrain *m* 220, 222, 226,  
 228, 234  
 terrain de camping *m*  
 266  
 terrain de cricket *m* 225  
 terrain de jeux *m* 263  
 terrain de rugby *m* 221  
 terrain de sport *m* 168  
 terrasse de café *f* 148  
 terrasse de café *f* 148  
 terre *f* 85, 282  
 Terre *f* 280  
 terreau *m* 88  
 terre-plein *m* 194  
 terres cultivées *f* 182  
 territoire *m* 315  
 test de grossesse *m* 52  
 testicule *m* 21  
 têtard *m* 294  
 tête *f* 12, 19, 81, 230  
 tête du lit *f* 70  
 tétine *f* 75  
 texte *m* 254  
 texto *m* 99  
 Thaïlande 318  
 thé *m* 144, 149, 184  
 thé au citron *m* 149  
 thé au lait *m* 149  
 thé glacé *m* 149  
 thé nature *m* 149  
 thé vert *m* 149  
 théâtre *m* 254, 299  
 théière *f* 65  
 thénar *m* 15  
 thérapeute *f* 55  
 thérapie de groupe *f* 55  
 thérapies alternatives *f*  
 54  
 thermomètre *m* 44, 167,  
 201  
 thermos *m* 267  
 thermosphère *f* 286  
 thermostat *m* 61  
 thèse *f* 169  
 thon *m* 120  
 thriller *m* 255  
 thym *m* 133  
 thyroïde *f* 18  
 tibia *m* 12, 17  
 ticket *m* 197  
 tiebrake *m* 230  
 tige *f* 111, 297  
 tige de verre *f* 167  
 tigre *m* 291  
 tilleul *m* 296  
 timbale *f* 257  
 timbre *m* 98  
 timbres *m* 112  
 timide 25  
 Timor oriental 319  
 tir à cible *m* 249  
 tir à l'arc *m* 249  
 tire-bouchon *m* 150

tirer 227, 251  
 tiroir *m* 66, 70, 172  
 tisane *f* 149  
 tissage *m* 277  
 tissu *m* 276, 277  
 titre *m* 168  
 titres *m* 23, 97  
 toast *m* 157  
 toboggan *m* 263  
 Togo *m* 317  
 toile *f* 274  
 toile de fond *f* 254  
 toile métallique *f* 167  
 toilettes *f* 72, 104, 266  
 toise *f* 45  
 toit *m* 58, 203  
 toit ouvrant *m* 202  
 tomate *f* 125, 157  
 tomate cerise *f* 124  
 tomber amoureux 26  
 ton *m* 41, 256  
 tondeuse *f* 88, 90  
 tondeuse à gazon *f* 88  
 tondre 90  
 tong *f* 37  
 tonic *m* 144  
 tonique *m* 41  
 tonne *f* 310  
 tonnerre *m* 286  
 topaze *m* 288  
 topiaire *f* 87  
 topinambour *m* 125  
 toque *f* 190  
 tornade *f* 287  
 tortue *f* 293  
 tortue marine *f* 293  
 tôt 305  
 touche *f* 176  
 tour *f* 272, 301  
 tour *m* 238  
 tour de batte *m* 228  
 tour de contrôle *f* 212  
 tour de potier *m* 275  
 tour de surveillance *f*  
 265  
 tourelle *f* 300  
 tourisme *m* 260  
 touriste *m* 260  
 tourmaline *f* 288  
 tourne-disque *m* 268  
 tourner 79  
 tournesol *m* 184, 297  
 tournevis *m* 80  
 tournevis cruciforme *m*  
 81  
 tournois *m* 233  
 tourte *f* 158  
 tourtière *f* 69  
 tout droit 260  
 toux *f* 44  
 trachée *f* 18  
 tracteur *m* 182  
 traction *f* 251  
 traction pour les jambes *f*  
 251  
 train *m* 208

train à grande vitesse  
*m* 208  
 train à vapeur *m* 208  
 train d'atterrissage *m* 210  
 train de marchandises *m*  
 208  
 train diesel *m* 208  
 train électrique *m* 208  
 traîne *f* 35  
 traîneau à chiens *m* 247  
 traire 183  
 tram *m* 208  
 tramway *m* 196  
 tranche *f* 119, 121, 139,  
 140  
 tranche de lard *f* 119  
 transat *m* 265  
 transfert *m* 223  
 transformateur *m* 60  
 transmission *f* 202  
 transplanter 91  
 transport *m* 194  
 trapèze *m* 16, 164  
 traumatisme crânien *m* 46  
 travail 172  
 travaux *m* 187, 195  
 travailler *m* 97  
 trèfle *m* 273, 297  
 treillis *m* 84  
 treize 308  
 treizième 309  
 tremblement *m* 283  
 tremplin *m* 235, 238  
 trente 308  
 trentième 309  
 trépied *m* 166, 270, 281  
 très chaud 286  
 triangle *m* 164, 257  
 triceps *m* 16  
 tricot *m* 277  
 tricot de corps *m* 33  
 trictrac *m* 272  
 trimestre *m* 52  
 Trinité-et-Tobago 314  
 triste 25  
 trognon *m* 122, 127  
 trois 308  
 trois cents 308  
 troisième 309  
 trolleybus *m* 196  
 trombone *m* 257  
 trombone 173  
 trompe *f* 291  
 trompe de Fallope *f* 20  
 trompette *f* 257  
 tronç *m* 296  
 tropique du cancer *m*  
 283  
 tropique du capricorne *m*  
 283  
 tropiques *f* 283  
 troposphère *f* 286  
 trop-plein *m* 61  
 trot *m* 243  
 trotteuse *f* 304  
 trottoir *m* 298

- trou *m* 232  
 trou en un *m* 233  
 trou noir *m* 280  
 troupeau *m* 183  
 trousse *f* 163  
 trousse de premiers secours *f* 47  
 trouver un emploi 26  
 trueller *f* 187  
 truffe *f* 113, 125  
 truite *f* 120  
 truite arc-en-ciel *f* 120  
 T-shirt *m* 30, 33  
 tuba *m* 239, 257  
 tube *m* 230, 311  
 tube porte-selle *m* 206  
 tuile *f* 58, 187  
 tulipe *f* 111  
 Tunisie *f* 317  
 turbocompresseur *m* 203  
 Turkmenistan 318  
 Turquie *f* 316  
 turquoise *f* 289  
 tuteur *m* 90  
 tutu *m* 191  
 tuyau *m* 95, 112, 202  
 tuyau d'arrosage *m* 89  
 tuyau d'écoulement *m* 61, 72  
 tuyau flexible *m* 77  
 types *m* 205  
 types d'appareils photo *m* 270  
 types de bus *m* 196  
 types de trains *m* 208
- U**  
 U.F.R. *f* 169  
 U.L.M. *m* 211  
 Ukraine *f* 316  
 ultrasons *m* 52  
 un 308  
 under par *m* 233  
 uniforme *m* 94, 189  
 univers *m* 280  
 université *f* 299  
 Uranus *f* 280  
 uretère *m* 21  
 urètre *m* 20  
 urgence *f* 46  
 urinaire 19  
 urologie *f* 49  
 Uruguay 315  
 usine *f* 299  
 ustensiles de cuisine *m* 68, 105  
 utérus *m* 20, 52  
 utiliser le fil dentaire 50
- V**  
 vacances *f* 212  
 vaccination *f* 45  
 vache *f* 185  
 vagin *m* 20  
 vague *f* 241, 264
- vaisselle *f* 64  
 vaisselle et les couverts *f* 65  
 valet *m* 273  
 valet d'écurie *m* 243  
 valeur *f* 97  
 vallée *f* 284  
 valve *f* 207  
 vanille *f* 132  
 Vanuatu 319  
 vaporisateur *m* 89  
 varicelle *f* 44  
 vase *f* 85  
 vase *m* 63, 111  
 veau *m* 118, 185  
 véhicule de service *m* 212  
 veille de la Toussaint *f* 27  
 veine *f* 19  
 vélo *m* 263  
 vélo de course *m* 206  
 vélo de randonnée *m* 206  
 vélo de ville *m* 206  
 vélo d'entraînement *m* 250  
 vélo tous terrains *m* 206  
 venaison *f* 118  
 vendeur *m* 104  
 vendredi *m* 306  
 Venezuela 315  
 vent *m* 241, 286  
 venteux 286  
 ventilateur *m* 60, 202, 210  
 ventouse *f* 53, 81  
 ventre *m* 12  
 Vénus *f* 280  
 ver *m* 295  
 verdict *m* 181  
 vernis *m* 79, 83  
 vernis à ongles *m* 41  
 verre *m* 51, 65, 152  
 verre à vin *m* 65  
 verre gradué *m* 150  
 verre mesureur 69, 311  
 verrerie *f* 64  
 verres *m* 150  
 verrou *m* 59  
 verrouillage *m* 200  
 vers 320  
 verser 67, 96  
 vert 129, 274  
 vertèbres cervicales *f* 17  
 vertèbres thoraciques *f* 17  
 vésicule *f* 21  
 vessie *f* 20  
 veste *f* 32, 34  
 veste de ski *f* 246  
 veste de sport *f* 33  
 vestibule *m* 59  
 vêtement en cuir *m* 205  
 vêtements *m* 205  
 vêtements de nuit *m* 31  
 vêtements pour enfants *m* 30
- vêtements pour femmes *m* 34, 105  
 vêtements pour hommes *m* 32, 105  
 vêtements sport *m* 33  
 vétérinaire *f* 189  
 viande *f* 119  
 viande blanche *f* 118  
 viande cuite *f* 118, 143  
 viande et la volaille *f* 106  
 viande hachée *f* 119  
 viande maigre *f* 118  
 viande non cuite *f* 142  
 viande rouge *f* 118  
 vibraphone *m* 257  
 vide 321  
 vide-pomme *m* 68  
 Vietnam 318  
 vieux 321  
 vigne *f* 183  
 vilebrequin *m* 78  
 village *m* 299  
 ville *f* 298, 299  
 vin *m* 145, 151  
 vinaigre *m* 135, 142  
 vinaigre balsamique *m* 135  
 vinaigre de cidre *m* 135  
 vinaigre de malt *m* 135  
 vinaigrette *f* 158  
 vingt 308  
 vingt et un 308  
 vingt et unième 309  
 vingt mille 309  
 vingt minutes  
 vingt-deux 308  
 vingt-deuxième 309  
 vingtième 309  
 vingt-troisième 309  
 violet 274  
 violon *m* 256  
 violoncelle *m* 256  
 virement *m* 96  
 virus *m* 44  
 vis *f* 80  
 visa *m* 213  
 visage *m* 14  
 viseur *m* 271  
 visière *f* 205  
 visiophone *m* 99  
 visite de contrôle *m* 50  
 visite guidée *f* 260  
 vitamines *f pl* 108  
 vitesses *f* 206  
 vivace 86  
 vodka *f* 145  
 vodka à l'orange *f* 151  
 voie à sens unique *f* 298  
 voie centrale *f* 194  
 voie de dépassement *f* 194  
 voie ferrée *f* 208  
 voile *f* 240, 241  
 voile *m* 35  
 voile d'avant *f* 240
- vollier *m* 215  
 voisin *m* 24  
 voiture *f* 198, 200, 208  
 voiture à six places *f* 199  
 voiture de police *f* 94  
 voiture de pompiers *f* 95  
 voiture d'époque *f* 199  
 voiture électrique *f* 199  
 voiture-restaurant *f* 209  
 vol domestique *m* 212  
 vol international *m* 212  
 vol plané *m* 248  
 volaille *f* 119  
 volant *m* 201, 231  
 volcan *m* 283  
 voler 211  
 volet *m* 58  
 vollée *f* 231  
 volley *m* 227  
 volume *m* 165, 179, 269, 311  
 vomir 44  
 voûte *f* 300  
 voyage d'affaires *m* 175  
 voyage de noces *m* 26  
 voyageur *m* 208  
 vue *f* 51
- W**  
 W.-C. *m* 61  
 water-polo *m* 239  
 week-end *m* 306  
 western *m* 255  
 whisky *m* 145  
 white-spirit *m* 83  
 wifi *m* 269  
 wok *m* 69
- Y**  
 yacht *m* 215, 240  
 yaourt *m* 137  
 yaourt aux fruits *m* 157  
 yaourt surgelé *m* 137  
 yard *m* 310  
 Yémen 318  
 yoga *m* 54  
 Yougoslavie 316
- Z**  
 Zambie *f* 317  
 zèbre *m* 291  
 zéro 230, 308  
 zeste *m* 126  
 Zimbabwe *m* 317  
 zinc *m* 289  
 zone *f* 315  
 zone d'attaque *f* 224  
 zone de défense *f* 224  
 zone de fond *f* 220  
 zone industrielle *f* 299  
 zone neutre *f* 224  
 zone piétonnière *f* 299  
 zones *f* 283  
 zoo *m* 262  
 zoologie *f* 169  
 zoom *m* 270

## index anglais • English index

## A

- à la carte 152  
 abdomen 12  
 abdominals 16  
 above 320  
 acacia 110  
 accelerator 200  
 accessories 36, 38  
 accident 46  
 account number 96  
 accountant 97, 190  
 accounts department 175  
 accused 180  
 ace 230, 273  
 Achilles tendon 16  
 acorn squash 125  
 acquaintance 24  
 acquitted 181  
 across 320  
 acrylic paints 274  
 actions 237, 229, 227, 233, 183  
 activities 263, 245, 162, 77  
 actor 254, 191  
 actors 179  
 actress 254  
 acupressure 55  
 acupuncture 55  
 Adam's apple 19  
 add v 165  
 address 98  
 adhesive tape 47  
 adjustable wrench 80  
 admission charge 260  
 admissions office 168  
 admitted 48  
 aduki beans 131  
 adult 23  
 advantage 230  
 adventure 255  
 advertisement 269  
 aerate v 91  
 Afghanistan 318  
 Africa 317  
 after 320  
 afternoon 305  
 aftershave 73  
 after-sun 108  
 agate 289  
 agenda 174  
 aikido 236  
 aileron 210  
 air bag 201  
 air conditioning 200  
 air cylinder 239  
 air filter 202, 204  
 air letter 98  
 air mattress 267  
 air vent 210  
 aircraft 210  
 aircraft carrier 215  
 airliner 210, 212  
 airport 212  
 aisle 106, 168, 210, 254  
 alarm clock 70  
 Alaska 314  
 Albania 316  
 alcoholic drinks 145  
 alfalfa 184  
 Algeria 317  
 all-purpose flour 139  
 allergy 44  
 alley 298  
 alligator 293  
 alligator clip 167  
 allspice 132  
 almond 129  
 almond oil 134  
 almonds 151  
 along 320  
 alpine 87  
 alpine skiing 247  
 alternating current 60  
 alternative therapy 54  
 alternator 203  
 altitude 211  
 aluminum 289  
 Amazonia 312  
 ambulance 94  
 amethyst 288  
 amniocentesis 52  
 amniotic fluid 52  
 amount 96  
 amp 60  
 amphibians 294  
 amplifier 268  
 analog (radio) 179  
 anchor 214, 240  
 Andes 312  
 Andorra 316  
 anesthetist 48  
 angle 164  
 angler 244  
 Angola 317  
 angry 25  
 animals 292, 294  
 animated film 255  
 ankle 13, 15  
 ankle-length 34  
 anniversary 26  
 annual 86, 307  
 answer 163  
 answer v 99, 163  
 answering machine 99  
 ant 295  
 antenna 295  
 antifreeze 199, 203  
 Antigua and Barbuda 314  
 anti-inflammatory 109  
 antique shop 114  
 antiseptic 47  
 antiseptic wipe 47  
 anti-wrinkle 41  
 antler 291  
 apartment building 298  
 apéritif 153  
 aperture dial 270  
 apex 165  
 app 99  
 appeal 181  
 appearance 30  
 appendix 18  
 applaud v 255  
 apple 126  
 apple corer 68  
 apple juice 149  
 appliances 66  
 application 176  
 appointment 45, 175  
 apricot 126  
 April 306  
 apron 30, 50, 69, 212  
 aquamarine 288  
 Arabian Sea 313  
 arc 164  
 arch 15, 85, 301  
 archery 249  
 architect 190  
 architecture 300  
 architrave 301  
 Arctic Circle 283  
 Arctic Ocean 312  
 area 165, 310  
 areas 299  
 arena 243  
 Argentina 315  
 arithmetic 165  
 arm 13  
 armband 238  
 armchair 63  
 Armenia 318  
 armpit 13  
 armrest 200, 210  
 aromatherapy 55  
 around 320  
 arrangements 111  
 arrest 94  
 arrivals 213  
 arrow 249  
 art 162  
 art college 169  
 Art Deco 301  
 art gallery 261  
 art history 169  
 Art Nouveau 301  
 art shop 115  
 artery 19  
 artichoke 124  
 artist 274  
 arts and crafts 274, 276  
 ash 283  
 ashtray 150  
 Asia 318  
 asparagus 124  
 asphalt 187  
 assault 94  
 assistant 24  
 assisted delivery 53  
 asteroid 280  
 asthma 44  
 astigmatism 51  
 astronaut 281  
 astronomy 281  
 asymmetric bars 235  
 at 320  
 athlete 234  
 athletic shoes 31, 251  
 Atlantic Ocean 312  
 ATM 97  
 atmosphere 282, 286  
 atrium 104  
 attachment 177  
 attack 220  
 attack zone 224  
 attend v 174  
 attic 58  
 attractions 261  
 auburn 39  
 audience 254  
 August 306  
 aunt 22  
 aurora 286  
 Australasia 319  
 Australia 319  
 Austria 316  
 automatic 200  
 automatic door 196  
 automatic payment 96  
 avalanche 247  
 avenue 299  
 avocado 128  
 awning 148  
 ax 95  
 axle 205  
 ayurveda 55  
 Azerbaijan 318
- B**  
 baby 23, 30  
 baby bath 74  
 baby care 74  
 baby changing facilities 104  
 baby monitor 75  
 baby products 107  
 baby sling 75  
 back 13  
 back brush 73  
 back seat 200  
 back up v 195  
 backboard 226  
 backdrop 254  
 backgammon 272  
 backhand 231  
 backpack 31, 37, 267  
 backslash 66  
 backstroke 239  
 backswing 233  
 bacon 118, 119, 157  
 bad 321  
 badge 94, 189  
 badminton 231  
 bag 311  
 bagel 139  
 baggage claim 213  
 baggage trailer 212  
 bags 37  
 baguette 138  
 Bahamas 314  
 bail 181  
 bailiff 180  
 bait 244  
 bait v 245  
 bake v 67, 138  
 baked 159  
 baker 139  
 baker's 114  
 bakery 107, 114, 138  
 baking 69  
 baking sheet 69  
 balance wheel 276  
 balcony 59, 254  
 bald 39  
 bale 184  
 Balearic Islands 316  
 ball 15, 75, 221, 224, 226, 228, 230  
 ball boy 231  
 ballet 255  
 balsamic vinegar 135  
 Baltic Sea 313  
 bamboo 86, 122  
 banana 128  
 bandage 47  
 Bangladesh 318  
 banister 59  
 bank 96, 284  
 bank charge 96  
 bank manager 96  
 bank transfer 96  
 bar 150, 152, 250, 256, 311  
 bar code 106  
 bar counter 150  
 bar mitzvah 26  
 bar snacks 151  
 bar stool 150  
 barb 244  
 Barbados 314  
 barbecue 267  
 barber 39, 188  
 bark 296



- barley 130, 184  
 barn 182  
 baroque 301  
 bars 74  
 bartender 150, 191  
 basalt 288  
 base 164, 229  
 base station 99  
 baseball 228  
 baseline 230  
 baseman 228  
 basement 58  
 basil 133  
 basket 106, 207, 226  
 basket of fruit 126  
 basketball 226  
 basketball player 226  
 basque 35  
 bass clarinet 257  
 bass clef 256  
 bass guitar 258  
 bassinet 74  
 bassoon 257  
 bat 225, 228, 231, 290  
 bat v 225, 229  
 bath mat 72  
 bath towel 73  
 bathrobe 31, 32, 73  
 bathroom 72  
 bathtub 72  
 baton 235, 256  
 batsman 225  
 batter 228  
 batteries 260  
 battery 167, 202  
 battery pack 78  
 battleship 215  
 bay leaf 133  
 be born v 26  
 beach 264  
 beach bag 264  
 beach ball 265  
 beach hut 264  
 beach towel 265  
 beach umbrella 264  
 beaker 167  
 beam 186, 235  
 bean sprout 122  
 beans 131, 144  
 bear 291  
 beat 259  
 beauty 40, 105  
 beauty treatments 41  
 bed 70  
 bed and breakfast 101  
 bed linen 71  
 bedding 74  
 bedroom 70  
 bedside lamp 70  
 bedspread 70  
 bee 295  
 beech 296  
 beef 118  
 beer 145, 151  
 beer tap 150  
 beetle 295  
 beet 125  
 before 320  
 beginning 321  
 behind 320  
 Belarus 316  
 Belgium 316  
 Belize 314  
 bell 197  
 below 320  
 belt 32, 36, 236  
 bench 250, 262  
 Benin 317  
 berry 296  
 beside 320  
 bet 273  
 between 320  
 beyond 320  
 Bhutan 318  
 biathlon 247  
 biathlon 247  
 bib 30  
 biceps curl 251  
 biceps 16  
 bicycle 206  
 bidet 72  
 biennial 86  
 bifocal 51  
 big toe 15  
 bike rack 207  
 bikini 264  
 bill 152, 293  
 binoculars 281  
 biology 162  
 biplane 211  
 birch 296  
 bird-watching 263  
 birds 292  
 birth 52  
 birth weight 53  
 birth certificate 26  
 birthday 27  
 birthday cake 141  
 birthday candles 141  
 birthday party 27  
 bishop 272  
 bit 242  
 bit brace 78  
 bite 46  
 bite v 245  
 bitter 124, 145  
 black 39, 272, 274  
 black belt 237  
 black coffee 148  
 black currant 127  
 black hole 280  
 black olive 143  
 black pudding 157  
 Black Sea 313  
 black tea 149  
 blackberry 127  
 blackboard 162  
 black-eyed beans 131  
 bladder 20  
 blade 60, 66, 78, 89  
 blanket 71, 74  
 blazer 33  
 bleach 77  
 blender 66  
 blinder 46  
 block 237  
 block v 227  
 blonde 39  
 blood pressure 44  
 blood pressure gauge 45  
 blood test 48  
 blouse 34  
 blow-dry v 38  
 blow out v 141  
 blowhole 290  
 blue 274  
 blue cheese 136  
 bluebells 297  
 blueberry 127  
 blues 259  
 blusher 40  
 board 241  
 board v 217  
 board games 272  
 boarding pass 213  
 boardwalk 265  
 bob 39  
 bobbin 276  
 bobsled 247  
 body 12  
 body lotion 73  
 body systems 19  
 bodywork 202  
 boil v 67  
 boiled egg 137, 157  
 Bolivia 315  
 bollard 214, 298  
 bolt 59  
 bomber 211  
 bone 17, 119, 121  
 bone meal 88  
 boned 121  
 bongos 257  
 book 168  
 bookstore 115  
 bookshelf 63, 168  
 boom 95, 240  
 booster 281  
 boot 37  
 booties 30  
 bored 25  
 borrow v 168  
 Bosnia and Herzegovina 316  
 Botswana 317  
 bottle 61, 75, 135, 311  
 bottle opener 68, 150  
 bottled foods 134  
 bottled water 144  
 bottom tier 141  
 boundary line 225  
 bouquet 35, 111  
 bouquet garni 132  
 bout 237  
 boutique 115  
 bow 240, 249  
 bow tie 36  
 bowl 61, 65, 112  
 bowl v 225  
 bowler 225  
 bowling 249  
 bowling ball 249  
 box 254  
 box file 173  
 box of chocolates 113  
 box of tissues 70  
 box office 255  
 boxer shorts 33  
 boxercise 251  
 boxing 236  
 boxing gloves 237  
 boxing ring 237  
 boy 23  
 boyfriend 24  
 bra 35  
 braces 50  
 bracelet 36  
 braid 39  
 brain 19  
 brake 200, 204, 206  
 brake v 207  
 brake block 207  
 brake fluid reservoir 202  
 brake lever 207  
 brake pedal 205  
 bran 130  
 branch 296  
 brandy 145  
 brass 256  
 Brazil 315  
 Brazil nut 129  
 bread 157  
 bread flour 139  
 bread knife 68  
 bread roll 143  
 breadcrumbs 139  
 breadfruit 124  
 breads 138  
 break a record v 234  
 break water v 52  
 breakdown 203  
 breakfast 64, 156  
 breakfast buffet 156  
 breakfast cereals 107  
 breakfast table 156  
 breakfast tray 101  
 breast 12, 119  
 breast pump 53  
 breastbone 17  
 breastfeed v 53  
 breaststroke 239  
 breathing 47  
 breech 52  
 brick 187  
 bridge 15, 214, 258, 273, 300  
 bridle 242  
 bridle path 263  
 brie 142  
 briefcase 37  
 briefs 33, 35  
 brioche 157  
 broadcast 179  
 broadcast v 178  
 broccoli 123  
 brochure 96, 175  
 brogue 37  
 broil v 67  
 bronze 235  
 brooch 36  
 broom 77  
 broth 158  
 brother 22  
 brother-in-law 23  
 browband 242  
 brown 274  
 brown bread 139, 149  
 brown flour 138  
 brown lentils 131  
 brown rice 130  
 browse v 177  
 browser 177  
 bruise 46  
 Brunei 319  
 Brunette 39  
 brush 38, 40, 77, 83, 274  
 brush v 38, 50  
 Brussels sprout 122  
 bubble bath 73  
 buckle 36  
 bud 111, 297  
 buffet 152  
 build v 186  
 building site 186  
 buildings 299  
 built-in wardrobe 71  
 bulb 86  
 Bulgaria 316  
 bull 185  
 bulldog clip 173  
 bullnose pliers 80  
 bullseye 273  
 bumper 74, 198  
 bun 39, 140, 139, 155  
 bunch 111  
 bungalow 58  
 bungee jumping 248  
 bunker 232  
 bunsen burner 166  
 buoy 217  
 bureau de change 97  
 burger 154  
 burger bar 154  
 burger meal 154  
 burglar alarm 58  
 burglary 94  
 Burkina Faso 317  
 Burma (Myanmar) 318  
 burn 46  
 burner 67

- Burundi 317  
 bus 196  
 bus driver 190  
 bus stop 197  
 bus station 197  
 bus stop 197, 299  
 bus ticket 197  
 buses 196  
 business 175  
 business class 211  
 business deal 175  
 business lunch 175  
 business partner 24  
 business suit 32  
 business trip 175  
 businessman 175  
 businesswoman 175  
 busy 99  
 butcher 118, 188  
 butcher shop 114  
 butter 137, 156  
 butter beans 131  
 buttercup 297  
 butterfly 239, 295  
 buttermilk 137  
 butternut squash 125  
 buttock 13, 16  
 button 32  
 buttonhole 32  
 buttress 301  
 by 320  
 by airmail 98  
 bytes 176
- C**  
 cab 95  
 cab driver 190  
 cabbage 123  
 cabin 210, 214  
 Cabilia 317  
 cable 79, 207  
 cable car 246  
 cable television 269  
 cactus 87  
 caddy 233  
 cesarean section 52  
 café 148, 262  
 cafeteria 168  
 cafetière 65  
 cake pan 69  
 cakes 140  
 calcite 289  
 calcium 109  
 calculator 165  
 calendar 306  
 calf 13, 16, 185  
 call button 48  
 calyx 297  
 cam belt 203  
 Cambodia 318  
 camcorder 260, 269  
 camel 291  
 camembert 142  
 camera 178, 260, 270  
 camera case 271  
 camera crane 178  
 camera shop 115  
 cameraman 178  
 cameraphone 270  
 Cameroon 317  
 camisole 35  
 camp v 266  
 camp bed 266  
 campari 145  
 camper van 266  
 campfire 266  
 camping 266  
 camping stove 267  
 campground 266  
 campus 168  
 can 145, 289, 311  
 can opener 68  
 Canada 314  
 canary 292  
 candied fruit 129  
 candy 113  
 candy store 113  
 cane 91  
 canes 89  
 canine 50  
 canned drink 154  
 canned food 107  
 canoe 214  
 canoeing 241  
 canola oil 135  
 canter 243  
 canvas 274  
 cap 21, 36, 238  
 capacity 311  
 cape gooseberry 128  
 capers 143  
 capital 315  
 capoeira 237  
 cappuccino 148  
 capsize v 241  
 capsule 109  
 captain 214  
 car 198, 200  
 car accident 203  
 car rental 213  
 car seat 198, 207  
 car stereo 201  
 car wash 198  
 caramel 113  
 caraway 131  
 card 27  
 card slot 97  
 cardamom 132  
 cardboard 275  
 cardigan 32  
 cardiology 49  
 cardiovascular 19  
 cards 273  
 cargo 216  
 Caribbean Sea 312  
 carnation 110  
 carnival 27  
 carousel 212  
 carpenter 188  
 carpentry bits 80  
 carpet 71  
 carriage race 243  
 carrier 75, 204  
 carrot 124  
 carry-on luggage 211, 213  
 cart 48, 100, 106, 208, 213  
 cartilage 17  
 carton 311  
 cartoon 178  
 carve v 79  
 carving fork 68  
 case 51  
 cash v 97  
 cashew 129  
 cashews 151  
 cashier 96, 106  
 casino 261  
 Caspian Sea 313  
 cassava 124  
 casserole dish 69  
 cassette player 269  
 cassette tape 269  
 cast 254  
 cast v 245  
 castle 300  
 casual 34  
 casual wear 33  
 cat 290  
 catamaran 215  
 cataract 51  
 catch v 220, 227, 229, 245  
 catcher 229  
 caterpillar 295  
 cathedral 300  
 catheter 53  
 cauliflower 124  
 cave 284  
 CD 269  
 CD player 268  
 cedar 296  
 ceiling 62  
 celebration 140  
 celebration cakes 141  
 celebrations 27  
 celeriac 124  
 celery 122  
 cell 94, 181  
 cell phone 99  
 cello 256  
 cement 186  
 cement mixer 186  
 centimeter 310  
 centipede 295  
 Central African Republic 317  
 central reservation 194  
 center 164  
 center circle 222, 224, 226  
 center field 228  
 center line 226  
 centerboard 241  
 century 307  
 CEO 175  
 ceramic range 66  
 cereal 130, 156  
 cervical vertebrae 17  
 cervix 20, 52  
 Chad 317  
 chain 36, 206  
 chair 64  
 chair v 174  
 chairlift 246  
 chalk 85, 162, 288  
 chamber 283  
 chamomile tea 149  
 champagne 145  
 championship 230  
 change v 209  
 change a tire v 203  
 change channels v 269  
 change gears v 207  
 changing mat 74  
 changing room 104  
 channel 178  
 charcoal 266, 275  
 charge 94, 180  
 chart 48  
 chassis 203  
 check 96  
 checkbook 96  
 checkers 272  
 check-in v 212  
 check-in desk 213  
 checking account 96  
 checkout 106  
 checkup 50  
 cheddar 142  
 cheek 14  
 cheerleader 220  
 cheese 136, 156  
 chef 152, 190  
 chef's hat 190  
 chemistry 162  
 cherry 126  
 cherry tomato 124  
 chess 272  
 chessboard 272  
 chest 12  
 chest of drawers 70  
 chest press 251  
 chestnut 129  
 chewing gum 113  
 chick 185  
 chicken 119, 185  
 chicken burger 155  
 chicken coop 185  
 chicken nuggets 155  
 chicken pox 44  
 chicory 122  
 child 23, 31  
 child lock 75  
 childbirth 53  
 children 23  
 children's clothing 30  
 children's department 104  
 children's meal 153  
 children's ward 48  
 Chile 315  
 chili pepper 124, 132, 143  
 chill 44  
 chimney 58  
 chin 14  
 China 318  
 china 105  
 chip v 233  
 chips 113, 151  
 chipboard 79  
 chiropractic 54  
 chisel 81, 275  
 chives 133  
 chocolate 113  
 chocolate bar 113  
 chocolate cake 140  
 chocolate chip 141  
 chocolate-coated 140  
 chocolate milkshake 149  
 chocolate spread 135  
 choir 301  
 choke v 47  
 chop 119, 237  
 chorizo 143  
 choux pastry 140  
 christening 26  
 Christmas 27  
 chrysanthemum 110  
 chuck 78  
 church 298, 300  
 chutney 134  
 cider 145  
 cider vinegar 135  
 cigar 112  
 cigarettes 112  
 cilantro 133  
 cinnamon 133  
 circle 165, 254  
 circular saw 78  
 circuit training 251  
 circulation desk 168  
 circumference 164  
 citrus fruit 126  
 city 299  
 clam 121  
 clamp 78, 166  
 clamp stand 166  
 clapper board 179  
 clarinet 257  
 clasp 36  
 classical music 255, 259  
 classroom 162  
 claw 291  
 clay 85, 275  
 clean v 77  
 clean clothes 76

- cleaned 121  
 cleaner 188  
 cleaning equipment 77  
 cleaning fluid 51  
 cleanser 41  
 clear honey 134  
 cleat 240  
 cleaver 68  
 clementine 126  
 client 38, 175, 180  
 cliff 285  
 climber 87  
 climbing frame 263  
 clinic 48, 168  
 clipboard 173  
 clitoris 20  
 clock radio 70  
 closed 260, 321  
 cloth diaper 30  
 clothesline 76  
 clothespin 76  
 clothing 205  
 cloud 287  
 cloudy 286  
 clove 125  
 clover 297  
 cloves 133  
 club 273  
 club sandwich 155  
 clubhouse 232  
 clutch 200, 204  
 coach 196  
 coal 288  
 coast 285  
 coaster 150  
 coastguard 217  
 coat 32  
 coat hanger 70  
 cockatoo 293  
 cockle 121  
 cockpit 210  
 cockroach 295  
 cocktail 151  
 cocktail shaker 150  
 cocoa powder 148  
 coconut 129  
 cocoon 295  
 cod 120  
 coffee 144, 148, 153,  
     156, 184  
 coffee cup 65  
 coffee machine 148, 150  
 coffee milkshake 149  
 coffee spoon 153  
 coffee table 62  
 cog 206  
 coin 97  
 coin phone 99  
 coin return 99  
 cola 144  
 colander 68  
 cold 44, 286, 321  
 cold faucet 72  
 cold-pressed oil 135  
 collage 275  
 collar 32  
 collarbone 17  
 colleague 24  
 collect call 99  
 collection 98  
 college 168  
 cologne 41  
 Colombia 315  
 colony 315  
 colored pencil 163  
 colors 39, 274  
 comb 38  
 comb v 38  
 combat sports 236  
 combine 185  
 comedy 255  
 comforter 71  
 comet 280  
 comic 112  
 commis chef 152  
 commission 97  
 communications 98  
 commuter 208  
 Comoros 317  
 compact 40  
 compact car 199  
 company 175  
 compartment 209  
 compass 165, 312, 240  
 complaint 94  
 complexion 41  
 composite 181  
 compost 88  
 compost pile 85  
 computer 176  
 concealer 40  
 conceive v 20  
 conception 52  
 concert 255, 258  
 concourse 209  
 concrete block 187  
 concussion 46  
 condensed milk 136  
 conditioner 38  
 condom 21  
 conductor 256  
 cone 164, 187  
 confectionery 107, 113  
 confident 25  
 confused 25  
 conglomerate 288  
 Congo 317  
 conifer 86  
 connect v 177  
 connection 212  
 conning tower 215  
 console 269  
 constellation 281  
 construction 186  
 construction worker 186,  
     188  
 consultant 49  
 consultation 45  
 contact lenses 51  
 container 216, 311  
 container port 216  
 container ship 215  
 continent 282, 315  
 contraception 21, 52  
 contraction 52  
 control tower 212  
 controller 269  
 controls 201, 204  
 convenience food 107  
 convertible 199  
 conveyer belt 106  
 cooked meat 118, 143  
 cookies 113, 141  
 cooking 67  
 coolant reservoir 202  
 cooling rack 69  
 co-pilot 211  
 copper 289  
 copy v 172  
 cor anglais 257  
 coral reef 285  
 cordless drill 78  
 cordless phone 99  
 core 127  
 cork 134  
 corkscrew 150  
 corn 122, 130, 184  
 corn bread 139  
 corn oil 135  
 cornea 51  
 corner 223  
 corner flag 223  
 cornice 300  
 corset 35  
 Corsica 316  
 Costa Rica 314  
 costume 255  
 cottage cheese 136  
 cottage garden 84  
 cotton 184, 277  
 cotton balls 41  
 cough 44  
 cough drop 109  
 cough medicine 108  
 counselor 55  
 count v 165  
 counter 96, 98, 100,  
     142, 272  
 countertop 66  
 country 259, 315  
 couple 24  
 courier 99  
 courses 153  
 court 226  
 court case 180  
 court clerk 180  
 court date 180  
 courtroom 180  
 courtyard 58, 84  
 couscous 130  
 cousin 22  
 coverall 30  
 cow 185  
 cow's milk 136  
 crab 121, 295  
 cracked wheat 130  
 cradle 95  
 craft knife 82  
 crafts 275  
 cramp 239  
 cramps 44  
 cranberry 127  
 crane 187, 216, 292  
 crater 283  
 crayfish 121  
 cream 109, 137, 140,  
     157  
 cream cheese 136  
 cream pie 141  
 crease 225  
 credit card 96  
 creel 245  
 creeper 87  
 crème caramel 141  
 crème patisserie 140  
 crêpe 155, 157  
 crescent moon 280  
 crew 241  
 crew hatch 281  
 crib 74  
 cricket 225, 295  
 cricket ball 225  
 cricketer 225  
 crime 94  
 criminal 181  
 criminal record 181  
 crisp 127  
 crispbread 139, 156  
 crisper 67  
 Croatia 316  
 crochet 277  
 crochet hook 277  
 crockery 64  
 crockery and cutlery 65  
 crocodile 293  
 croissant 156  
 crop 39, 183  
 crop farm 183  
 crops 184  
 crossbar 207, 222, 235  
 cross-country skiing 247  
 cross-trainer 250  
 crosswalk 195  
 crow 292  
 crown 50  
 crucible 166  
 crushed 132  
 crust 139, 282  
 cry v 25  
 crystal healing 55  
 Cuba 314  
 cube 164  
 cucumber 125  
 cuff 32, 45  
 cufflink 36  
 cultivate v 91  
 cultivator 182  
 cumin 132  
 curb 298  
 cured 118, 159, 143  
 curler 38  
 curling 247  
 curly 39  
 currant 129  
 curry 158  
 curry powder 132  
 curtain 63, 254  
 curved 165  
 cushion 62  
 custard 140  
 customer 96, 104, 106,  
     152  
 customer service  
     department 175  
 customer services 104  
 customs 212  
 customs house 216  
 cut 46  
 cut v 38, 79, 277  
 cuticle 15  
 cutlery 64  
 cuts 119  
 cutting 91  
 cutting board 68  
 cuttlefish 121  
 cycle v 207  
 cycle lane 206  
 cycling 263  
 cylinder 164  
 cylinder head 202  
 cymbals 257  
 Cyprus 316  
 Czech Republic 316

**D**

- daffodil 111  
 dairy 107  
 dairy farm 183  
 dairy produce 136  
 daisy 110, 297  
 dam 300  
 dance 259  
 dance academy 169  
 dancer 191  
 dandelion 123, 297  
 dandruff 39  
 dark 41, 321  
 darkroom 271  
 darn v 277  
 dartboard 273  
 darts 273  
 dashboard 201  
 date 129, 306  
 daughter 22

- daughter-in-law 22  
dawn 305  
day 305, 306  
day after tomorrow 307  
day before yesterday 307  
dead ball line 221  
deadhead v 91  
deal v 273  
debit card 96  
decade 307  
decay 50  
December 306  
deciduous 86  
decimal 165  
deck 214  
deck chair 265  
deck of cards 273  
decking 85  
decorating 82  
decoration 141  
decorator 82  
deep end 239  
deep-fried 159  
deep-sea fishing 245  
deer 291  
defense 181, 220  
defendant 181  
defender 223  
defending zone 224  
defrost v 67  
degree 169  
delay 209  
deli 107  
delicatessen 142  
delivery 52, 98  
deltoid 16  
Democratic Republic of the Congo 317  
Denmark 316  
denomination 97  
denominator 165  
dental care 108  
dental floss 50, 72  
dental hygiene 72  
dental X-ray 50  
dentist 50, 189  
dentist's chair 50  
dentures 50  
deodorant 73, 108  
department 169  
department store 105  
departments 49  
departure lounge 213  
departures 213  
deposit v 96  
deposit slips 96  
depth 165  
dermatology 49  
descaled 121  
desert 285  
desiccated 129  
designer 191, 277  
desk 162, 172  
desktop 177  
dessert 153  
desserts 140  
dessert cart 152  
destination 213  
detached 58  
detective 94  
detergent 77  
detour 195  
deuce 230  
develop v 271  
diabetes 44  
diagonal 164  
dial v 99  
diameter 164  
diamond 273, 288  
diaper 75  
diaper bag 75  
diaper rash cream 74  
diaphragm 19, 21  
diarrhea 44, 109  
dice 272  
dictionary 163  
die v 26  
diesel 199  
diesel train 208  
difficult 321  
dig v 90, 227  
digestive 19  
digital 269  
digital (radio) 179  
digital camera 270  
digital projector 163  
digital radio 268  
dilation 52  
dill 133  
dimensions 165  
dimple 15  
dining car 209  
dining room 64  
dinner 64, 158  
dinner plate 65  
diopter 51  
diploma 169  
dipstick 202  
direct current 60  
directions 260  
director 254  
directory assistance 99  
dirt bike 205  
dirty laundry 76  
disabled parking 195  
discharged 48  
disconnected 99  
discus 234  
discuss v 163  
disembark v 217  
dishwasher 66  
disinfectant solution 51  
disposable 109  
disposable camera 270  
disposable diaper 30  
disposable razor 73  
dissertation 169  
distance 310  
distributor 203  
district 315  
dive 239  
dive v 238  
diver 238  
divide v 165  
divided by 165  
divided highway 195  
dividends 97  
divider 173, 194  
divorce 26  
Diwali 27  
DJ 179  
Djibouti 317  
do not bend v 98  
dock 214, 216  
dock v 217  
doctor 45, 189  
doctorate 169  
documentary 178  
dog 290  
dog-sledding 247  
doll 75  
dollhouse 75  
dolphin 290  
dome 300  
domestic flight 212  
Dominica 314  
Dominican Republic 314  
dominoes 273  
donkey 185  
door 196, 198, 209  
door chain 59  
door knob 59  
door knocker 59  
door lock 200  
doorbell 59  
doormat 59  
dormer 58  
dorsal fin 294  
dosage 109  
double 151  
double bass 256  
double bassoon 257  
double bed 71  
double room 100  
double-decker bus 196  
doubles 230  
dough 138  
Dover sole 120  
down 320  
downhill skiing 247  
download v 177  
dragonfly 295  
drain 61, 72, 299  
drain cock 61  
drainage 91  
draining board 67  
draw 223  
draw v 162  
drawer 66, 70, 172  
drawing 275  
dress 31, 34  
dressage 243  
dressed 159  
dressed chicken 119  
dressing 47, 158  
dressing table 71  
dribble v 223, 227  
dried flowers 111  
dried fruit 156  
drill 50  
drill v 79  
drill bit 78  
drill bits 80  
drinking cup 75  
drinking fountain 262  
drinks 107, 144, 156  
drip 53  
drive v 195, 233  
driver 196  
driver's seat 196  
driveshaft 202  
drop anchor v 217  
dropper 109, 167  
drops 109  
dropshot 230  
drown v 239  
drum 258  
drum kit 258  
drummer 258  
dry 39, 41, 130, 145, 286, 321  
dry v 76  
dry-cleaner 115  
dry dock 217  
DTV converter box 269  
duck 119, 185  
duck egg 137  
duckling 185  
duffle bag 37  
duffle coat 31  
dugout 229  
dumb bell 251  
dumper truck 187  
dunk v 227  
duodenum 18  
duplex 58  
dusk 305  
dust v 77  
dustpan 77  
duster 77  
dust sheet 83  
duty-free shop 213  
DVD 269  
DVD player 268  
dyed 39  
dynamo 207  
**E**  
eagle 292  
ear 14  
early  
earring 36  
Earth 280, 282  
earthenware dish 69  
earthquake 283  
easel 174, 274  
east 312  
East Timor 319  
Easter 27  
easy 321  
easy cook 130  
eat v 64  
eat-in 154  
eating 75  
eaves 58  
éclair 140  
eclipse 280  
economics 169  
economy class 211  
Ecuador 315  
eczema 44  
edam 142  
edge 246  
editor 191  
eel 294  
egg 20  
egg cup 65, 137  
egg white 137  
eggplant 125  
eggs 137  
Egypt 317  
eight 308  
eight hundred 308  
eighteen 308  
eighteenth 309  
eighth 309  
eightieth 309  
eighty 308  
ejaculatory duct 21  
El Salvador 314  
elbow 13  
electric blanket 71  
electric blood pressure monitor 45  
electric car 199  
electric drill 78  
electric guitar 258  
electric meter 60  
electric razor 73  
electric shock 46  
electric train 208  
electrical goods 105, 107  
electrician 188  
electricity 60  
elephant 291  
elevator 59, 100, 104  
eleven 308  
eleventh 309  
elm 296  
email 98, 177  
email account 177  
email address 177  
embarrassed 25  
embossed paper 83  
embroidery 277  
embryo 52  
emerald 288  
emergency 46

- emergency exit 210  
 emergency lever 209  
 emergency phone 195  
 emergency room 48  
 emergency services 94  
 emigrate *v* 26  
 emotions 25  
 employee 24  
 employer 24  
 empty 321  
 enamel 50  
 encore 255  
 encyclopedia 163  
 end 321  
 end zone 220  
 endive 123  
 endline 226  
 endocrine 19  
 endocrinology 49  
 energy-saving bulb (eco bulb) 60  
 engaged couple 24  
 engine 202, 204, 208, 210  
 engine room 214  
 engineering 169  
 English breakfast 157  
 English mustard 135  
 engraving 275  
 enlarge *v* 172  
 enlargement 271  
 ENT (otolaryngology) 49  
 entrance 59  
 entrée 153  
 envelope 98, 173  
 environment 280  
 epidural 52  
 epiglottis 19  
 epilepsy 44  
 episiotomy 52  
 equals 165  
 equation 165  
 equator 283  
 equipment 233, 238  
 equipment 165  
 Equatorial Guinea 317  
 equity 97  
 eraser 163  
 Eritrea 317  
 erupt *v* 283  
 escalator 104  
 esophagus 19  
 espresso 148  
 essay 163  
 essential oils 55  
 estate 199  
 Estonia 316  
 estuary 285  
 Ethiopia 317  
 eucalyptus 296  
 Europe 316  
 evening 305  
 evening dress 34  
 evening menu 152
- events 243, 247  
 evergreen 86  
 evidence 181  
 excavator 187  
 excess baggage 212  
 exchange rate 97  
 excited 25  
 excuse me 322  
 executive 174  
 exercise bike 250  
 exercises 251  
 exfoliate *v* 41  
 exhaust pipe 203, 204  
 exhibit *v* 261  
 exhibition 261  
 exit 210  
 exit ramp 194  
 exosphere 286  
 expanding file 173  
 expectant 52  
 experiment 166  
 expiration date 109  
 exposure 271  
 express train 209  
 extend *v* 251  
 extension 58  
 extension cord 78  
 exterior 198  
 external hard drive 176  
 extra time 223  
 extraction 50  
 extractor 66  
 eye 14, 51, 244, 276  
 eye shadow 40  
 eye test 51  
 eyebrow 14, 51  
 eyebrow brush 40  
 eyebrow pencil 40  
 eyecup 269  
 eyelash 14, 51  
 eyelet 37  
 eyelid 51  
 eyeliner 40  
 eyepiece 167
- F**  
 fabric 277  
 fabric conditioner 76  
 face 14  
 face cream 73  
 face mask 225  
 face pack 41  
 face powder 40  
 faceoff circle 224  
 facial 41  
 factory 299  
 faint *v* 25, 44  
 fair 41  
 fairground 262  
 fairway 232  
 falcon 292  
 Falkland Islands 315  
 fall 237  
 fall (autumn) 31, 307
- fall in love *v* 26  
 fallopian tube 50  
 family 22  
 famous ruin 261  
 fan 60, 202  
 fan belt 203  
 fans 258  
 far 320  
 fare 197, 209  
 farm 182, 183, 184  
 farmer 182, 189  
 farmhouse 182  
 farmland 182  
 farmyard 182  
 farsightedness 51  
 fashion 277  
 fast 321  
 fast food 154  
 fast-forward 269  
 fastening 37  
 fat 119, 321  
 fat-free 137  
 father 22  
 father-in-law 23  
 fault 230  
 fava beans 122, 131  
 fax 98, 172  
 fax machine 172  
 feather 293  
 feature film 269  
 February 306  
 feed *v* 183  
 feijoa 128  
 female 12, 20  
 feminine hygiene 108  
 femur 17  
 fence 85, 182, 243  
 fencing 249  
 feng shui 55  
 fennel 122, 133  
 fennel seeds 133  
 fenugreek 132  
 fern 86  
 ferry 215, 216  
 ferry terminal 216  
 fertilization 20  
 fertilize *v* 91  
 fertilizer 91  
 festivals 27  
 fetus 52  
 fever 44  
 fiancé 24  
 fiancée 24  
 fiancer 127  
 fibula 17  
 field 182, 222, 225, 228, 234, 258, 266  
 field *v* 225, 229  
 field hockey 224  
 fifteen 308  
 fifteenth 309  
 fifth 309  
 fiftieth 309  
 fifty 308
- fifty five thousand, five hundred 309  
 fifty thousand 309  
 fig 129  
 fighter plane 211  
 figure skating 247  
 figurine 260  
 Fiji 319  
 filament 60  
 file 81, 177  
 filing cabinet 172  
 fill *v* 82  
 filler 83  
 fillet 119, 121  
 filleted 121  
 filling 50, 140, 155  
 film chamber 270  
 film spool 271  
 filter 270  
 filter coffee 148  
 filter paper 167  
 fin 210  
 finance 97  
 financial advisor 97  
 fingerprint 94  
 finial 300  
 finish line 234  
 Finland 316  
 fire 95  
 fire alarm 95  
 fire department 95  
 fire engine 95  
 fire escape 95  
 fire extinguisher 95  
 fire station 95  
 firefighter 95, 189  
 firelighter 266  
 fireplace 63  
 firm 124  
 first 309  
 first aid 47  
 first-aid box 47  
 first night 254  
 fish 107, 120, 294  
 fish and chips 155  
 fish farm 183  
 fisherman 189  
 fishhook 244  
 fishing 244, 245  
 fishing boat 217  
 fishing permit 245  
 fishing port 217  
 fishing rod 244  
 fish-seller 114, 120, 188  
 fist 15, 237  
 fitness 250  
 five 308  
 five hundred 308  
 flag 221, 232  
 flageolet beans 131  
 flakes 132  
 flamingo 292  
 flan 142  
 flare 240
- flash 270  
 flash gun 270  
 flashlight 267  
 flask 166  
 flat 59, 256  
 flat race 243  
 flat tire 203, 207  
 flat wood bit 80  
 flatbread 139  
 flatscreen TV 269  
 flavored oil 134  
 flax 184  
 fleece 74  
 flesh 124, 127, 129  
 flex *v* 251  
 flight attendant 190, 210  
 flight number 213  
 flint 288  
 flipchart 174  
 flip-flop 37  
 flipper 239, 290  
 float 238, 244  
 float ball 61  
 flock 183  
 flood 287  
 floor 58, 62, 71  
 floor exercises 235  
 floor plan 261  
 florentine 141  
 foret 122  
 florist 110, 188  
 floss *v* 50  
 flours 138  
 flower 297  
 flowerbed 85, 90  
 flowering plant 297  
 flowering shrub 87  
 flowers 110  
 flu 44  
 flute 139, 257  
 fly 244, 295  
 fly *v* 211  
 fly-fishing 245  
 flysheet 266  
 foal 185  
 focus *v* 271  
 focusing knob 167  
 fog 287  
 foil 249  
 folder 177  
 foliage 110  
 folk music 259  
 follicle 20  
 font 177  
 food 118, 130, 149  
 food hall 105  
 food processor 66  
 foot 12, 15, 310  
 foot pedals (instrument) 257  
 football 220  
 footboard 71  
 footpath 262

formal 34  
 formal garden 84, 262  
 fortieth 309  
 forty 308  
 forty minutes  
 forward 222  
 foul 222, 226  
 foul ball 228  
 foul line 229  
 foundation 40  
 fountain 85  
 four 308  
 four hundred 308  
 four-door 200  
 fourteen 308  
 fourteenth 309  
 fourth 309  
 four-wheel drive 199  
 fox 290  
 foxglove 297  
 foyer 59  
 fraction 165  
 fracture 46  
 fragile 98  
 fragranced 130  
 frame 51, 62, 206, 230, 269  
 France 316  
 freckle 15  
 free 321  
 free kick 222  
 free-range 118  
 free weights 250  
 freesia 110  
 free-throw line 226  
 freeway 194  
 freeze 287  
 freeze v 67  
 freezer 67  
 freight train 208  
 freighter 215  
 French bean 122  
 French braid 39  
 french fries 154  
 French Guiana 315  
 French horn 257  
 French mustard 135  
 French toast 157  
 frequency 179  
 fresh 121, 127, 130  
 fresh cheese 136  
 fresh fruit 157  
 freshwater fishing 245  
 fret 258  
 fretsaw 81  
 Friday 306  
 fried 159  
 fried chicken 155  
 fried egg 157  
 friend 24  
 frieze 301  
 frog 294  
 from 320  
 front crawl 239

front door 58  
 front wheel 196  
 frontage road 194, 216  
 frontal 16  
 frost 287  
 froth 148  
 frown 25  
 frozen 121, 124  
 frozen food 107  
 frozen yogurt 137  
 fruit 107, 126, 128  
 fruit bread 139  
 fruit cake 140  
 fruit farm 183  
 fruit juice 127, 156  
 fruit tart 140  
 fruit yogurt 157  
 fry v 67  
 frying pan 69  
 fuel gauge 201  
 fuel tank 204  
 full 64, 266, 321  
 full board 101  
 full moon 280  
 fumble 220  
 funeral 26  
 funnel 166, 214  
 furniture store 115  
 furrow 183  
 fuse 60  
 fuse box 60, 203  
 fuselage 210

**G**

gable 300  
 Gabon 317  
 Galápagos Islands 315  
 galaxy 280  
 gale 286  
 galley 214  
 gallon 311  
 gallop 243  
 galvanized 79  
 Gambia 317  
 game 119, 230, 273  
 game show 178  
 games 272  
 gangway 214  
 garage 58, 199, 203  
 garbage can 61, 67  
 garbanzos 131  
 garden 84  
 garden center 115  
 garden features 84  
 garden pea 122  
 garden plants 86  
 garden styles 84  
 garden tools 88  
 gardener 188  
 gardening 90  
 gardening gloves 89  
 gardens 261  
 garland 111  
 garlic 125, 132

garlic press 68  
 garnet 288  
 garter 35  
 garter belt 35  
 gas burner 61  
 gas pump 199  
 gas station 199  
 gas tank 203  
 gasket 61  
 gasoline 199  
 gate 85, 182, 247  
 gate number 213  
 gauze 47, 167  
 gear lever 207  
 gearbox 202, 204  
 gears 206  
 gearshift 201  
 gel 38, 109  
 gems 288  
 generation 23  
 generator 60  
 genitals 12  
 geography 162  
 geometry 165  
 Georgia 318  
 gerbera 110  
 Germany 316  
 get a job v 26  
 get married v 26  
 get up v 71  
 geyser 285  
 Ghana 317  
 giant slalom 247  
 gift shop 114  
 gill 294  
 gin 145  
 gin and tonic 151  
 ginger 125, 133  
 giraffe 291  
 girder 186  
 girl 23  
 girlfriend 24  
 girth 242  
 glacier 284  
 gladiolus 110  
 gland 19  
 glass 69, 152  
 glass bottle 166  
 glass stirrer 167  
 glasses 51, 150  
 glassware 64  
 glaze v 139  
 glider 211, 248  
 gliding 248  
 gloss 83, 271  
 glove 224, 233, 236, 246  
 gloves 36  
 glue 275  
 glue gun 78  
 gneiss 288  
 go to bed v 71  
 go to sleep v 71  
 goal 221, 223, 224

goal area 223  
 goal line 220, 223, 224  
 goalkeeper 222, 224  
 goalpost 220, 222  
 goat 185  
 goat's cheese 142  
 goat's milk 136  
 goggles 238, 247  
 going out 75  
 gold 235, 289  
 goldfish 294  
 golf 232  
 golf bag 233  
 golf ball 233  
 golf cart 232, 233  
 golf clubs 233  
 golf course 232  
 golf shoe 233  
 golfer 232  
 gong 257  
 good 321  
 good afternoon 322  
 good evening 322  
 good morning 322  
 good night 322  
 goodbye 322  
 goose 119, 293  
 goose egg 137  
 gooseberry 127  
 gorge 284  
 gorilla 291  
 gothic 301  
 grade 163  
 graduate 169  
 graduate v 26  
 graduation ceremony 169  
 graft v 91  
 grains 130  
 gram 310  
 grandchildren 23  
 granddaughter 22  
 grandfather 22  
 grandmother 22  
 grandparents 23  
 grandson 22  
 granite 288  
 grape juice 144  
 grapefruit 126  
 grapeseed oil 134  
 graphite 289  
 grass 86, 262  
 grass bag 88  
 grasshopper 295  
 grassland 285  
 grate v 67  
 grated cheese 136  
 grater 68  
 gratin dish 69  
 gravel 88  
 gravity 280  
 gray 39, 274  
 graze 46  
 greasy 39

Greece 316  
 green 129, 232, 274  
 green olive 143  
 green onion 125  
 green peas 131  
 green salad 158  
 green tea 149  
 greenhouse 85  
 Greenland 314  
 Grenada 314  
 grill pan 69  
 grilled 159  
 grip 78  
 groceries 106  
 grocery store 114  
 groin 12  
 groom 243  
 ground 60, 132  
 ground coffee 144  
 ground cover 87  
 ground floor 104  
 ground meat 119  
 ground sheet 267  
 groundnut oil 135  
 group therapy 55  
 grout 83  
 guard 236  
 guard rail 195, 246  
 Guatemala 314  
 guava 128  
 guest 64, 100  
 guidebook 260  
 guided tour 260  
 guilty 181  
 Guinea 317  
 Guinea-Bissau 317  
 guitarist 258  
 gull 292  
 gum 50  
 gumdrop 113  
 gun 94  
 gutter 58, 299  
 guy rope 266  
 Guyana 315  
 gym 101, 250  
 gym machine 250  
 gymnast 235  
 gymnastics 235  
 gynecologist 52  
 gynecology 49  
 gypsophila 110

**H**

hacksaw 81  
 haddock 120  
 hail 286  
 hair 14, 38  
 hair dye 40  
 hairband 38  
 hairdresser 38, 115, 188  
 hair-dryer 38  
 hairpin 38  
 hairspray 38  
 Haiti 314

- half an hour 304  
 half-board 101  
 half-time 223  
 half-liter 311  
 halibut fillets 120  
 Halloween 27  
 hallway 59  
 halter 243  
 halter neck 35  
 ham 119, 143, 156  
 hammer 80  
 hammer v 79  
 hammock 266  
 hamper 263  
 hamster 290  
 hamstring 16  
 hand 13, 15  
 hand drill 81  
 hand fork 89  
 hand rail 59  
 hand saw 89  
 hand towel 73  
 handbag 37  
 handcuffs 94  
 handicap 233  
 handkerchief 36  
 handle 36, 88, 106, 187, 200, 230  
 handlebar 207  
 handles 37  
 handrail 196  
 handsaw 80  
 handset 99  
 hang v 82  
 hang-glider 248  
 hang-gliding 248  
 hanging basket 84  
 hanging file 173  
 happy 25  
 harbor 217  
 harbor master 217  
 hard 129, 321  
 hard candy 113  
 hard cheese 136  
 hard hat 186  
 hard shoulder 194  
 hardboard 79  
 hardware 176  
 hardware store 114  
 hardwood 79  
 haricot beans 131  
 harness race 243  
 harp 256  
 harvest v 91, 183  
 hat 36  
 hatchback 199  
 have a baby v 26  
 Hawaii 314  
 hay 184  
 hayfever 44  
 hazard 195  
 hazard lights 201  
 hazelnut 129  
 hazelnut oil 134  
 head 12, 19, 81, 230  
 head v 222  
 head injury 46  
 headache 44  
 headboard 70  
 headlight 198, 205  
 headphones 268  
 headquarters 175  
 headrest 200  
 headsail 240  
 health 44  
 health food store 115  
 heart 18, 119, 122, 273  
 heart attack 44  
 heater 60  
 heater controls 201  
 heather 297  
 heating element 61  
 heavy 321  
 heavy metal 259  
 hedge 85, 90, 182  
 hedgehog 290  
 heel 13, 15, 37  
 height 165  
 helicopter 211  
 hello 322  
 helmet 95, 204, 206, 220, 224, 228  
 helpdesk 168  
 hem 34  
 hematite 289  
 hemorrhage 46  
 hen's egg 137  
 herb 55, 86  
 herb garden 84  
 herbaceous border 35  
 herbal remedies 108  
 herbal tea 149  
 herbalism 55  
 herbicide 183  
 herbs 133, 134  
 herbs and spices 132  
 herd 183  
 hexagon 164  
 high 321  
 high chair 75  
 high-definition 269  
 high dive 239  
 high-heeled shoe 37  
 high jump 235  
 high speed train 208  
 highlights 39  
 hiking 263  
 hill 284  
 Himalayas 313  
 hip 12  
 hippopotamus 291  
 historic building 261  
 history 162  
 hit v 224  
 hockey 224  
 hockey stick 224  
 hoe 88  
 hold 215, 237  
 hole 232  
 hole in one 233  
 hole punch 173  
 holly 296  
 home 58  
 home delivery 154  
 home entertainment 268  
 home furnishings 105  
 home plate 228  
 homeopathy 55  
 homework 163  
 homogenized 137  
 Honduras 314  
 honeycomb 135  
 honeymoon 26  
 honeysuckle 297  
 hood 31, 75, 198  
 hoof 242, 291  
 hook 187, 276  
 hoop 226, 277  
 horizontal bar 235  
 hormone 20  
 horn 201, 204, 291  
 horror movie 255  
 horse 185, 235, 242  
 horse race 243  
 horseback riding 242, 263  
 horseradish 125  
 horseshoe 242  
 hose 89, 95  
 hose reel 89  
 hospital 48  
 host 64  
 hostess 64  
 hot 124, 286, 321  
 hot chocolate 144, 156  
 hot dog 155  
 hot-dog vendor 154  
 hot drinks 144  
 hot faucet 72  
 hot-air balloon 211  
 hotel 100, 264  
 hot-water bottle 70  
 hour 304  
 hour hand 304  
 house 58  
 household products 107  
 hovercraft 215  
 hub 206  
 hubcap 202  
 hull 214, 240  
 human resources 175  
 hiking 263  
 humerus 17  
 humid 286  
 hummingbird 292  
 hump 291  
 hundred 308  
 hundred and ten 308  
 hundred thousand 308  
 hundredth 309  
 Hungary 316  
 hungry 64  
 hurdles 235  
 hurricane 287  
 husband 22  
 husk 130  
 hydrant 95  
 hydrofoil 215  
 hydrotherapy 55  
 hypnotherapy 55  
 hypoallergenic 41  
 hypotenuse 164  
**I**  
 ice 120, 287  
 ice and lemon 151  
 ice bucket 150  
 ice climbing 247  
 ice cream 149  
 ice cube 151  
 ice hockey 224  
 ice hockey player 224  
 ice hockey rink 224  
 ice maker 67  
 ice cream 137  
 iced coffee 148  
 iced tea 149  
 ice-skate 224  
 ice-skating 247  
 Iceland 316  
 icicle 287  
 icing 141  
 icon 177  
 identity tag 53  
 igneous 288  
 ignition 200  
 iguana 293  
 illness 44  
 immigration 212  
 impotent 20  
 in 320  
 in brine 143  
 in front of 320  
 in oil 143  
 in sauce 159  
 in syrup 159  
 inbox 177  
 inch 310  
 incisor 50  
 incubator 53  
 index finger 15  
 India 318  
 Indian Ocean 312  
 indigo 274  
 Indonesia 319  
 induce labor v 53  
 industrial park 299  
 infection 44  
 infertile 20  
 infield 228  
 inflatable dinghy 215  
 information 261  
 information screen 213  
 in-goal area 221  
 inhaler 44, 109  
 injection 48  
 injury 46  
 ink 275  
 ink pad 173  
 inlet 61  
 inline skating 249  
 inner core 282  
 inner tube 207  
 inning 228  
 innocent 181  
 inoculation 45  
 insect repellent 108, 267  
 inside 320  
 insomnia 71  
 inspector 94  
 install v 177  
 instant camera 270  
 instep 15  
 instructions 109  
 instruments 256, 258  
 insulating tape 81  
 insulation 61  
 insulin 109  
 insurance 203  
 intensive care unit 48  
 interchange 194  
 intercom 59  
 intercostal 16  
 intercourse 20  
 interest rate 96  
 interior 200  
 internal systems 60  
 international flight 212  
 internet 177  
 intersection 298  
 interval 254  
 interviewer 179  
 into 320  
 in-tray 172  
 invertebrates 295  
 investigation 94  
 investment 97  
 ionosphere 286  
 iPod 268  
 iPad 176  
 Iran 318  
 Iraq 318  
 Ireland 316  
 iris 51, 110  
 iron 76, 109, 233, 289  
 iron v 76  
 ironing board 76  
 island 282  
 Israel 318  
 Italy 316  
 itinerary 260  
 IUD 21  
 Ivory Coast 317  
**J**  
 jack 203, 273  
 jacket 32, 34  
 jackhammer 187  
 jade 288  
 jam 134, 156  
 Jamaica 314

- jar 134, 311  
javelin 234  
jaw 14, 17  
jazz 259  
jeans 31, 33  
jelly bean 113  
jellyfish 295  
Jerusalem artichoke 125  
jet 288  
jet-skiing 241  
jetty 217  
jeweler 188  
jewelry store 114  
jewelry 36  
jewelry box 36  
jewelry-making 275  
jigsaw 78  
jigsaw puzzle 273  
jodhpurs 242  
jog in place 251  
jogging 251, 263  
jogging suit 31, 32  
joint 17, 119  
joker 273  
Jordan 318  
journal 168  
journalist 190  
judge 180  
judo 236  
jug 65  
juices and milkshakes 149  
juicy 127  
July 306  
jumbo shrimp 121  
jump 237, 243  
jump v 227  
jump ball 226  
jumping rope 251  
June 306  
Jupiter 280  
jury 180  
jury box 180
- K**  
kale 123  
kangaroo 291  
karate 236  
Karlíngrad 316  
kayak 241  
Kazakhstan 318  
kebab 155, 158  
keel 214  
keep net 244  
kendo 236  
Kenya 317  
kernel 122, 129, 130  
ketchup 135, 154  
kettle 66  
kettledrum 257  
key 59, 80, 176, 207  
keyboard 176, 258  
keypad 97, 99  
kick 237, 239
- kick v 221, 223  
kickboxing 236  
kickstand 207  
kid 185  
kidney 18, 119  
kilogram 310  
kilometer 310  
king 272, 273  
kippers 157  
kitchen 66, 152  
kitchen knife 68  
kitchenware 68, 105  
kitten 290  
kiwifruit 128  
knead v 138  
knee 12  
knee pad 205  
knee support 227  
kneecap 17  
knee-length 34  
knife 65, 80  
knife sharpener 68, 118  
knight 272  
knitting 277  
knitting needle 277  
knock out 237  
knuckle 15  
koala 291  
kohlrabi 123  
koi carp 294  
kumquat 126  
kung fu 236  
Kuwait 318  
Kyrgyzstan 318
- L**  
labels 89  
labia 20  
laboratory 166  
lace 35, 37  
lace bobbin 277  
lace-making 277  
lace-up 37  
lacrosse 249  
lactose 137  
ladder 95, 186  
ladle 68  
lady fingers 141  
ladybug 295  
lake 285  
lamb 118, 185  
lamp 62, 207, 217  
land 282  
land v 211  
landing 59  
landing gear 210  
landing net 244  
landlord 58  
landscape 271, 284  
landscape v 91  
lane 234, 238  
languages 162  
Laos 318  
lapel 32
- laptop 175  
larch 296  
large 321  
large intestine 18  
larynx 19  
last week 307  
lat 16  
late 305  
later 304  
latex paint 83  
latitude 283  
Latvia 316  
laugh v 25  
launch 281  
launch pad 281  
laundromat 115  
laundry 76  
laundry basket 76  
laundry service 101  
lava 283  
law 169, 180  
lawn 85, 90  
lawn rake 88  
lawnmower 88, 90  
lawyer 180, 190  
lawyer's office 180  
laxative 109  
lead singer 258  
leaded 199  
leaf 122, 296  
league 223  
lean meat 118  
learn v 163  
leather shoes 32  
leathers 205  
Lebanon 318  
lecture hall 169  
leek 125  
left 260  
left field 228  
left-hand drive 201  
leg 12, 119  
leg pad 225  
leg press 251  
legal advice 180  
legal department 175  
leggings 31  
legumes 130  
leisure 258, 254, 264  
lemon 126  
lemon curd 134  
lemon grass 133  
lemon sole 120  
lemonade 144  
length 165, 310  
lens 270  
lens (eye) 51  
lens (glasses) 51  
lens cap 270  
lens case 51  
Lesotho 317  
lesson 163  
let! 231  
letter 98
- letter slot 58, 99  
letterhead 173  
lettuce 123  
level 80, 187  
lever 61, 150  
Liberia 317  
librarian 168, 190  
library 168, 299  
library card 168  
Libya 317  
license plate 198  
liquor store 115  
licorice 113  
lid 61, 66  
Liechtenstein 316  
life events 26  
life jacket 240  
life preserver 240  
life raft 240  
lifeboat 214  
lifeguard 239, 265  
lifeguard tower 265  
ligament 17  
light 178, 321  
light a fire v 266  
light aircraft 211  
light bulb 60  
lighter 112  
lighthouse 217  
lighting 105  
lightmeter 270  
lightning 287  
lights 94  
lights switch 201  
lily 110  
lime 126, 296  
limestone 288  
limousine 199  
line 244  
line judge 220  
line of play 233  
linen 105, 277  
linen basket 76  
lines 165  
linesman 223, 230  
lingerie 35, 105  
lining 32  
lining paper 83  
link 36  
lintel 186  
lion 291  
lip 14  
lip brush 40  
lip gloss 40  
lip liner 40  
lipstick 40  
liqueur 145  
liquid 77  
liquid dispenser 311  
liquid measure 311  
liter 311  
literature 162, 169  
Lithuania 316  
little finger 15
- little toe 15  
live 60, 178  
live rail 209  
liver 18, 118  
livestock 183, 185  
living room 62  
lizard 293  
load v 76  
load line 214  
loaf 139  
loan 96, 168  
lob 230  
lobby 100, 255  
lobster 121, 295  
lock 59, 207  
lockers 239  
log on v 177  
loganberry 127  
logo 31  
loin 121  
lollipop 113  
long 32  
long jump 235  
long wave 179  
long-grain 130  
long-handled shears 88  
longitude 283  
loofah 73  
loom 277  
loose tea 144  
lose v 273  
loser 273  
lotion 109  
lottery tickets 112  
love 230  
low 321  
luge 247  
luggage 100, 198, 213  
luggage department 104  
luggage hold 196  
luggage rack 209  
lumbar vertebrae 17  
lunar module 281  
lunch 64  
lunch menu 152  
lung 18  
lunges 251  
lining 32  
lining paper 83  
link 36  
lintel 186  
lion 291  
lip 14  
lip brush 40  
lip gloss 40  
lip liner 40  
lipstick 40  
liqueur 145  
liquid 77  
liquid dispenser 311  
liquid measure 311  
liter 311  
literature 162, 169  
Lithuania 316  
little finger 15



- magazines 107  
 magma 283  
 magnesium 109  
 magnet 167  
 maid service 101  
 mail carrier 98, 190  
 mailbag 98, 190  
 mailbox 99  
 mainsail 240  
 make a will *v* 26  
 make friends *v* 26  
 make the bed *v* 71  
 makeup 40  
 making bread 138  
 malachite 288  
 Malawi 317  
 Malaysia 318  
 Maldives 318  
 male 12, 21  
 Mali 317  
 mallet 78, 275  
 malt vinegar 135  
 Malta 316  
 malted drink 144  
 mammals 290  
 man 23  
 manager 24, 174  
 manchego 142  
 mane 242, 291  
 mango 128  
 mangosteen 128  
 manhole 299  
 manicure 41  
 mantle 282  
 manual 200  
 map 261  
 maple 296  
 maple syrup 134  
 maracas 257  
 marathon 234  
 marble 288  
 March 306  
 margarine 137  
 marina 217  
 marinated 143, 159  
 marine fishing 245  
 marjoram 133  
 mark *v* 227  
 market 115  
 marketing department 175  
 marmalade 134, 156  
 marrow 124  
 Mars 280  
 marshmallow 113  
 martial arts 237  
 martini 151  
 marzipan 141  
 mascara 40  
 mashed 159  
 masher 68  
 mask 189, 228, 236, 239, 249  
 masking tape 83  
 masonry bit 80  
 massage 54  
 mast 240  
 masters 169  
 mat 54, 83, 235, 271  
 match 230  
 material 276  
 materials 79, 187  
 maternity 49  
 maternity ward 48  
 math 162, 164  
 mattress 70, 74  
 Mauritania 317  
 Mauritius 317  
 May 306  
 maybe 322  
 mayonnaise 135  
 MDF 79  
 meadow 285  
 meal 64  
 measles 44  
 measure 150, 151  
 measure *v* 310  
 measurements 165  
 measuring cup 69, 311  
 measuring spoon 109  
 meat 119  
 meat and poultry 106  
 meat tenderizer 68  
 meatballs 158  
 meathook 118  
 mechanic 188, 203  
 mechanics 202  
 medals 235  
 media 178  
 medical examination 45  
 medication 109  
 medicine 109, 169  
 medicine cabinet 72  
 meditation 54  
 Mediterranean Sea 313  
 medium wave 179  
 meeting 174  
 meeting room 174  
 melody 259  
 melon 127  
 memory 176  
 memory stick 176  
 men's clothing 32  
 menswear 105  
 menstruation 20  
 menu 148, 153, 154  
 menu bar 177  
 mercury 289  
 Mercury 280  
 meringue 140  
 mesosphere 286  
 messages 100  
 metacarpal 17  
 metal 79  
 metal bit 80  
 metals 289  
 metamorphic 288  
 metatarsal 17  
 meteor 280  
 meter 310  
 Mexico 314  
 mica 289  
 microphone 179, 258  
 microscope 167  
 microwave oven 66  
 midday 305  
 middle finger 15  
 midnight  
 midwife 53  
 migraine 44  
 mile 310  
 milk 136, 156  
 milk *v* 183  
 milk carton 136  
 milk chocolate 113  
 milkshake 137  
 millennium 307  
 millet 130  
 milligram 310  
 milliliter 311  
 millimeter 310  
 mineral 144  
 mineral spirits 83  
 minerals 289  
 mini bar 101  
 minibus 197  
 minivan 199  
 mini-dress 34  
 mint 113, 133  
 mint tea 149  
 minus 165  
 minute 304  
 minute hand 304  
 minutes 174  
 mirror 40, 71, 167  
 miscarriage 52  
 Miss 23  
 missile 211  
 mist 287  
 miter block 81  
 mitt 228  
 mittens 30  
 mix *v* 67, 138  
 mixing bowl 66, 69  
 mixing desk 179  
 moat 300  
 mobile 74  
 model 169, 190  
 model-making 275  
 modeling tool 275  
 moisturizer 41  
 molar 50  
 Moldova 316  
 mole 14  
 Monaco 316  
 Monday 306  
 money 97  
 money order 98  
 Mongolia 318  
 monitor 172  
 monitor 53  
 monkey 291  
 monkfish 120  
 monopoly 272  
 monorail 208  
 monsoon 287  
 month 306  
 monthly 307  
 monument 261  
 Moon 280  
 moonstone 288  
 moor *v* 217  
 mooring 217  
 mop 77  
 morning 305  
 Morocco 317  
 mortar 68, 167, 187  
 mortgage 96  
 mosque 300  
 mosquito 295  
 mosquito net 267  
 moth 295  
 mother 22  
 mother-in-law 23  
 motocross 249  
 motor 88  
 motor racing 249  
 motorcycle 204  
 motorcycle racing 249  
 molding 63  
 motor 88  
 mountain 284  
 mountain bike 206  
 mountain range 282  
 mouse 176, 290  
 mousse 141  
 mouth 14  
 mouth guard 237  
 mouthwash 72  
 move 273  
 movie 260, 271  
 movie set 179  
 movie theater 255, 299  
 mow *v* 90  
 Mozambique 317  
 mozzarella 142  
 Mr. 23  
 Mrs. 23  
 mudguard 205  
 muffin 140  
 muffin pan 69  
 muffler 203, 204  
 mug 65  
 mulch *v* 91  
 multigrain bread 139  
 multiply *v* 165  
 multivitamin tablets 109  
 mumps 44  
 mung beans 131  
 muscles 16  
 museum 261  
 mushroom 125  
 music 162  
 music school 169  
 musical 255  
 musical score 255  
 musical styles 259  
 musician 191  
 mussel 121, 295  
 mustard 155  
 mustard seed 131  
 Myanmar 318

**N**

- naan bread 139  
 nail 15, 80  
 nail clippers 41  
 nail file 41  
 nail polish 41  
 nail polish remover 41  
 nail scissors 41  
 Namibia 317  
 nape 13  
 napkin 65  
 napkin ring 65  
 narrow 321  
 nation 315  
 national park 261  
 natural 256  
 natural fiber 31  
 naturopathy 55  
 nausea 44  
 navel 12  
 navigate *v* 240  
 near 320  
 nearsightedness 51  
 nebula 280  
 neck 12, 258  
 neck brace 46  
 necklace 36  
 nectarine 126  
 needle 109, 276  
 needle plate 276  
 needlenose pliers 80  
 needlepoint 277  
 negative 271  
 negative electrode 167  
 neighbor 24  
 neoclassical 301  
 Nepal 318  
 nephew 23  
 Neptune 280  
 nerve 19, 50  
 nervous 19, 25  
 net 217, 222, 226, 227, 231  
 net *v* 245  
 net curtain 63  
 Netherlands 316  
 nettle 297  
 network 176  
 neurology 49  
 neutral 60

- neutral zone 224  
 new 321  
 new moon 280  
 new potato 124  
 New Year 27  
 New Zealand 319  
 newborn baby 53  
 news 178  
 newscaster 179, 191  
 newspaper 112  
 newsstand 112  
 next week 306  
 nib 163  
 Nicaragua 314  
 nickel 289  
 niece 23  
 Niger 317  
 Nigeria 317  
 night 305  
 nightgown 35  
 nightie 31  
 nightwear 31  
 nightstand 70  
 nightstick 94  
 nine 308  
 nine hundred 308  
 nineteen 308  
 nineteen hundred 307  
 nineteen hundred and one 307  
 nineteen ten 307  
 nineteenth 309  
 ninetieth 309  
 ninety 308  
 ninth 309  
 nipple 12  
 no 322  
 no entry 195  
 no right turn 195  
 no stopping 195  
 nonstick 69  
 noodles 158  
 normal 39  
 north 312  
 North and Central America 314  
 North Korea 318  
 North Pole 283  
 North Sea 312  
 Northern Hemisphere 283  
 Norway 316  
 nose 14, 210  
 nose clip 238  
 noseband 242  
 nosebleed 44  
 nosewheel 210  
 nostril 14  
 notation 256  
 note 97, 256  
 notecard 173  
 notepad 173  
 notebook 163, 172  
 notes 191  
 notice board 173  
 notions 105  
 nougat 113  
 November 306  
 now 304  
 nozzle 89  
 number 226  
 numbers 308  
 numerator 165  
 nurse 45, 48, 52, 189  
 nursery 74  
 nursing 53  
 nursing bra 53  
 nut 80  
 nutmeg 132  
 nuts 151  
 nuts and dried fruit 129  
 nylon 277
- O**  
 oak 296  
 oar 241  
 oatmeal 156  
 oats 130  
 objective lens 167  
 oboe 257  
 obsidian 288  
 obstetrician 52  
 occupations 188, 190  
 occupied 321  
 ocean 282  
 ocean liner 215  
 octagon 164  
 October 306  
 octopus 121, 295  
 odometer 201  
 offal 118  
 offers 106  
 office 24, 172, 174  
 office building 298  
 office equipment 172  
 office supplies 173  
 off-piste 247  
 off-side 223  
 oil 142, 199  
 oil paints 274  
 oil tank 204  
 oil tanker 215  
 oils 134  
 oily 41  
 ointment 47, 109  
 okra 122  
 old 321  
 olive oil 134  
 olives 151  
 Oman 318  
 omelet 158  
 on time 305  
 on top of 320  
 oncology 49  
 one 308  
 one billion 309  
 one million 309  
 one thousand 309  
 one-way 194  
 one-way system 298  
 onion 124  
 on-line 177  
 onto 320  
 onyx 289  
 opal 288  
 open 260, 321  
 open sandwich 155  
 open-top 260  
 opera 255  
 operating room 48  
 operation 48  
 operator 99  
 ophthalmology 49  
 opponent 236  
 opposite 320  
 optic 150  
 optic nerve 51  
 optician 51, 189  
 orange 126, 274  
 orange juice 148  
 orangeade 144  
 orbit 280  
 orchestra 254, 256  
 orchestra pit 254  
 orchid 111  
 order v 153  
 oregano 133  
 organic 91, 118, 122  
 organic waste 61  
 organizer 175  
 origami 275  
 ornamental 87  
 orthopedics 49  
 osteopathy 54  
 ostrich 292  
 otter 290  
 ounce 310  
 out 225, 228, 320  
 out of bounds 226  
 out of focus 271  
 outboard motor 215  
 outbuilding 182  
 outdoor activities 262  
 under core 282  
 outfield 229  
 outlet 61  
 outpatient 48  
 outside 320  
 out-tray 172  
 oval 164  
 ovary 20  
 oven 66  
 oven mitt 69  
 ovenproof 69  
 over 320  
 over par 233  
 overalls 30, 82  
 overdraft 96  
 overexposed 271  
 overflow pipe 61  
 overhead bin 210  
 overhead projector 163  
 overpass 194  
 overture 256  
 ovulation 20, 52  
 owl 292  
 oyster 121  
 ozone layer 286
- P**  
 Pacific Ocean 312  
 pack 311  
 pack of cigarettes 112  
 package 99, 311  
 pad 224  
 paddle 241  
 paddock 242  
 pads 53, 220  
 painkiller 109  
 painkillers 47  
 pail 77, 82, 265  
 paint 83  
 paint v 83  
 paint can 83  
 paint tray 83  
 painter 191  
 painting 62, 261, 274  
 paints 274  
 pajamas 33  
 pak-choi 123  
 Pakistan 318  
 palate 19  
 palette 274  
 pallet 186  
 palm 15, 86, 296  
 palm hearts 122  
 pan 310  
 pan-fried 159  
 Panama 314  
 pancreas 18  
 panda 291  
 panties 35  
 pants 32, 34  
 panty liner 108  
 papaya 128  
 paper clip 173  
 paper napkin 154  
 paper tray 172  
 papier-maché 275  
 paprika 132  
 Papua New Guinea 319  
 par 233  
 parachute 248  
 parachuting 248  
 paragliding 248  
 Paraguay 315  
 parallel 165  
 parallel bars 235  
 parallelogram 164  
 paramedic 94  
 parents 23  
 park 262  
 park v 195  
 parka 31, 33  
 parking brake 203  
 parking meter 195  
 parking lot 298  
 parmesan 142  
 parole 181  
 parrot 293  
 parsley 133  
 parsnip 125  
 partner 23  
 pass 226  
 pass v 195, 220, 223  
 passcode 99  
 passenger 216  
 passenger port 216  
 passion fruit 128  
 Passover 27  
 passport 213  
 passport control 213  
 pasta 158  
 pastels 274  
 pasteurized 137  
 pasting brush 82  
 pasting table 82  
 pastry 140, 149  
 pastry brush 69  
 pasture 182  
 patch 207  
 patchwork 277  
 pâté 142, 156  
 path 58, 85  
 pathology 49  
 patient 45  
 patio garden 85  
 pattern 276  
 pause 269  
 paving 85  
 pawn 272  
 pay v 153  
 pay-per-view channel 269  
 payphone 99  
 payment 96  
 payroll 175  
 peach 126, 128  
 peacock 293  
 peanut 129  
 peanut butter 135  
 peanuts 151  
 pear 127  
 peas 131  
 pecan 129  
 pectoral 16  
 pectoral fin 294  
 pedal 61, 206  
 pedal v 207  
 pedestrian zone 299  
 pediatrics 49  
 pedicure 41  
 pediment 301  
 peel v 67  
 peeled shrimp 120  
 pelican 292  
 pelvis 17  
 pen 163, 185  
 pen holder 172  
 pen pal 24

- penalty 222  
penalty area 223  
pencil 163, 275  
pencil case 163  
pencil sharpener 163  
pendant 36  
penguin 292  
peninsula 282  
penis 21  
pentagon 164  
peony 111  
people 12, 16  
pepper 64, 124, 152  
peppercorn 132  
pepperoni 142  
percentage 165  
percussion 257  
perennial 86  
perfume 41, 105  
pergola 84  
periodical 168  
perm 39  
perpendicular 165  
persimmon 128  
personal best 234  
personal organizer 173, 175  
personal trainer 250  
Peru 315  
pesticide 89, 183  
pestle 68, 167  
pet food 107  
pet store 115  
petal 297  
petri dish 166  
pharmacist 108, 189  
pharmacy 108  
pharynx 19  
pheasant 119, 293  
Phillips screwdriver 81  
philosophy 169  
Philippines 319  
photo album 271  
photo finish 234  
photographer 191  
photograph 271  
photograph v 271  
photography 270  
phyllo pastry 140  
physical education 162  
physics 162, 169  
physiotherapy 49  
piano 256  
piccolo 257  
pick v 91  
pick-and-mix 113  
pickax 187  
pickled 159  
pickup 258  
picnic 263  
picnic bench 266  
picture frame 271  
pie 158  
pie pan 69  
piece 272  
pier 217  
pies 143  
pig 185  
pig farm 183  
pigeon 292  
pigeonhole 100  
piglet 185  
pigsty 185  
pigtails 39  
Pilates 251  
pill 21, 109  
pillar 300  
pillion 204  
pillow 70  
pillowcase 71  
pilot 190, 211  
pin 60, 237, 249, 276  
PIN 96  
pincushion 276  
pine 296  
pine nut 129  
pineapple 128  
pineapple juice 149  
pink 274  
pint 311  
pinto beans 131  
pipe 112, 202  
pipe cutter 81  
pipette 167  
piping bag 69  
pistachio 129  
pita bread 139  
pitch v 229  
pitch a tent v 266  
pitcher 151, 229  
pitcher's mound 228  
pitches available 266  
pith 126  
pizza 154  
pizzeria 154  
place mat 64  
place setting 65  
placenta 52  
plain 285  
plane 81  
plane v 79  
planet 280, 282  
plant v 183  
plant pot 89  
plants 86, 296  
plaque 50  
plaster v 82  
plastic bag 122  
plastic pants 30  
plastic surgery 49  
plate 283  
plateau 284  
platform 208  
platform number 208  
platinum 289  
play 254, 269  
play v 229, 273  
player 221, 231, 273  
playground 263  
playhouse 75  
playing 75  
playpen 75  
plea 180  
please 322  
plow v 183  
plug 60, 72  
plum 126  
plumb line 82  
plumber 188  
plumbing 61  
plunger 81  
plus 165  
Pluto 280  
plywood 79  
poach v 67  
poached 159  
pocket 32  
pod 122  
podium 235, 256  
point 273  
poisoning 46  
poker 273  
Poland 316  
polar bear 291  
Polaroid camera 270  
pole 245, 282  
pole vault 234  
police 94  
police car 94  
police officer 94, 189  
police station 94  
polish 77  
polish v 77  
politics 169  
polo 243  
polyester 277  
pomegranate 128  
pommel 242  
pommel horse 235  
pond 85  
ponytail 39  
pool 249  
pop 259  
popcorn 255  
poplar 296  
popper 30  
poppy 297  
poppy seeds 138  
porch 58  
porch light 58  
pore 15  
pork 118  
pork 145, 176, 214, 216  
porter 100  
portfolio 97  
porthole 214  
portion 64  
portrait 271  
Portugal 316  
positive electrode 167  
post office 98  
postage 98  
postal worker 98  
postcard 112  
poster 255  
poster paint 274  
postgraduate 169  
postmark 98  
pot v 91  
potato 124  
potpourri 111  
potted plant 87, 110  
potter's wheel 275  
pottery 275  
potty 74  
pouch 291  
poultry 119  
poultry farm 183  
pound 310  
pour v 67  
powder 77, 109  
powder puff 40  
powdered milk 137  
power 60  
power cord 176  
power outage 60  
practice swing 233  
pram 75  
praying mantis 295  
pregnancy 52  
pregnancy test 52  
pregnant 52  
premature 52  
premolar 50  
prenatal 52  
prerecorded 178  
prescription 45  
present 27  
presentation 174  
presenter 178  
preservative 83  
preserved fruit 134  
press 178  
presser foot 276  
pressure valve 61  
price 152, 199  
price list 154  
prickly pear 128  
primer 83  
primrose 297  
principal 163  
principality 315  
print 271  
print v 172  
printer 172, 176  
printing 275  
prison 181  
prison guard 181  
private bathroom 100  
private jet 211  
private room 48  
probe 50  
problems 271  
processed grains 130  
procession 27  
processor 176  
produce stand 114, 188  
producer 254  
professor 169  
program 176  
program 254, 269  
programming 178  
propagate v 91  
propeller 211, 214  
proposal 174  
prosciutto 143  
prosecution 180  
prostate 21  
protractor 165  
proud 25  
prove v 139  
province 315  
prow 215  
prune 129  
prune v 91  
pruners 89  
psychiatry 49  
psychotherapy 55  
public address system 209  
puck 224  
pudding rice 130  
Puerto Rico 314  
puff pastry 140  
pull up v 251  
pulp 127  
pulse 47  
pumice 288  
pumice stone 73  
pump 37, 207  
pumpkin 125  
pumpkin seed 131  
punch 237  
punching bag 237  
pup 290  
pupil 51, 162  
puppy 290  
purple 274  
pushup 251  
purse 37  
putt v 233  
putter 233  
pyramid 164
- Q**  
Qatar 318  
quadriceps 16  
quail 119  
quail egg 137  
quart 311  
quarter of an hour 304  
quarterdeck 214  
quartz 289  
queen 272, 273  
question 163  
question v 163  
quiche pan 69

quilt 71  
 quilting 277  
 quince 128  
 quinoa 130  
 quiver 249

**R**

rabbit 118, 290  
 raccoon 290  
 race 234  
 race-car driver 249  
 racecourse 243  
 racehorse 243  
 racing bike 205, 206  
 racing dive 239  
 rack 166  
 racket 230  
 racket games 231  
 racquetball 231  
 radar 214, 281  
 radiator 60, 202  
 radiccchio 123  
 radio 179, 268  
 radio antenna 214  
 radio station 179  
 radiology 49  
 radish 124  
 radius 17, 164  
 rafter 186  
 rafting 241  
 rail 208  
 rail network 209  
 rain 287  
 rain gear 245, 267  
 rainbow 287  
 rainbow trout 120  
 raincoat 31, 32  
 rainforest 285  
 raisin 129  
 rake 88  
 rake v 90  
 rally 230  
 rally driving 249  
 RAM 176  
 Ramadan 26  
 ramekin 69  
 range 67  
 rap 259  
 rapeseed 184  
 rapids 240, 284  
 rappeling 248  
 rash 44  
 raspberry 127  
 raspberry jam 134  
 rat 290  
 rattle 74  
 raw 124, 129  
 ray 294  
 razor blade 73  
 razorshell clam 121  
 read v 162  
 reading light 210  
 reading list 168  
 reading room 168

reamer 80  
 rear light 207  
 rear wheel 197  
 rearview mirror 198  
 receipt 152  
 receive v 177  
 receiver 99  
 reception 100  
 receptionist 100, 190  
 record 234, 269  
 record player 268  
 record store 115  
 recording studio 179  
 rectangle 164  
 rectum 21  
 recycling bin 61  
 red 145, 274  
 red card 223  
 red-eye 271  
 red kidney beans 131  
 red lentils 131  
 red meat 118  
 red mullet 120  
 Red Sea 313  
 reduce v 172  
 reduced-fat milk 136  
 reel 244  
 reel in v 245  
 referee 222, 226  
 referral 49  
 reflector 50, 204, 207  
 reflector strap 205  
 reflexology 54  
 refrigerator 67  
 reggae 259  
 region 315  
 register 100  
 registered mail 98  
 regulator 239  
 reheat v 154  
 reiki 55  
 reins 242  
 relationships 24  
 relatives 23  
 relaxation 55  
 relay race 235  
 release v 245  
 remote control 269  
 Renaissance 301  
 renew v 168  
 rent 58  
 rent v 58  
 repair kit 207  
 reporter 179  
 reproduction 20  
 reproductive 19  
 reproductive organs 20  
 reptiles 293  
 research 169  
 reserve v 168  
 residence hall 168  
 respiratory 19  
 rest 256

restaurant 101, 152  
 result 49  
 resurfacing 187  
 resuscitation 47  
 retina 51  
 retire v 26  
 return 231  
 return address 98  
 return date 168  
 rewind 269  
 rhinoceros 291  
 rhombus 164  
 rhubarb 127  
 rhythmic gymnastics 235  
 rib 17, 119  
 rib cage 17  
 ribbon 27  
 ribbon 39, 111, 141, 235  
 ribs 155  
 rice 130, 158, 184  
 rice pudding 140  
 rider 242  
 riding boot 242  
 riding crop 242  
 riding hat 242  
 rigging 215, 240  
 right 260  
 right field 229  
 right-hand drive 201  
 rim 206  
 rind 119, 127, 136, 142  
 ring 36  
 ring binder 173  
 ring finger 15  
 ring ties 89  
 rings 235  
 rinse v 38, 76  
 ripe 129  
 rise v 139  
 river 284  
 road bike 206  
 road markings 194  
 road signs 195  
 roads 194  
 road work 187, 195  
 roast 158  
 roast v 67  
 roasted 129  
 roasting pan 69  
 robe 35, 38, 169  
 rock climbing 248  
 rock concert 258  
 rock garden 84  
 rocket 123  
 rocks 284, 288  
 Rocky Mountains 312  
 rococo 301  
 rodeo 243  
 roll 139, 311  
 roll v 67  
 roller 83, 187  
 roller coaster 262  
 roller shade 63  
 rollerblading 263

rolling pin 69  
 romance 255  
 Romania 316  
 romper 30  
 roof 58, 203  
 roof garden 84  
 roof tile 187  
 roof rack 198  
 rook 272  
 room 58  
 room key 100  
 room number 100  
 room service 101  
 rooms 100  
 rooster 185  
 root 50, 124, 296  
 rope 248  
 rose 89, 110, 145  
 rosé 145  
 rosemary 133  
 rotor blade 211  
 rotten 127  
 rough 232  
 round 237  
 round neck 33  
 roundabout 195  
 route number 196  
 router 78  
 row 210, 254  
 row v 241  
 rower 241  
 rowboat 214  
 rowing machine 250  
 rubber band 173  
 rubber boots 89  
 rubber ring 265  
 rubber stamp 173  
 ruby 288  
 ruck 221  
 rudder 210, 241  
 rug 63  
 rugby 221  
 ruler 163, 165  
 rum 145  
 rum and coke 151  
 rump steak 119  
 run 228  
 run v 228  
 running shoe 37  
 runway 212  
 rush 86  
 rush hour 209  
 Russian Federation 318  
 rutabaga 125  
 Rwanda 317  
 rye bread 138

**S**

sad 25  
 saddle 206, 242  
 safari park 262  
 safe 228  
 safety 75, 240  
 safety goggles 81, 167

safety pin 47  
 saffron 132  
 sage 133  
 Sahara Desert 313  
 sail 241  
 sailboat 215  
 sailing 240  
 sailor 189  
 salad 149  
 salamander 294  
 salami 142  
 salary 175  
 sales clerk 104, 188  
 sales department 175  
 salmon 120  
 salt 64, 152  
 salted 121, 129, 137, 143  
 San Marino 316  
 sand 85, 264  
 sand v 82  
 sandal 37  
 sandals 31  
 sandbox 263  
 sandcastle 265  
 sander 78  
 sandpaper 81, 83  
 sandstone 288  
 sandwich 155  
 sandwich counter 143  
 sanitary napkin 108  
 São Tomé and Príncipe 317  
 sapphire 288  
 sardine 120  
 Sardinia 316  
 satellite 281  
 satellite dish 269  
 satellite navigation 201  
 satnav 195  
 satsuma 126  
 Saturday 306  
 Saturn 280  
 sauce 134, 143, 155  
 saucepan 69  
 Saudi Arabia 318  
 sauna 250  
 sausage 155, 157  
 sausages 118  
 sauté v 67  
 save v 177, 223  
 savings 96  
 savings account 97  
 savory 155  
 saw v 79  
 saxophone 257  
 scaffolding 186  
 scale 121, 256, 294  
 scales 45, 53, 69, 98, 118, 166, 212, 293, 310  
 scallop 121  
 scalp 39  
 scalpel 167

- scan 48, 52  
 scanner 106, 176  
 scarecrow 184  
 scared 25  
 scarf 31, 36  
 schedule 197, 209, 261  
 schist 288  
 scholarship 169  
 school 162, 299  
 school bus 196  
 schoolbag 162  
 schoolboy 162  
 schoolgirl 162  
 schools 169  
 science 162, 166  
 science fiction movie  
   255  
 scientist 190  
 scissors 38, 47, 82, 276  
 scoop 68, 149  
 scooter 205  
 score 220, 256, 273  
 score a goal v 223  
 scoreboard 225  
 scorpion 295  
 scotch and water 151  
 scrabble 272  
 scrambled eggs 157  
 scrape v 77  
 scraper 82  
 screen 59, 97, 176, 255,  
   269  
 screw 80  
 screwdriver 80, 151  
 screwdriver bits 80  
 script 254  
 scrollbar 177  
 scrotum 21  
 scrub v 77  
 scrum 221  
 scuba diving 239  
 sculpting 275  
 sculptor 191  
 sea 264, 282  
 sea bass 120  
 sea bream 120  
 sea horse 294  
 sea lion 290  
 sea plane 211  
 seafood 121  
 seal 290  
 sealant 83  
 sealed jar 135  
 seam 34  
 seamstress 191  
 search v 177  
 seasonal 129  
 seasons 306  
 seat 61, 204, 209, 210,  
   242, 254  
 seat back 210  
 seat belt 198, 211  
 seat post 206  
 seating 254
- second 304, 309  
 second floor 104  
 second-hand 304  
 second-hand store 115  
 section 282  
 security 212  
 security bit 80  
 security guard 189  
 sedan 199  
 sedative 109  
 sedimentary 288  
 seed 122, 127, 128, 130  
 seed tray 89  
 seeded bread 139  
 seedless 127  
 seedling 91  
 seeds 88, 131  
 seasaw 263  
 segment 126  
 self-defense 237  
 self-rising flour 139  
 self-tanning cream 41  
 semi-hard cheese 136  
 seminal vesicle 21  
 semi-soft cheese 136  
 semisweet chocolate  
   113  
 semolina 130  
 send v 177  
 send off 223  
 Senegal 317  
 sensitive 41  
 sentence 181  
 September 306  
 series 179  
 serve 231  
 serve v 64, 231  
 server 176  
 service included 152  
 service line 230  
 service not included 152  
 service provider 177  
 service vehicle 212  
 serving spoon 68  
 sesame seed 131  
 sesame oil 134  
 set 178, 230, 254  
 set v 38  
 set honey 134  
 set sail v 217  
 set the alarm v 71  
 set the table v 64  
 seven 308  
 seven hundred 308  
 seventeen 308  
 seventeenth 309  
 seventh 309  
 seventieth 309  
 seventy 308  
 sew v 277  
 sewing basket 276  
 sewing machine 276  
 sexually transmitted  
   disease 20
- shade 41  
 shade plant 87  
 shallot 125  
 shallow end 239  
 shampoo 38  
 shapes 164  
 share price 97  
 shares 97  
 shark 294  
 sharp 256  
 shaving 73  
 shaving foam 73  
 shears 89  
 shed 84  
 sheep 185  
 sheep farm 183  
 sheep's milk 137  
 sheet 71, 74, 241  
 shelf 67, 106  
 shell 129, 137, 265, 293  
 shelled 129  
 shelves 66  
 sherbet 141  
 sherry 145  
 shiatsu 54  
 shield 88  
 shin 12  
 ship 214  
 ships 215  
 shipyard 217  
 shirt 33  
 shock 47  
 shocked 25  
 shoe department 104  
 shoe store 114  
 shoes 34, 37  
 shoot v 223, 227  
 shop 298  
 shopping 104  
 shopping bag 106  
 shopping center 104  
 shops 114  
 short 32, 321  
 short wave 179  
 short-grain 130  
 shorts 30, 33  
 shot 151  
 shotgun 234  
 shoulder 13  
 shoulder bag 37  
 shoulder blade 17  
 shoulder pad 35  
 shoulder strap 37  
 shout v 25  
 shovel 187  
 shower 72, 286  
 shower block 266  
 shower curtain 72  
 shower door 72  
 shower gel 73  
 shower head 72  
 showjumping 243  
 shuffle v 273  
 shutoff valve 61
- shutter 58  
 shutter release 270  
 shuttle bus 197  
 shuttlecock 231  
 shy 25  
 Siberia 313  
 Sicily 316  
 side 164  
 side effects 109  
 side mirror 198  
 side order 153  
 side plate 65  
 side-saddle 242  
 side street 299  
 sidedeck 240  
 sideline 220, 226, 230  
 sidewalk 298  
 sidewalk café 148  
 Sierra Leone 317  
 sieve 68, 89  
 sieve v 91  
 sift v 138  
 sigh v 25  
 sightseeing 260  
 sign 104  
 signal 209  
 signature 96, 98  
 silk 277  
 silo 183  
 silt 85  
 silver 235, 289  
 simmer v 67  
 Singapore 319  
 singer 191  
 single 151  
 single room 100  
 singles 230  
 sink 38, 60, 61, 66, 72  
 sinus 19  
 siren 94  
 sirloin steak 119  
 sister 22  
 sister-in-law 23  
 site manager's office 266  
 situp 251  
 six 308  
 six hundred 308  
 sixteen 308  
 sixteenth 309  
 sixth 309  
 sixtieth 309  
 sixty 308  
 skate 120, 247, 294  
 skate v 224  
 skate wings 120  
 skateboard 249  
 skateboarding 249, 263  
 skein 277  
 skeleton 17  
 sketch 275  
 sketch pad 275  
 skewer 68  
 ski 241, 246  
 ski boot 246
- ski jacket 246  
 ski jump 247  
 ski pole 246  
 ski run 246  
 ski slope 246  
 skier 246  
 skiing 246  
 skim milk 136  
 skin 14, 119, 128  
 skin care 108  
 skinned 121  
 skirt 30, 34  
 skull 17  
 skydiving 248  
 skyscraper 299, 300  
 slalom 247  
 slate 288  
 sledding 247  
 sledgehammer 187  
 sleeper 30  
 sleeping 74  
 sleeping bag 267  
 sleeping compartment  
   209  
 sleeping mat 267  
 sleeping pill 109  
 sleet 286  
 sleeve 34  
 sleeveless 34  
 slice 119, 139, 140, 230  
 slice v 67  
 sliced bread 138  
 slicer 139  
 slide 167, 263  
 slide v 229  
 sling 46  
 slip 35  
 slip-on 37  
 slippers 31  
 slope 284  
 slotted spatula 68  
 slotted spoon 68  
 Slovakia 316  
 Slovenia 316  
 slow 321  
 slug 295  
 small 321  
 small intestine 18  
 small of back 13  
 smartphone 176  
 smash 231  
 smile 25  
 smoke 95  
 smoke alarm 95  
 smoked 118, 121, 143,  
   159  
 smoked fish 143  
 smoking 112  
 snack bar 113, 148  
 snail 295

- snake 293  
snare drum 257  
sneeze 44  
snore *v* 71  
snorkel 239  
snout 293  
snow 287  
snowboarding 247  
snowmobile 247  
snowsuit 30  
soak *v* 130  
soap 73, 178  
soap dish 73  
soap 220, 222  
soccer field 220  
soccer player 220  
soccer player 222  
soccer uniform 31, 222  
socket 60, 80  
socket wrench 80  
socks 33  
soda bread 139  
soda water 144  
sofa 62  
sofaced 63  
soft 129, 321  
soft cheese 136  
soft drink 154  
soft drinks 144  
soft toy 75  
software 176  
softwood 79  
soil 85  
solar system 280  
solder 79, 80  
solder *v* 79  
soldering iron 81  
soldier 189  
sole 15, 37  
solids 164  
Solomon Islands 319  
soluble 109  
solvent 83  
Somalia 317  
somersault 235  
son 22  
sonata 256  
song 259  
son-in-law 22  
sorrel 123  
sorting unit 61  
soufflé 158  
soufflé dish 69  
sound boom 179  
sound technician 179  
soundtrack 255  
soup 153, 158  
soup bowl 65  
soup spoon 65  
sour 127  
sour cream 137  
sourdough bread 139  
south 312  
South Africa 317  
South Korea 318  
South Sudan 317  
Southern Hemisphere 283  
Southern Ocean 313  
souvenirs 260  
sow *v* 90, 183  
soybeans 131  
space 280  
space exploration 281  
space heater 60  
space shuttle 281  
space station 281  
space suit 281  
spade 88, 265, 273  
Spain 316  
spare tire 203  
spark plug 203  
sparkling 144  
sparring 237  
sparrow 292  
spatula 68, 167  
speaker 174, 176, 258, 268  
speaker stand 268  
spearfishing 245  
specials 152  
spectators 233  
speed limit 195  
speed skating 247  
speedboat 241  
speedometer 201, 204  
spell *v* 162  
sperm 20  
sphere 164  
spices 132  
spicy sausage 142  
spider 295  
spike *v* 90  
spikes 233  
spin 230  
spin *v* 76  
spin-dryer 76  
spinach 123  
spine 17  
spire 300  
spleen 18  
splint 47  
splinter 46  
split ends 39  
split peas 131  
spoke 207  
sponge 73, 74, 83  
sponge cake 140  
spool 245  
spoon 65  
sport fishing 245  
sports 105, 220, 236, 248  
sports car 198  
sports field 168  
sportcoat 33  
sportsman 191  
spotlight 259  
sprain 46  
spray 109  
spray *v* 91  
spray can 311  
spray bottle 89  
spring 71, 307  
spring balance 166  
spring greens 123  
springboard 235, 238  
sprinkler 89  
sprinter 234  
sprocket 207  
spy hole 59  
square 164, 165, 272, 299  
square foot 310  
square meter 310  
squash 231  
squat 251  
squid 121, 295  
squirrel 290  
Sri Lanka 318  
St. Kitts and Nevis 314  
St. Lucia 314  
St. Vincent and the Grenadines 314  
stable 185, 243  
stadium 223  
staff 175, 256  
stage 167, 254  
stages 23  
stainless steel 79  
stair gate 75  
staircase 59  
stake 90  
stake *v* 91  
stalk 122, 297  
stalls 254  
stamen 297  
stamp 98  
stamp collecting 273  
stamps 112  
stance 232  
stand 88, 205, 268  
stapler 173  
staples 173  
star 280  
star anise 133  
starfish 295  
starfruit 128  
start school *v* 26  
starter 153  
starting block 234, 238  
starting line 234  
state 315  
statement 180  
stationery 105  
steak 121  
steam *v* 67  
steam train 208  
steamed 159  
steepchase 243  
steel wool 81  
steering wheel 201  
stem 111, 112, 297  
stencil 83  
stenographer 181  
step machine 250  
stepdaughter 23  
stepfather 23  
stepladder 82  
stepmother 23  
stepson 23  
stereo 269  
stereo system 268  
sterile 47  
stern 240  
stethoscope 45  
stew 158  
stick 224, 249  
sticks 133  
still 144  
sting 46, 295  
stir *v* 67  
stir-fry 158  
stirrer 150  
stirrup 242  
stitch 277  
stitch selector 276  
stitches 52  
stock broker 97  
stock exchange 97  
stocking 35  
stocks 97, 110  
stomach 18  
stomachache 44  
stone 36, 275  
stone fruit 126  
stop 269  
stop button 197  
stopper 166  
stopwatch 234  
store directory 104  
stork 292  
storm 287  
stout 145  
straight 39, 165  
straight ahead 260  
straighten *v* 39  
straighteners 38  
strap 35  
strapless 34  
stratosphere 286  
straw 144, 154  
strawberry 127  
strawberry milkshake 149  
stream 285  
streaming 269  
street 298  
street corner 298  
street sign 298  
streetlight 298  
stress 55  
stretch 251  
stretcher 94  
strike 228, 237  
string 230, 258  
string of pearls 36  
string bean 122  
strings 256  
strip *v* 82  
stroke 44, 233, 239  
strokes 231  
stroller 75  
strong 321  
stub 96  
study 63, 162  
stuffed 159  
stuffed olive 143  
stump 225  
styles 39, 239, 301  
submarine 215  
subsoil 91  
substitute 223  
substitution 223  
subtract *v* 165  
suburb 299  
subway map 209  
subway train 209  
succulent 87  
suction hose 77  
Sudan 317  
sugarcane 184  
suit 273  
sulfur 289  
summer 31, 307  
summons 180  
sumo wrestling 237  
Sun 280  
sun hat 30, 265  
sunbathe *v* 264  
sunbed 41  
sunblock 108, 265  
sunburn 46  
Sunday 306  
sunflower 184, 297  
sunflower oil 134  
sunflower seed 131  
sunglasses 51, 265  
sunny 286  
sunrise 305  
sunroof 202  
sunscreen 108  
sunset 305  
sunshine 286  
suntan lotion 265  
supermarket 106  
supersonic jet 211  
supplement 55  
supply pipe 61  
support 187  
suppository 109  
surf 241  
surfboard 241  
surfcasting 245  
surfer 241  
surfing 241  
surgeon 48  
surgery 45, 48  
Suriname 315  
surprised 25

- suspect 94, 181  
suspension 203, 205  
swallow 292  
swamp 285  
swan 293  
Swaziland 317  
sweater 33  
sweatshirt 33  
Sweden 316  
sweep *v* 77  
sweet 124, 127, 155  
sweet potato 125  
sweet spreads 134  
sweetcorn 124  
swim *v* 238  
swimmer 238  
swimming 238  
swimming pool 101, 238, 250  
swimsuit 238, 265  
swing *v* 232  
swings 263  
swiss chard 123  
switch 60  
Switzerland 316  
swivel chair 172  
sword 236  
swordfish 120, 294  
symphony 256  
synagogue 300  
synchronized swimming 239  
synthetic 31  
Syria 318  
syringe 109, 167  
syrup 109  
system 176
- T**  
tab 173  
table 64, 148  
table tennis 231  
tablecloth 64  
tachometer 201  
tack *v* 241, 277  
tackle 245  
tackle *v* 220, 223  
tackle box 244  
tadpole 294  
tae kwon do 236  
tag *v* 229  
tai chi 236  
tail 121, 210, 242, 280, 290, 294  
tailbone 17  
tailgate 198  
taillight 204  
tailor 191  
tailored 35  
tailor's 115  
tailor's chalk 276  
tailor's dummy 276  
tailplane 210  
Taiwan 319
- Tajikistan 318  
take a bath *v* 72  
take a shower *v* 72  
take notes *v* 163  
take off *v* 211  
talcum powder 73  
tall 321  
tambourine 257  
tampon 108  
tan 41  
tandem 206  
tangerine 126  
tank 61  
Tanzania 317  
tap 61, 66  
tap water 144  
tape deck 268  
tape dispenser 173  
tape measure 80, 276  
target 249  
target shooting 249  
taro root 124  
tarragon 133  
Tasmania 319  
tattoo 41  
tax 96  
taxi stand 213  
tea 144, 149, 184  
tea bag 144  
tea with lemon 149  
tea with milk 149  
teacher 162, 191  
teacup 65  
team 220, 229  
teapot 65  
tear 51  
teaspoon 65  
teat 75  
techniques 79, 159  
teddy bear 75  
tee 233  
teeing ground 232  
teenager 23  
tee off *v* 233  
telegram 98  
telephone 99  
telephone booth 99  
teleprompter 179  
telescope 281  
television 268  
television series 178  
television studio 178  
temperature 286  
temperature gauge 201  
temple 14, 300  
ten 308  
ten thousand 309  
tenant 58  
tend *v* 91  
tendon 17  
tennis 230  
tennis court 230  
tennis shoes 231  
tenon saw 81
- tent 267  
tent peg 266  
tent pole 266  
tenth 309  
tequila 145  
terminal 212  
termite 295  
terrace café 148  
territory 315  
test 49, 163  
test tube 166  
testicle 21  
text (SMS) 99  
text message 99  
textbook 163  
Thailand 318  
thank you 322  
Thanksgiving 27  
theater 254, 299  
theme park 262  
therapist 55  
thermal underwear 35  
thermals 267  
thermometer 45, 167  
thermosphere 286  
thermostat 61  
thesis 169  
thick 321  
thigh 12, 119  
thimble 276  
thin 321  
third 309  
third floor 104  
thirteen 308  
thirteenth 309  
thirtieth 309  
thirty 308  
this way up 98  
this week 307  
thistle 297  
thoracic vertebrae 17  
thread 276  
thread *v* 277  
thread guide 276  
thread reel 276  
three 308  
three hundred 308  
hatchback 200  
three-point line 226  
thriller 255  
throat 19  
throttle 204  
through 320  
throw 237  
throw *v* 221, 227, 229  
throw-in 223, 226  
thruster 281  
thumb 15  
thumbtack 173  
thunder 286  
Thursday 306  
thyme 133  
thyroid gland 18  
tibia 17
- ticket 209, 213  
ticket gate 209  
ticket inspector 209  
ticket office 209, 216  
tie 32  
tiebreaker 230  
tie-pin 36  
tiger 291  
tights 35, 251  
tile 58, 272  
tile *v* 82  
till 106, 150  
tiller 240  
timber 187  
time 234, 304  
time out 220  
timer 166  
times 165, 261  
timing 203  
tip 36, 122, 246  
tissue 108  
title 168  
titles 23  
to 320  
to go 154  
toad 294  
toast 157  
toasted sandwich 149  
toaster 66  
tobacco 112, 184  
today 306  
toddler 30  
toe 15  
toe clip 207  
toe strap 207  
toenail 15  
toffee 113  
toggle 31  
Togo 317  
toilet 61, 72  
toilet brush 72  
toilet paper 72  
toilet seat 72  
toiletries 41, 107  
toilets 104, 266  
toll booth 194  
tomato 125, 157  
tomato juice 144, 149  
tomorrow 306  
ton 310  
toner 41  
tongs 150, 167  
tongue 19, 37, 118  
tonic water 144  
tool rack 78  
toolbar 177  
toolbelt 186  
toolbox 80  
tools 187  
tooth 50  
toothache 50  
toothbrush 72  
toothpaste 72  
top coat 83
- top-dress *v* 90  
top tier 141  
topaz 288  
topiary 87  
topping 155  
topsoil 85  
tornado 287  
tortoise 293  
tossed salad 158  
touch line 221  
touchdown 221  
tour bus 197, 260  
tour guide 260  
tourer 205  
touring bike 206  
tourist 260  
tourist attraction 260  
tourist information 261  
tourmaline 288  
tournament 233  
tow away *v* 195  
tow truck 203  
toward 320  
towel bar 72  
towels 73  
tower 300  
town 298  
town hall 299  
townhouse 58  
toy 75  
toy basket 75  
toys 105  
track 208, 234  
track and field 234  
tractor 182  
traffic 194  
traffic jam 195  
traffic light 194  
traffic police 195  
trailer 266  
train 35, 208  
train *v* 91, 251  
train station 208  
trainer 37  
training wheels 207  
tram 196, 208  
transfer 223  
transformer 60  
transmission 202  
transplant *v* 91  
transportation 194  
trapezium 164  
trapezius 16  
trash 177  
travel agent 190, 114  
travel brochure 212  
travel sickness pills 109  
traveler's check 97  
tray 152, 154  
tray-table 210  
tread 207  
tread water *v* 239  
treadmill 250  
treble clef 256

- triangle 164, 257  
triceps 16  
trifle 141  
trim v 39, 90  
trimester 52  
trimmer 88  
Trinidad and Tobago 314  
tripod 166, 270, 281  
trolley bus 196  
trombone 257  
tropic of Cancer 283  
tropic of Capricorn 283  
tropical fruit 128  
tropics 283  
troposphere 286  
trot 243  
trough 183  
trout 120  
trowel 89, 187  
truck 194  
truck driver 190  
truffle 113, 125  
trumpet 257  
trunk 198, 291, 296  
trunks 238  
try 221  
T-shirt 30, 33  
tub 311  
tuba 257  
tube 311  
Tuesday 306  
tugboat 215  
tulip 111  
tumble 235  
tumble-dryer 76  
tumbler 65  
tuna 120  
tune v 179  
tune the radio v 269  
tuning peg 258  
Tunisia 317  
turbocharger 203  
turf v 90  
Turkey 316  
turkey 119, 185, 293  
Turkmenistan 318  
turmeric 132  
turn 238  
turn v 79  
turn off the television v 269  
turn on the television v 269  
turn signal 198, 204  
turnip 124  
turpentine 83  
turquoise 289  
turret 300  
turtle 293  
tusk 291  
tutu 191  
tweezers 40, 47, 167  
twelfth 309  
twelve 308  
twentieth 309  
twenty 308  
twenty minutes 304  
twenty thousand 309  
twenty-first 309  
twenty-one 308  
twenty-second 309  
twenty-third 309  
twenty-two 308  
twig 296  
twin bed 71  
twin room 100  
twine 89  
twins 23  
twist ties 89  
two 308  
two hundred 308  
two o'clock 304  
two thousand 307  
two thousand and one 307  
two-door 200  
types 199, 205  
types of buses 196  
types of cameras 270  
types of farms 183  
types of plants 86  
types of fishing 245  
types of trains 208  
tire 198, 205, 206  
tire iron 207  
tire pressure 203
- U**  
Uganda 317  
ugli fruit 126  
Ukraine 316  
ulna 17  
ultralight 211  
ultrasound 52  
ultraviolet rays 286  
umbilical cord 52  
umbrella 36, 233  
umbrella stand 59  
umpire 225, 229, 230  
uncle 22  
unconscious 47  
uncooked meat 142  
under 320  
under par 233  
undercoat 83  
underexposed 271  
undergraduate 169  
underpass 194  
underwear 32, 35  
underwired 35  
uniform 94, 189  
United Arab Emirates 318  
United Kingdom 316  
United States of America 314  
universe 280  
university 299  
unleaded 199  
unpasteurized 137  
unpick v 277  
unsalted 137  
until 320  
up 320  
upset 25  
Uranus 280  
ureter 21  
urethra 20  
urinary 19  
urology 49  
Uruguay 315  
usher 255  
uterus 20, 52  
utility knife 81  
utility room 76  
Uzbekistan 318
- V**  
vacation 212  
vacuum cleaner 77, 188  
vacuum cup 53  
vacuum flask 267  
vagina 20  
valance 71  
valley 284  
valve 207  
vanilla 132  
Vanuatu 319  
varnish 79, 83  
vas deferens 21  
vase 63, 111  
Vatican City 316  
vault 235, 300  
veal 118  
vegetable garden 85, 182  
vegetable oil 135  
vegetable peeler 68  
vegetables 107, 122, 124  
veggie burger 155  
veil 35  
vein 19  
venetian blind 63  
Venezuela 315  
venison 118  
vent 283  
Venus 280  
verdict 181  
vest 33, 35, 251  
veterinarian 189  
vibraphone 257  
video game 269  
video phone 99  
video tape 269  
Vietnam 318  
viewfinder 271  
village 299  
vine 183  
vinegar 135, 142  
vineyard 183  
vintage 199  
viola 256  
violin 256  
virus 44  
visa 213  
vise 78  
vision 51  
visiting hours 48  
visor 205  
vitamins 108  
V-neck 33  
vocal cords 19  
vodka 145  
voice message 99  
volcano 283  
volley 231  
volleyball 227  
voltage 60  
volume 165, 179, 269, 311  
vomit v 44
- W**  
waders 244  
wading pool 263  
waffles 157  
waist 12  
waistband 35  
waistcoat 33  
waiter 148, 152  
waiting room 45  
waitress 191  
wake up v 71  
walk 243  
walking boot 37, 267  
walkway 212  
wall 58, 186, 222  
wall light 62  
wallet 37  
wallpaper 82, 177  
wallpaper v 82  
wallpaper brush 82  
wallpaper paste 82  
walnut 129  
walnut oil 134  
walrus 290  
ward 48  
wardrobe 70  
warehouse 216  
warm 286  
warm up v 251  
warrant 180  
wash v 38, 77  
washer 80  
washer fluid 199  
washer fluid reservoir 202  
washing machine 76  
wasp 295  
waste disposal 61, 266  
waste disposal unit 61  
waste pipe 61  
wastebasket 172  
watch 36  
watch television v 269  
water 144, 238  
water v 90, 183  
water bottle 206, 267  
water chamber 61  
water chestnut 124  
water garden 84  
water hazard 232  
water heater 61  
water jet 95  
water plant 86  
water polo 239  
watercolor paints 274  
watercross 123  
waterfall 285  
watering 89  
watering can 89  
watermelon 127  
waterskier 241  
waterskiing 241  
watersports 241  
wave 241, 264  
wavelength 179  
wax 41  
weak 321  
weather 286  
weaving 277  
website 177  
wedding 26, 35  
wedding cake 141  
wedding dress 35  
wedding reception 26  
wedge 37, 233  
Wednesday 306  
weed v 91  
weedkiller 91  
weeds 86  
week 306  
weekend 306  
weekly 307  
weigh v 310  
weight 166, 244  
weight bar 251  
weight belt 239  
weight training 251  
wellington boots 31  
west 312  
western 255  
Western Sahara 317  
wet 286, 321  
wet wipe 75, 108  
wetsuit 239  
whale 290  
wheat 130, 184  
wheel 198, 207  
wheel nuts 203  
wheelbarrow 88  
wheelchair 48  
wheelchair access 197  
whetstone 81  
whiplash 46  
whipped cream 137  
whisk 68  
whisk v 67  
whiskers 290



- whiskey 145  
 white 39, 145, 272, 274  
 white bread 139  
 white chocolate 113  
 white coffee 148  
 white currant 127  
 white flour 138  
 white meat 118  
 white rice 130  
 whiting 120  
 whole 129, 132  
 whole milk 136  
 whole-grain 131  
 whole-grain mustard 135  
 whole-wheat bread 139  
 whole-wheat flour 138  
 wicket 225  
 wide 321  
 width 165  
 wife 22  
 Wifi 269  
 wig 39  
 wild rice 130  
 willow 296  
 win v 273  
 wind 241, 286  
 windbreak 265  
 windlass 214  
 window 58, 96, 98, 177,  
 186, 197, 209, 210  
 windpipe 18  
 windshield 198, 205  
 windshield wiper 198  
 windsurfer 241  
 windsurfing 241  
 windy 286  
 wine 145, 151  
 wine glass 65  
 wine list 152  
 wine vinegar 135  
 wing 119, 210, 293  
 wings 254  
 winner 273  
 winter 31, 307  
 winter sports 247  
 wipe v 77  
 wire 79  
 wire cutter 80  
 wire strippers 81  
 wires 60  
 with 320  
 withdrawal slip 96  
 without 320  
 witness 180  
 wok 69  
 wolf 290  
 woman 23  
 womb 52  
 women's clothing 34,  
 105  
 wood 79, 233, 275, 285  
 wood glue 78  
 wood shavings 78  
 wood stain 79  
 wooden spoon 68  
 woodpecker 292  
 woodwind 257  
 woodworking 275  
 wool 277  
 work 172  
 work day 306  
 workbench 78  
 workshop 78  
 world map 312  
 worm 295  
 worried 25  
 wound 46  
 wrap 155  
 wrapping 111  
 wreath 111  
 wrench 80, 81, 203  
 wrestling 236  
 wrinkle 15  
 wrist 13, 15  
 wristband 230  
 writ 180  
 write v 162  
**X**  
 X-ray 48  
 X-ray film 50  
 X-ray machine 212  
 X-ray viewer 45  
**Y**  
 yacht 215, 240  
 yam 125  
 yard 310  
 yawn v 25  
 year 163, 306  
 yeast 138  
 yellow 274  
 yellow card 223  
 Yemen 318  
 yes 322  
 yesterday 306  
 yoga 54  
 yogurt 137  
 yolk 137, 157  
 you're welcome 322  
 Yugoslavia 316  
**Z**  
 Zambia 317  
 zebra 291  
 zero 308  
 zest 126  
 Zimbabwe 317  
 zinc 289  
 zip 277  
 ZIP code 98  
 zone 315  
 zones 283  
 zoo 262  
 zoology 169  
 zoom lens 270  
 zucchini 125

## remerciements • acknowledgments

DORLING KINDERSLEY would like to thank Tracey Miles and Christine Lacey for design assistance, Georgina Garner for editorial and administrative help, Sonia Gavira, Polly Boyd, and Cathy Meeus for editorial help, and Claire Bowers for compiling the DK picture credits.

The publisher would like to thank the following for their kind permission to reproduce their photographs:

Abbreviations key: a-above; b-below/bottom; c-center; f-far; l-left; r-right; t-top)

**I23RF.com:** Andriy Popov 34tl; Daniel Ernst 179tc; Hongqi Zhang 24cla. 175cr; Ingvar Bjork 60c; Kobby Dagan 259c; leonardo255 269c; Liubov Vadimovna (Luba) Nel 39cla; Ljupco Smokovski 75crb; Oleksandr Marynchenko 60bl; Olga Popova 33c; oneblink 49bc; Racorn 162tl; Robert Churchill 94c; Roman Gorielov 33bc; Ruslan Kudrin 35bc, 35br; Subbotina 39cra; Sutichak Yachaingkhom 39tc; Tarzhanova 37tc; Vitaly Valua 39tl; Wavebreak Media Ltd 188bl; Wilawan Khasawong 75cb;  
**Action Plus:** 224bc; **Alamy Images:** 154t; A.T. Willett 287bcl; Alex Segre 105ca, 105cb, 195cl; Ambrophoto 24cra; Blend Images 168cr; Cultura RM 33r; Doug Houghton 107fbr; Ekkapon Sriharun 172bl; Hugh Threlfall 35tl; 176tr; Ian Allenden 48br; Ian Dagnall (iPod is a trademark of Apple Inc., registered in the U.S. and other countries) 268tc, 270t; Ievgen Chepil 250bc; imagebroker 199tl, 249c; Keith Morris 178c; Martyn Evans 210b; MBI 175tl; Michael Burrell 213cra; Michael Foyle 184bl; Oleksiy Maksymenko 105tc; Paul Weston 168br; Prisma Bildagentur AG 246b; Radharc Images 197tr; RBtravel 112tl; Ruslan Kudrin 176tl; Sasa Huzjak 258t; Sergey Kravchenko 37ca; Sergio Azenha 270bc; Stanca Sanda (iPod is a trademark of Apple Inc., registered in the U.S. and other countries) 176bc; Stock Connection 287bcr; tarczas 35cr; vityalysuprun 176cl; Wavebreak Media Ltd 39cl, 174b, 175tr; **Allsport/Getty Images:** 238cl; **Alvey and Towers:** 209acr, 215bcl, 215bcr, 241cr; **Peter Anderson:** 188cbr, 271br.  
**Anthony Blake Photo Library:** Charlie Stebbings 114cl; John Sims 114tcl; **Andyalt:** 98tl; **apple mac computers:** 268tr; **Arcaid:** John Edward Linden 301bl; Martine Hamilton Knight, Architects: Chapman Taylor Partners, 213cl; Richard Bryant 301br; **Argos:** 41tcl, 66cbl, 66cl, 66br, 66bcl, 69cl, 70bcl, 71t, 77tl, 269tc, 270tl; **Axiom:** Eitan Simanon 105bcr; Ian Cumming 104; Vicki Couchman 148cr; **Beken Of Cowes Ltd:** 215cb; **Bosch:** 76ctr, 76tc, 76tcl; **Camera Press:** 38tr, 256t, 257cr; Barry J. Holmes 148tr; Jane Hanger 159cr; Mary Germanou 259bc; **Corbis:** 78b; Anna Clopet 247tr; Ariel Skelley / Blend Images 52l; Bettmann 181tl, 181tr; Blue Jean Images 48bl; Bo Zauders 156t; Bob Rowan 152bl; Bob Winsett 247cbl; Brian Bailey 247br; Carl and Ann Purcell 162l; Chris Rainer 247ct; Craig Aurness 215bl; David H.Wells 249cbr; Dennis Marsico

274bl; Dimitri Lundt 236bc; Duomo 211tl; Gail Mooney 277ctr; George Lepp 248c; Gerald Nowak 239b; Gunter Marx 248cr; Jack Hollingsworth 231bl; Jacqui Hurst 277cbr; James L. Amos 247bl, 191ctr, 220bcr; Jan Butchofsky 277cb; Johnathan Blair 243cr; Jose F. Poblete 191br; Jose Luis Pelaez.Inc 153tc; Karl Weatherly 220bl, 247tr; Kelly Mooney Photography 259tl; Kevin Fleming 249bc; Kevin R. Morris 105tr, 243tl, 243tc; Kim Sayer 249tr; Lynn Goldsmith 258t; Macduff Everton 231bcl; Mark Gibson 249bl; Mark L. Stephenson 249ct; Michael Pole 115tr; Michael S. Yamashita 247ctcl; Mike King 247cbl; Neil Rabinowitz 214br; Pablo Corral 115bc; Paul A. Sounders 169br, 249ctcl; Paul J. Sutton 224c, 224br; Phil Schermeister 227b, 248tr; R. W Jones 309; Richard Morrell 189bc; Rick Doyle 241ctr; Robert Holmes 97br, 277ct; Roger Ressmeyer 169tr; Russ Schleipman 229; The Purcell Team 211ctr; Vince Streato 194t; Wally McNamee 220br, 220bcl, 224bl; Wavebreak Media LTD 191bc; Yann Arhus-Bertrand 249tl; **Demetrio Carrasco / Dorling Kindersley (c) Herge / Les Editions Casterman:** 112ccl; **Dorling Kindersley:** Banbury Museum 35c; Five Napkin Burger 152t; **Dixons:** 270cl, 270cr, 270bl, 270bcl, 270bcr, 270ccr; **Dreamstime.com:** Alexander Podshivalov 179tr, 191cr; Alexxl66 268tl; Andersastphoto 176tc; Andrey Popov 191bl; Arne9001 190tl; Chaos 26c; Designstock 269cl; Monkey Business Images 26clb; Paul Michael Hughes 162tr; Serghei Starus 190bc; **Education Photos:** John Walmsley 26tl; **Empics Ltd:** Adam Day 236br; Andy Heading 243c; Steve White 249cbr; **Getty Images:** 48bcl, 100t, 114bcr, 154bl, 287tr; 94tr; Don Farrall / Digital Vision 176c; Ethan Miller 270bl; Inti St Clair 179bl; Liam Norris 188br; Sean Justice / Digital Vision 24br; **Dennis Gilbert:** 106tc; **Hulsta:** 70t; **Ideal Standard Ltd:** 72r; **The Image Bank/Getty Images:** 58; **Impact Photos:** Eliza Armstrong 115cr; Philip Achache 246t; **The Interior Archive:** Henry Wilson, Alfie's Market 114bl; Luke White, Architect: David Mikhail, 59tl; Simon Upton, Architect: Philippe Starck, St Martins Lane Hotel 100bcr, 100br; **iStockphoto.com:** asterix0597 163tl; EdStock 190br; RichLegg 26bc; SorinVidis 27cr; **Jason Hawkes Aerial Photography:** 216t; **Dan Johnson:** 35r; **Kos Pictures Source:** 215cbl, 240tc, 240tr; David Williams 216b; **Lebrecht Collection:** Kate Mount 169bc; **MP Visual.com:** Mark Swallow 202t; **NASA:** 280cr, 280ccl, 281tl; **P&O Princess Cruises:** 214bl; **P A Photos:** 181br; **The Photographers' Library:** 186bl, 186bc, 186t; **Plain and Simple Kitchens:** 66t; **Powerstock Photolibrary:** 169tl, 256t, 287tc; **PunchStock:** Image Source 195tr; **Rail Images:** 208c, 208cbl, 209br; **Red Consultancy:** Odeon cinemas 257br; **Redferns:** 259br; Nigel Crane 259c; **Redx**

**Features:** 106br, 259tc, 259tr, 259bl, 280b; Charles Ommaney 114ctr; J.F.F Whitehead 243cl; Patrick Barth 101tl; Patrick Frilet 189cbl; Scott Wiseman 287bl; **Royalty Free Images:** Getty Images/Eyewire 154bl; **Science & Society Picture Library:** Science Museum 202b; **Science Photo Library:** IBM Research 190cla; NASA 281cr; **SuperStock:** Ingram Publishing 62; Juanma Aparicio / age fotostock 172t; Nordic Photos 269tl; **Skyscan:** 168t, 182c, 298; Quick UK Ltd 212; **Sony:** 268bc; **Robert Streeter:** 154br; **Neil Sutherland:** 82tr, 83tl, 90t, 118, 188ctr, 196t, 196tr, 299cl, 299bl; **The Travel Library:** Stuart Black 264t; **Travelex:** 97cl; **Vauxhall:** Technik 198t, 199tl, 199tr, 199cl, 199cr, 199ctcl, 199ctcr, 199ctcl, 199tr, 200; **View Pictures:** Dennis Gilbert, Architects: ACDP Consulting, 106t; Dennis Gilbert, Chris Wilkinson Architects, 209tr; Peter Cook, Architects: Nicholas Crimshaw and partners, 208t; **Betty Walton:** 185br; **Colin Walton:** 2, 4, 7, 9, 10, 28, 42, 56, 92, 95c, 99tl, 99tcl, 102, 116, 120t, 138t, 146, 150t, 160, 170, 191ctcl, 192, 218, 252, 260br, 260l, 261tr, 261c, 261cr, 271cbl, 271cbr, 271ctcl, 278, 287br, 302, 401.

## DK PICTURE LIBRARY:

Akhil Bahkshi; Patrick Baldwin; Geoff Brightling; British Museum; John Bulmer; Andrew Butler; Joe Cornish; Brian Cosgrove; Andy Crawford and Kit Houghton; Philip Dowell; Alistair Duncan; Gables; Bob Gathany; Norman Hollands; Kew Gardens; Peter James Kindersley; Vladimir Koziik; Sam Lloyd; London Northern Bus Company Ltd; Tracy Morgan; David Murray and Jules Selmes; Musée Vivant du Cheval, France; Museum of Broadcast Communications; Museum of Natural History; NASA; National History Museum; Norfolk Rural Life Museum; Stephen Oliver; RNLi; Royal Ballet School; Guy Ryecart; Science Museum; Neil Setchfield; Ross Simms and the Winchcombe Folk Police Museum; Singapore Symphony Orchestra; Smart Museum of Art; Tony Souter; Erik Svensson and Jeppe Wikstrom; Sam Tree of Keygrove Marketing Ltd; Barrie Watts; Alan Williams; Jerry Young.

Additional Photography by Colin Walton.

Colin Walton would like to thank:

A&A News, Uckfield; Abbey Music, Tunbridge Wells; Arena Mens Clothing, Tunbridge Wells; Burrells of Tunbridge Wells; Gary at Di Marco's; Jeremy's Home Store, Tunbridge Wells; Noakes of Tunbridge Wells; Ottakar's, Tunbridge Wells; Selby's of Uckfield; Sevenoaks Sound and Vision; Westfield, Royal Victoria Place, Tunbridge Wells.

All other images © Dorling Kindersley  
For further information see: [www.dkimages.com](http://www.dkimages.com)